

PROMODAY
2022

ITALIA € IVA ESCLUSA



CHIAVI DI MANOVRA

4



CHIAVI A BUSSOLA

8



GIRAVITI E PINZE

16



ELETTRONICA E ELETTROTECNICA

20



UTENSILI DINAMOMETRICI

22



UTENSILI DA TAGLIO

24



MANUTENZIONE GENERALE

26



LAMPADE

30



BORSE DA LAVORO

34



ARREDAMENTO FURGONI

40



ESTRATTORI

44



UTENSILI PNEUMATICI

46



CARRELLI E BANCHI DA LAVORO

54



ARREDAMENTO TECNICO

84



AUTOMOTIVE

88



PROFESSIONAL EQUIPMENT

108

Compatti

Durevoli

Potenti



I Prodotti

Ad ogni utensile un destinatario

Fasano Tools produce attrezzi ed utensili per professionisti, specialisti di settore e hobbisti innamorati della propria passione. Ogni prodotto è pensato per lo specifico ambito di riferimento, al fine di rendere lo strumento ancora più performante. Grazie all'ascolto del mercato, nel corso dei decenni l'azienda è stata capace di rinnovare costantemente l'offerta a catalogo, ed **oggi vanta più di 6.000 referenze suddivise in 17 famiglie di prodotto.**

Core Business



Il Target

Produciamo utensileria per professionisti di settori differenti che condividono un unico obiettivo: svolgere al meglio il proprio lavoro utilizzando gli strumenti migliori.



INDUSTRIA

Tools resistenti e garantiti, per raggiungere alti standard qualitativi.



ARTIGIANATO

I nostri utensili e attrezzi utili per i diversi settori dell'artigianato.



AUTOMOTIVE

Utensili unici e dedicati, studiati per risolvere qualsiasi sfida quotidiana.

Ricerca e Sviluppo

Nuove tecnologie a servizio del lavoro

Da sempre **Fasano Tools** è attenta alle nuove esigenze del mercato e si propone di offrire novità prodotta che siano peculiari per funzione, ma anche per design e tecnologia impiegata.

Per farlo, il reparto Ricerca e sviluppo è costantemente impegnato nello studio di **soluzioni innovative** che possano rendere il lavoro sempre più semplice ed i risultati ancora più efficienti.

Qualità e Assistenza

Gli utensili e gli attrezzi Fasano Tools soddisfano alti **standard qualitativi** e **garantiscono elevate prestazioni in termini di rendimento, durezza e relativa reiterazione delle azioni nel tempo.**

Fieri dei nostri prodotti, garantiamo la continua disponibilità di ricambi nel tempo, nonché un' **assistenza costante e puntuale.**



INNOVAZIONE TECNOLOGICA



DISPLAY DIGITALE

Visualizza in tempo reale la forza di compressione impressa sulla molla.



SISTEMA AUTOCENTRANTE

2 braccetti autocentranti che garantiscono il posizionamento ottimale e centrato dell'ammortizzatore, in sicurezza

LO SMONTA AMMORTIZZATORI

Fasano Tools ha superato i controlli di sicurezza previsti dalle **Direttive Europee** in materia di certificazione CE, affidandosi al prestigioso ente Internazionale TUV Sud.





CHIAVI DI MANOVRA



FG 600/SP6

SET 6 CHIAVI COMBinate POLIGONALI IN ROTOLO DI NYLON

CONTENUTO:
8, 10, 13, 14, 17, 19 mm

~~66,00€~~ 39,00€

FG 600/ST9

SET 9 CHIAVI COMBinate POLIGONALI CON SUPPORTO IN ABS

CONTENUTO:
8,10,11,12,13,14,15,17,19 mm

~~95,00€~~ 49,90€

FG 600/SC16

SET 16 CHIAVI COMBinate POLIGONALI

CONTENUTO:
6,7,8,10,12,13,14,16,
17,19,21,22,24,27,30,32 mm

~~222,00€~~ 119,00€

FG 600/SC25

SET 25 CHIAVI COMBinate POLIGONALI IN BOX DI CARTONE

CONTENUTO:
6, 7, 8, 9, 10, 11, 12, 13, 14, 15, 16,
17,18, 19, 20, 21, 22, 23, 24, 25, 26, 27,
28, 30,32 mm

~~360,00€~~ 199,00€

CHIAVE COMBINATA POLIGONALE EXTRA LUNA - DIN 3113



FG 600L/SC10

SET CHIAVI COMBinate POLIGONALI EXTRA LUNGHE IN BOX DI CARTONE

CONTENUTO:
10, 11, 12, 13, 14, 15, 16, 17, 18, 19 mm

~~148,00€~~ 89,00€



FG 602/SC13

SET CHIAVI A DOPPIA FORCHETTA IN BOX DI CARTONE

CONTENUTO:
6x7, 8x9, 10x11, 12x13, 14x15, 16x17,
18x19, 20x22, 21x23,
24x26, 25x28, 27x29, 30x32 mm

~~120,00€~~ 69,90€

CHIAVE POLIGONALE
DOPPIA CURVA - DIN 838



FG 615/SC8

SET CHIAVI COMBinate
POLIGONALI DOPPIE CURVE

CONTENUTO:

6x7, 8x9, 10x11, 12x13, 14x15, 16x17,
18x19, 20x22 mm

~~100,00€~~ 59,90€

CHIAVE PER RACCORDI
TUBO IN POLLICI- DIN 3118



FG 180/SP6

SET 6 CHIAVI PER RACCORDI
TUBO IN ROTOLO DI NYLON

CONTENUTO:

8x10, 10x11, 11x13,
12x14, 17x19, 19x22

~~115,00€~~ 69,00€

CHIAVI A TUBO,
MOD. PESANTE



FG 614A/S8

~~146,00€~~ 89,00€

SET CHIAVI A TUBO
MODELLO PESANTE

CONTENUTO:

6x7, 8x9, 10x11, 12x13, 14x15, 16x17,
18x19, 20x22

CHIAVI A T ESAGONALI
SEMPLICI

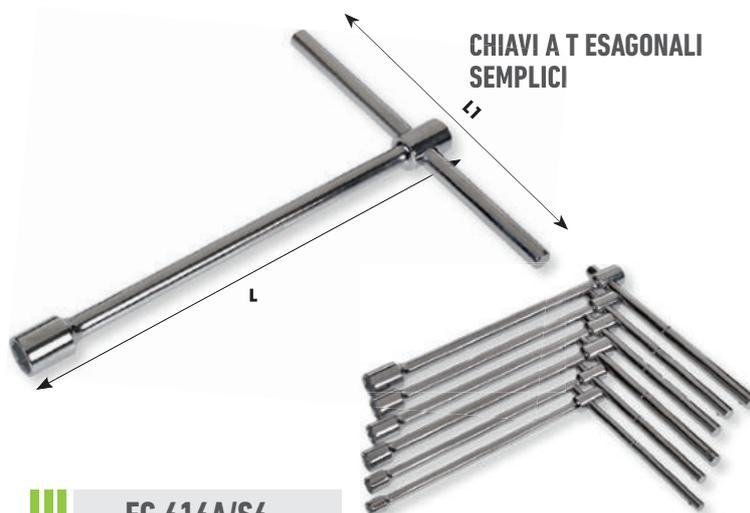

FG 616A/S6

SET 6 CHIAVI A T SEMPLICI
ESAGONALI

CONTENUTO:

8, 10, 12, 13, 14, 17mm

~~126,00€~~ 75,00€



FG 618/S7B

SET 7 CHIAVI A T
SNODATE ESAGONALI

CONTENUTO:

7, 8, 10, 12, 13, 14, 17mm

~~230,00€~~ 139,00€



FG 618/S7

SET 7 CHIAVI A T
SNODATE ESAGONALI

CONTENUTO:

8, 10, 11, 13, 14, 17, 19 mm

~~255,00€~~ 149,00€



FG 618/S10

SET 10 CHIAVI A T
SNODATE ESAGONALI

CONTENUTO:

8, 10, 11, 12, 13, 14,
15, 16, 17, 19 mm

~~375,00€~~ 219,00€



SNODO CARDANICO
ALTAMENTE
RINFORZATO



CHIAVI DI MANOVRA



ASTA SCORREVOLE



FG 621H/S8C

CHIAVI A T MASCHIO ESAGONALI
CON ASTA SCORREVOLE

CONTENUTO: 2,2.5,3,4,5,6,8,10mm

~~143,50€~~ 85,00€



ASTA SCORREVOLE



FG 621TX/S13

CHIAVI A T MASCHIO TORX

CONTENUTO: 6,7,8,9,10,15, 20,25,27,
30,40, 45,50 TX

~~225,00€~~ 129,00€

ASTA FISSA

SERIE
INDUSTRIA



FG 622H/S6

~~155,00€~~ 95,00€

SET CHIAVI A T MASCHIO
ESAGONALE

CONTENUTO: 2.5, 3, 4, 5, 6, 8mm

FG 622H/S7

~~195,00€~~ 119,00€

SET CHIAVI A T MASCHIO
ESAGONALE

CONTENUTO: 2.5, 3, 4, 5, 6, 8, 10mm



FG 615A/S6

SET 6 CHIAVI DOPPIE CON CRICCO
REVERSIBILE UNIVERSALE A 90 DENTI

CONTENUTO: 8x9, 10x11, 12x13, 14x15,
16x18, 17x19mm

~~130,00€~~ 69,00€



FG 622A/S6

~~130,00€~~ 72,00€

SET 6 CHIAVI A CRICCO UNIVERSALE
SERIE EXTRA-LUNGA

CONTENUTO: 8x9, 10x11, 12x13, 14x15, 16x18,
17x19 mm



FG 606/SP6

~~85,00€~~

51,50€

SET CHIAVI COMBinate NON REVERSIBILI IN ROTOLO DI NYLON

CONTENUTO: 8,10,13,14,17,19 mm



FG 610FL/SP9

~~210,00€~~

119,00€

SET 9 CHIAVI COMBinate A CRICCO FLESSIBILI IN ROTOLO DI NYLON

CONTENUTO: 8, 10, 12, 13, 15, 16, 17, 18, 19 mm



FG 605/SP6

~~98,00€~~

59,00€

SET 6 CHIAVI COMBinate REVERSIBILI IN ROTOLO DI NYLON

CONTENUTO:
8,10,13,14,17,19 mm



FG 605/SC12

~~182,00€~~

109,00€

SET 12 CHIAVI COMBinate A CRICCO REVERSIBILI IN BOX DI CARTONE

CONTENUTO:
8,9,10,11,12,13,14,15,16,17,18,19 mm

CHIAVE COMBinata A CRICCO REVERSIBILE CON ANELLO DI TENUTA

ANELLO IN ACCIAIO INTEGRATO CHE CONSENTE LA TENUTA DEL BULLONE

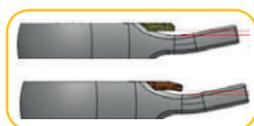

LEVA DI INVERSIONE A FILO TESTA E CON LINGUETTA INCLINATA VERSO IL BASSO PER UN MAGGIORE SPAZIO DI MANOVRA

FG 605/ST9-B

SET CHIAVI A CRICCO REVERSIBILI CON SUPPORTO IN ABS

CONTENUTO: 8,10,11,12,13,14,15,17,19mm

~~175,00€~~

99,00€

FG 605/ST11-B

SET CHIAVI A CRICCO REVERSIBILI CON SUPPORTO IN ABS

CONTENUTO: 8,9,10,11,12,13,14,15,16,17,19mm

~~215,00€~~

119,00€



CHIAVI A BUSSOLA

CRICCHETTO REVERSIBILE



FG 624/FR14 ~~39,00€~~ **22,90€**

CRICCHETTO REVERSIBILE DA 1/4"

- Modello con testa chiusa anti polvere
- Leva di inversione integrata a filo testa
- Corpo scavato di 13° per consentire l'utilizzo anche in spazi particolarmente difficoltosi
- Meccanismo a 72 denti
- Cromatura lucida e asola di aggancio

1/4"

FG 625/FR12 ~~55,00€~~ **31,90€**

CRICCHETTO REVERSIBILE DA 1/2"

- Modello con testa chiusa anti polvere
- Leva di inversione integrata a filo testa
- Corpo scavato di 13° per consentire l'utilizzo anche in spazi particolarmente difficoltosi
- Meccanismo a 72 denti
- Cromatura lucida
- Asola di aggancio

1/2"

FG 624/RT14 ~~55,00€~~ **32,90€**

CRICCHETTO REVERSIBILE DA 1/4"

- Sistema di avanzamento rotativo integrato nell'impugnatura
- Meccanismo a 60 denti
- Cromatura lucida e asola di aggancio

1/4"



FG 625/RT12 ~~72,00€~~ **42,90€**

- CRICCHETTO REVERSIBILE DA 1/2"
- CON IMPUGNATURA ROTANTE
- 60 DENTI

1/2"

FG 624/CR14 ~~37,00€~~ **21,90€**

CRICCHETTO REVERSIBILE DA 1/4"

- Sistema di inversione a ghiera integrato sulla testa
- Meccanismo a 72 denti
- Cromatura lucida
- Asola di aggancio

1/4"



FG 625/CR12 ~~50,00€~~ **27,90€**

- CRICCHETTO REVERSIBILE DA 1/2"
- MECCANISMO 72 DENTI

1/2"



FG 624/S11

SET 11 CHIAVI A BUSSOLA ESAGONALI SU SUPPORTO IN PLASTICA

CONTENUTO:

4, 5, 6, 7, 8, 9, 10, 11, 12, 13, 14 mm

~~42,80€~~ **24,90€**

FG 624TX/S17

SET 6 CHIAVI A BUSSOLA TX + 8 INSERTI A BUSSOLA TX E ACCESSORI

CONTENUTO:

BUSSOLE TX4, TX5, TX6, TX7, TX8, TX10
 INSERTI A BUSSOLA TX9, TX10, TX15, TX20, TX25, TX27,
 TX30, TX40
 PROLUNGA 1/4" - 100mm
 SNODO 1/4"
 + QUADRO MASCHIO 1/4"



~~76,80€~~ **39,00€**

FG 624/S25

SET 25 UTENSILI CON ATTACCO QUADRO 1/4"

~~80,80€~~ **45,00€**



FG 624/S45

SET 45 UTENSILI DA 1/4"

~~190,00€~~ **109,00€**



FG 624/E: 6, 8, 10, 11, 12, 13mm



FG 624/CR14



FG 89/38PI1 (1/4x1/4)



FG 85/25PH1, PH2, PH3

FG 85/25PZ1, PZ2, PZ3

FG 85/25F4, F5, F6, F7

FG 85/25TX10, TX15, TX20, TX25, TX30, TX40



FG 624/E4,5,6,7,8,9,10,11,12,13,14mm



FG 624/CR14



FG 624/PA50, 100

FG 624/PRF150

FG 624/ES14

FG 624/SN14



FG 624/GR14C

FG 148/H1.5-H10 / FG 148/TX8-TX40

FG 148/PH1-PH4 / FG 148/F1-F5



CHIAVI A BUSSOLA



FG 625/S27

~~170,00€~~



95,00€

SET 27 UTENSILI DA 1/2"



FG 625/A8,9,10,11,12,13,14,15,16,17,18,19,20,21,22,23,24,25,26,27,30,32



FG 625/CR12



FG 625/SN12



FG 625/ES12



FG 625/PA125, 250

1/2"

STRUTTURA RIGIDA IN ABS AD ALTA RESISTENZA



2 CLIP DI
CHIUSURA
IN ACCIAIO

DESIGN
BICOLORE

FG BEST 108



FG BEST 108

270,00€

139,00€

SET 108 UTENSILI DA 1/4" 1/2"

1/4"

1/2"



FG 625/SN12
FG 624/SN14



FG 625/ES12
FG 624/ES14



FG 624/GR14



FG 625/PR125
FG 624/PR50,100



FG 625/A10,11,12,13,14,15,16,
17,18,19,20,21,22,23,24,27,30,32



FG 624/E4,4.5,5.5,6,7,8,9,10,11,12,13,14



FG 625/L/A14,15,17,19,22



FG 624E/L6,7,8,9,10,11,12,13



FG 625/TX10,11,12,14,16,18,20,24



FG 624/TX4,5,6,7,8



FG 87/AD



FG 181/B16,21 x CANDELE ACCENSIONE



FG 624/CR14
FG 625/CR12



FG 139/D1.5,2.2,5



FG 147/PH1,PH2
FG 147/PZ1,PZ2
FG 147/SL4,SL5.5,SL6.5
FG 147/H3,H4,H5,H6
FG 147/TX10,TX15,TX20,TX25,TX30



FG 85/PH3,PH4
FG 85/PZ3,PZ4
FG 85/SL8,SL10,SL12
FG 85/H7,H8,H10,H12,H14
FG 85/TX40,TX45,TX50,TX55,TX60



CERNIERA
CON PERNO
IN ACCIAIO





CHIAVI A BUSSOLA

1/4"

3/8"

1/2"



FG BEST 171

SET 171 UTENSILI DA 1/4", 3/8" E 1/2"

~~380,00€~~

169,00€

FG BEST 171



FG 625/A10,11,12,13,14,15,16,
17,18,19,20,21,22,23,24,27,30,32



FG 624/B10,11,12,13,14,15,16,17,18,19



FG 624/E4,4,5,5,5,6,7,8,9,10,11,12,13,14



FG 625L/A16,17,18,19,22
FG 624B/L10,11,12,13,14,15
FG 624/4,5,6,7,8,9,10



FG 625/TX20,24
FG 624B/TX10,11,12,14,16,18
FG 624/TX4,5,6,7,8



FG 181/B16,21 x CANDELE ACCENSIONE



FG 87/AD



FG 181/B16,21 x CANDELE ACCENSIONE



FG 624/CR14
FG 624/CR38
FG 625/CR12



FG 625/SN12
FG 624/CR38
FG 624/SN14



FG 625/ES12
FG 624/ES14



FG 624/GR14



FG 625/PR125
FG 624B/PR125
FG 624/PR50,PR100



FG 139/D1,1.5,2,2.5,3,4,4.5,5



FG 147/PH0,PH1,PH2
FG 147/PZ0,PZ1,PZ2
FG 147/SL4,5,5,6,5,7
FG 147/H3,H4,H5
FG 147/TX8-TX30
FG 147/RTX8-RTX30



FG 85/PH3,PH4
FG 85/PZ3,PZ4
FG 85/SL8,SL10,SL12
FG 85/H7,H8,H10,H12,H14
FG 85/TX40-TX50
FG 85/TT10-TT45
FG 85/M5-M9



1/4"

1/2"

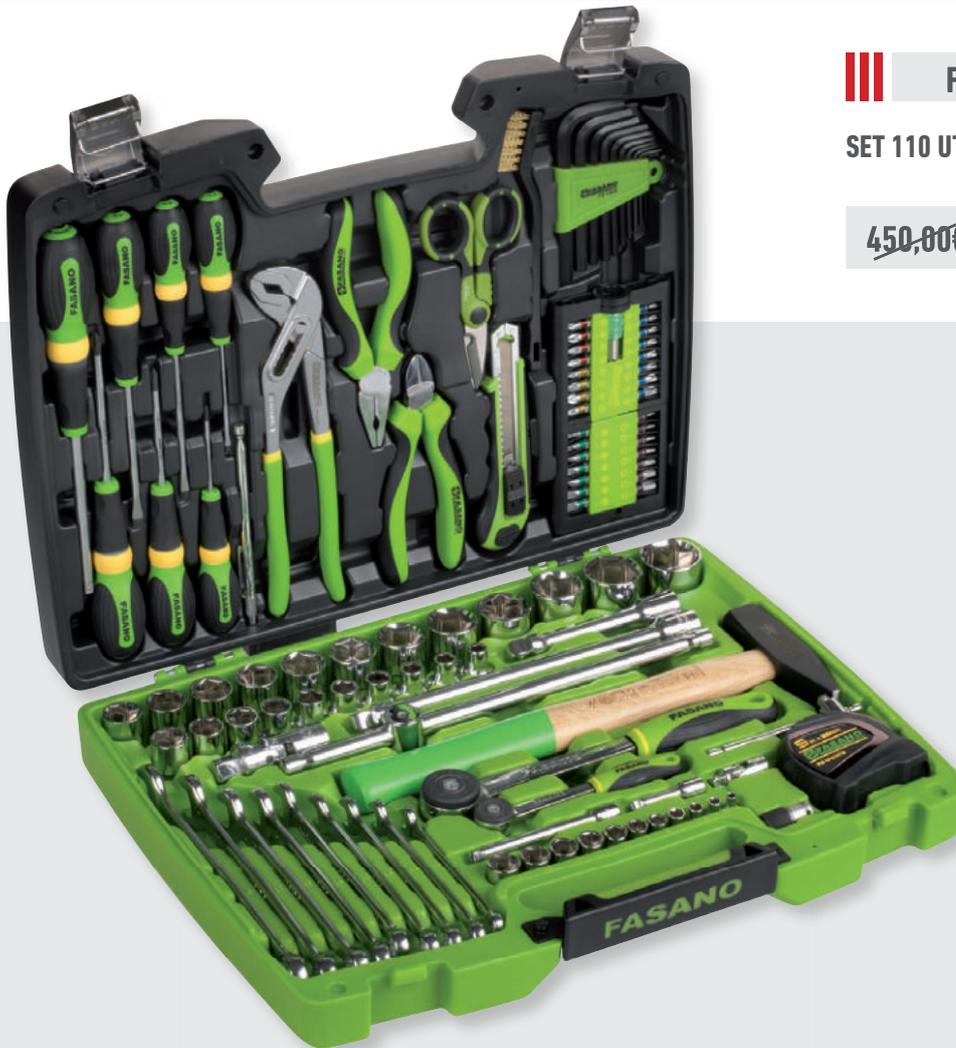

FG 625/S110

SET 110 UTENSILI DA 1/4" 1/2"

~~450,00€~~



229,00€



FG 625/A8,9,10,11,12,13,14,15,16,17,
18,19,20,21,22,23,24,25,26,27,30,32



FG 624/E4,5,6,7,8,9,10,11,12,13,14



FG 624/CR14
FG 625/CR12



FG 625/SN12
FG 624/SN14



FG 625/ES12
FG 624/ES14



FG 624/GR14C



FG 625/PA125, 250
FG 624/PA50, 100



FG 89/38PI1 1/4"x1/4"

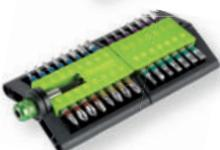

FG 85/25PH1, PH2, PH3
FG 85/25SL3, SL4, SL4.5, SL5, SL5.5, SL6, L6.5
FG 85/25PZ1, PZ2, PZ3
FG 85/H1.5, H2, 2.5, H3, H4, H5, H6
FG 85/25T9, T10, T15, T20, T25, T27, T30, T40
FG 88/60PI2



FG 139/B



FG 48/L



FG 49



FG 600/B8,10,11,12,13,14,15,17,19



FG 22/3x75, 4x100, 5.5x100
FG 22/PH0x60, PH1x80, PH2x100



FG 59SR/160
FG 63SR/160



FG 58/B240



FG 132/H500



FG 79/SP



FG 92/PM1

FG 44/MT5



CHIAVI A BUSSOLA



FG 150M/S26

SET 26 INSERTI A BUSSOLA XZN DA 1/2"

~~180,00€~~ **99,00€**



FG 150/M5 - M16



FG 150L/M5 - M16



FG 150XL/M5 - M14



FG 150XXL/M8 - M14

FG 150TX/S32

SET 32 INSERTI A BUSSOLA TORX DA 1/2"

~~190,00€~~ **109,00€**



FG 150/TX20 - TX70



FG 150L/TX20 - TX70



FG 150XL/TX40 - TX70



FG 150XXL/TX40 - TX70

FG 150H/S30

SET 30 INSERTI A BUSSOLA ESAGONALI DA 1/2"

~~200,00€~~ **119,00€**



FG 150/H5 - H19



FG 150L/H5 - H13



FG 150XL/H5 - H14



FG 150XXL/H5 - H12



3/4"

FG 629A/S15

SET BUSSOLE ESAGONALI DA 3/4" + ACCESSORI

~~550,00€~~ **299,00€**



19,22,23,27,30,32
36,41,46,50,60mm



FG 629/CR34



FG 629/SN34



FG 629/ES34



FG 629/PR200

FG 629B/S15

SET BUSSOLE POLIGONALI DA 3/4" + ACCESSORI

~~550,00€~~ **299,00€**



EXTRA-PIATTA

CHIAVE A BUSSOLA 1/2" ESAGONALE RINFORZATE



FG 628/S12

~~130,00€~~

79,00€

SET 12 CHIAVI A BUSSOLA RINFORZATE DA 1/2" SU SUPPORTO IN PLASTICA

CONTENUTO:

10, 11, 12, 13, 14, 15, 16, 17, 18, 19, 20, 21 mm



FG 628/S6

~~95,00€~~

49,00€

SET 6 CHIAVI A BUSSOLA RINFORZATE DA 1/2" SU SUPPORTO IN PLASTICA

CONTENUTO:

22, 23, 24, 27, 30, 32mm



FG 628TX/S9

~~110,00€~~

59,00€

SET 9 CHIAVI A BUSSOLA RINFORZATE DA 1/2" TORX SU SUPPORTO IN PLASTICA

CONTENUTO:

E8, E10, E12, E14, E16, E18, E20, E22, E24



FG 628L/TXS8

~~120,00€~~

69,00€

SET 8 CHIAVI A BUSSOLA RINFORZATE DA 1/2" TORX SU SUPPORTO IN PLASTICA

CONTENUTO:

E10, E12, E14, E16, E18, E20, E22, E24



FG 152RH/S9

~~120,00€~~

69,00€

SET 9 CHIAVI A BUSSOLA RINFORZATE DA 1/2" ESAGONALI SU SUPPORTO IN PLASTICA

CONTENUTO: 5-19mm



FG 152/RTXS10

~~165,00€~~

95,00€

SET 10 INSERTI A BUSSOLA RINFORZATI TORX DA 1/2"

CONTENUTO: TX20-TX70



GIRAVITI E PINZE



FG 22/S6

CONTENUTO: 3x75, 4x100, 5.5x100,
PH0x60, PH1x80, PH2x100



~~34,00€~~

19,90€



FG 22/S8

CONTENUTO: 3x75, 4x100, 5.5x100, 6.5x30
PH0x60, PH1x80, PH2x100, PH2x30



~~45,00€~~

25,90€



FG 22/S8B

CONTENUTO: 2.5x75, 3.5x100,
4x100, 6.5x150, 8x150, PH0x60,
PH1x80, PH2x150



~~50,00€~~

28,90€



FG 22/S10

CONTENUTO: 2.5x60, 3x75, 4x100,
5.5x150, 6.5x150, 4x30 PH0x60, PH1x80,
PH2x100, PH1x30



~~62,00€~~

34,90€



FG 22/S12

CONTENUTO: 2.5x60, 3x75, 4x100, 5.5x150,
6.5x150, 8x150, 4x30, PH0x60, PH1x80,
PH2x100, PH3x150, PH1x30



~~87,00€~~

48,90€



FG 22TX/S6

CONTENUTO: TX10, TX15, TX20, TX25, TX27,
TX30



~~62,00€~~

35,90€



FG 22XL/S8

SET GIRAVITI EXTRA-LUNGI PER VITI CON TESTA AD INTAGLIO E A CROCE PHILLIPS

~~92,00€~~

49,90€



FG 22TX/LS11

SET GIRAVITI EXTRA-LUNGI PER VITI CON IMPRONTA TORX

~~155,00€~~

89,90€



FG 139/B

SET 10 CHIAVI MASCHIO A L ESAGONALI - SERIE CORTA

1,5,2,2,5,3,4,5,5,5,6,8,10mm

~~15,00€~~

8,90€

FG 139/C

SET 10 CHIAVI MASCHIO A L ESAGONALI - SERIE LUNGA

1,5,2,2,5,3,4,5,6,8,10mm

~~22,00€~~

11,90€



FG 139/D

SET 10 CHIAVI MASCHIO A L ESAGONALI - SERIE CORTA

1,5,2,2,5,3,4,5,5,5,6,8,10mm

~~20,00€~~

10,90€

FG 139/E

SET 10 CHIAVI MASCHIO A L ESAGONALI - SERIE LUNGA

1,5,2,2,5,3,4,5,6,8,10mm

~~31,00€~~

17,90€



FG 139

SET 12 CHIAVI MASCHIO A L ESAGONALI - SERIE SFERICA

1,5,2,2,5,3,4,4,5,5,5,5,6,7,8,10mm

~~34,00€~~

18,90€

FG 139/L

SET 12 CHIAVI MASCHIO A L ESAGONALI - SERIE LUNGA

1,5,2,2,5,3,4,4,5,5,5,5,6,7,8,10mm

~~38,00€~~

21,90€

TESTA SFERICA



FG 139/S9

SET 9 CHIAVI MASCHIO A L ESAGONALI E LATO CORTO 110°

CONTENUTO: 1,5 - 10,0mm

~~37,00€~~

19,90€

TESTA SFERICA



GIRAVITI E PINZE



FG 138/BP

SET 9 CHIAVI MASCHIO TORX A L E TESTA SFERICA

CONTENUTO:
TX8,10,15,20,25,27,30,40,50

~~56,00€~~ **31,90€**

TESTA SFERICA



FG 138

SET 12 CHIAVI MASCHIO TORX A L

CONTENUTO:
TX7,X8, 9, 10,15,20,25,27,30,40,45, 50

~~52,00€~~ **29,90€**



FG 139/LM

SET 10 CHIAVI MASCHIO A L ESAGONALI - SERIE LUNGA

CONTENUTO: 1.5, 2, 2.5, 3, 4, 5, 6, 7, 8, 10mm

~~48,00€~~ **27,90€**

ESTREMITÀ MAGNETICA



FG 138/M

SERIE 10 CHIAVI MASCHIO A L TORX

CONTENUTO: TX9 - TX50

~~58,00€~~ **33,90€**

ESTREMITÀ MAGNETICA



FG 85TX/S11

SET 10 INSERTI TORX + PORTA INSERTI

FG 85/25T7,T8,T9,T10, T15, T20, T25, T27,T30, T40 + portainseriti

~~30,00€~~ **17,90€**



FG 85/S11

SET 10 INSERTI DA 1/4" + PORTAINSERITI

FG 85/25PH1,PH2,PH3,
FG 85/25PZ1,PZ2,PZ3
FG 85/SL4, 5, 6, 7
FG 88/60PI2

~~28,00€~~ **16,90€**



FG 85/S15L

SET 15 INSERTI DA 1/4", LUNGHEZZA 100MM

FG 85/100F3, F4, F5.5
FG 85/100PH0, PH1, PH2, PH3
FG 85/100PZ1, Pz2, PZ3
FG 85/100H4, H5, H6
FG 85/100T15, T20, T25

~~92,00€~~ **49,90€**





FG 56/S3 ~~82,00€~~ **49,90€**

SET 3 PINZE A BECCHI LUNGI ZIGRINATI

CONTENUTO: FG 56/0, FG 56/45, FG 56/90



FG 57/S3 ~~110,00€~~ **65,00€**

SET 3 PINZE A BECCHI LUNGI ZIGRINATI

CONTENUTO: FG 57/0, FG 57/45, FG 57/90



FG 59PV/S3 ~~66,00€~~ **37,90€**

SET 3 PINZE, CON MANICI IN DOPPIO STRATO DI PVC

FG 59PV/160, FG 61PV/160, FG 63PV/160



FG 66/TF220 ~~102,00€~~ **59,90€**

PINZA TORCIFILO REVERSIBILE A RITORNO AUTOMATICO

L/mm 220



FG 51/S4B ~~96,00€~~ **55,00€**

SET 4 PINZE PER ANELLI ELASTICI 19-60MM

"INSERTI RINFORZATI PER ANELLI DI GRANDE TENUTA"



FG 55/S4B ~~135,00€~~ **75,00€**

SET 4 PINZE PER ANELLI ELASTICI CON INSERTI RINFORZATI IN ACCIAIO 19-60MM



ELETTRONICA E ELETTROTECNICA

FG 22E/S6

SET 6 GIRAVITI ISOLATI

CONTENUTO: 3X100, 4X100, 5.5X125, PH0X60, PH1X80, PH2X100



~~55,00€~~ **31,90€**

FG 22E/SZ6

SET 6 GIRAVITI ISOLATI

CONTENUTO: 3x100, 4x100, 5.5x125 PZ0x60, PZ1x80, PZ2x100



~~55,00€~~ **31,90€**



FG 59IS/S3

SET 3 PINZE CON MANICI ISOLATI

~~115,00€~~ **59,90€**



FG 68/CC

TAGLIACAVI PER CAVI IN RAME - NON ISOLATO

Capacità: 255mm² - 32 Ømm

~~168,00€~~ **89,00€**



FG 68/CR

TAGLIACAVI A CRICCHETTO - NON ISOLATO

Capacità: 325mm² - 36 Ømm

~~205,00€~~ **99,00€**



FG 68/CS1

SPELLACAVI SEMPLICE

FG 68/CS1-R
Lama di ricambio: 5,70€

~~16,00€~~ **9,50€**

FG 68/CS2

SPELLACAVI CON LAMA A COLTELLO

FG 68/CS2-R
Lama di ricambio: 5,70€

~~18,00€~~ **10,90€**

FG 68/CS6

SPELLACAVI E LICOIDALE

FG 68/CS6-R
Lama di ricambio: 7,30€

~~25,50€~~ **14,90€**



FG 68/SP1

SPELLACAVI MULTIFUNZIONE

CAPACITÀ:
0,5 - 6mm² / 20-10AWG
RG59 & RG6

~~21,00€~~ **9,90€**



FG 68/SP2

SPELLAFILI FRONTALE, DOTATA DI INCAVO SPELLAFILI

~~14,50€~~ **8,50€**



FG 84F/S6 **16,90€**

SET 6 MICROGIRAVITI IN BOX DI CARTONE

CONTENUTO: 1.5, 2.0, 2.5, 3.0, 3.5, 4.0

FG 84TX/S6 **18,90€**

SET 6 MICROGIRAVITI IN BOX DI CARTONE

CONTENUTO: TX07, TX08, TX09, TX10, TX15, TX20



FG 96/DG

MULTIMETRO DIGITALE DC/AC - OHM

FUNZIONI AGGIUNTIVE:

- MISURAZIONE TEMPERATURA
- MISURAZIONE DI UMIDITÀ
- MISURAZIONE LUX
- MISURAZIONE DEL SUONO

~~185,00€~~ **99,00€**

FUNZIONE

DC	0.4 V, 4 V, 40 V, 400 V, 600V (± 0.7%)
AC	4 V, 40 V, 400 V, 600V (± 0.8%)
Ω	400 Ω, 4K Ω, 400kΩ, 4MΩ (± 1.2) 40MΩ (± 2.0%)
CAPACITA'	4nF, 40nF, 400nF, 4μF, 40 μF, 200 μF (± 3.0%)
FREQUENZA	10Hz, 100Hz, 1kHz, 10kHz, 100kHz (± 2.0%)
DUTY CYCLE	0.1% - 99.9% (± 3.0%)
TEST DI CONTINUITA'	sì/sì/yes
PROVA DIODI	sì/sì/yes
TEMPERATURA	-20°C - 400°C (± 3.0% / 0.1°C) -20°C - 1.000°C (± 3.0% / 1°C)
CAPACITA' RILEVAZIONE UMIDITÀ	30% - 95% RH ((± 5.0%)
LUX	4.000 Lux / 40.000 Lux ((± 5.0%)
CAPACITA' RILEVAZIONE SUONO	35 - 100dB ((± 4dB)
STANDBY	Dopo 15 minuti
INDICATORE LIVELLO BATTERIA	Sì
BATTERIA	9V
DIMENSIONE	8x3.5x16.5H mm



UTENSILI DINAMOMETRICI

CHIAVI DINAMOMETRICHE PER SERRAGGI DESTROSI

PRECISIONE DI SERRAGGIO: $\pm 4\%$

IMPUGNATURA ERGONOMICA IN POLIPROPILENE SOFT-TOUCH

QUADRANTE CON DOPPIA SCALA NM E LBS CON NUMERI DI FACILE LETTURA

SISTEMA DI REGOLAZIONE CONTROLLATO CON AVVICINAMENTO SOFT

SISTEMA DI INVERSIONE A GHIERA INTEGRATO SULLA TESTA

CROMATURA LUCIDA

MECCANISMO INTERNO INTERAMENTE IN ACCIAIO DOTATO DI CUSCINETTO A SFERE

MECCANISMO A 72 DENTI CON 5° DI RIPRESA



CHIAVI DINAMOMETRICHE A DISINNESTO E ATTACCO QUADRO

CODICE	RISOLUZIONE	NM	LISTINO	€/PROMO	
FG 531	0.1Nm	5-25Nm	195,00	105,00	1/4"
FG 533/2	0.25Nm	10-50Nm	220,00	125,00	3/8"
FG 536/1	0.5Nm	20-100Nm	220,00	125,00	1/2"
FG 536/2	1.0Nm	40-200Nm	240,00	129,00	1/2"
FG 536/3	2.0Nm	60-340Nm	245,00	139,00	1/2"

CHIAVI DINAMOMETRICHE DIGITALI PER NM E GRADI

1/2"

CODICE	NM	LISTINO	€/PROMO
FG 543/DG1	16.8-135	630,00	379,00
FG 543/DG2	10-200	600,00	399,00

- Doppia modalità di misurazione: PICCO e TRACCIA
- Indicatore sonoro e visivo a 12 led al raggiungimento della coppia prefissata
- Possibilità di memorizzare fino a 250 differenti serraggi grazie al software PC incluso nel kit Interfaccia PC tramite presa USB
- Possibilità di impostare fino a 9 serraggi predefiniti
- Alimentazione: 2 batterie 1.5V (incluse)



1/2"

FG 546/DG

~~310,00€~~ 189,00€

GONIOMETRO DIGITALE PER SERRAGGI IN COPPIA E ANGOLARI

PRECISIONE DI SERRAGGIO: $\pm 2\%$

- Doppia modalità di misurazione: PICCO e TRACCIA
- Indicatore sonoro e visivo a 6 led al raggiungimento della coppia prefissata
- Possibilità di memorizzare fino a 50 serraggi differenti
- Alimentazione: 2 batterie 1.5V (incluse)



FG 547/DG

~~170,00€~~ 99,00€

GONIOMETRO DIGITALE PER SERRAGGI ANGOLARI

PRECISIONE DI SERRAGGIO: $\pm 2\%$

- Indicatore sonoro e visivo a 6 led al raggiungimento della coppia prefissata
- Dotato di supporto magnetico posteriore

BARRE DINAMOMETRICHE A DISINNESTO E ATTACCO QUADRO



FORNITA IN CASSETTA DI ABS

CODICE	NM	LISTINO	€/PROMO
FG 538/1	3/4"	700,00	439,00
FG 538/2	3/4"	840,00	489,00
FG 539/1	1"	1.100,00	629,00

GRADO DI PRECISIONE: $\pm 4\%$

GIRAVITE DINAMOMETRICO A TARATURA LIBERA



CODICE	NM	L/MM.	LISTINO	€/PROMO
FG 559/1	1/4"	0.1- 1.2	200,00	119,00
FG 559/2	1/4"	1 - 6	210,00	125,00
FG 559/3	1/4"	5 - 10	215,00	129,00

PRECISIONE DI SERRAGGIO: $\pm 6\%$



UTENSILI DA TAGLIO



FG 70/S110

~~325,00€~~

189,00€

**SET MASCHI E FILIERE IN ACCIAIO
AL CROMO + ACCESSORI - 110PZ**
PASSO GROSSO E FINE - FILETTATURA METRICA

						ACCESSORI
2x.04	6x0.75	12x1	2x0.4	6x0.75	12x1	GF25x9
3x0.5	7x0.75	12x1.25	3x0.5	7x0.75	12x1.25	GF8x14
4x0.7	8x0.75	12x1.5	4x0.7	8x0.75	12x1.5	GMM1.5
5x0.8	8x1	14x1	5x0.8	8x1	14x1	GMM3
6x1	9x0.75	14x1.25	6x1	9x0.75	14x1.25	GMC1
7x1	9x1	14x1.5	7x1	9x1	14x1.5	
8x1.25	10x0.75	16x1	8x1.25	10x0.75	16x1	
9x1.25	10x1	16x1.5	9x1.25	10x1	16x1.5	
10x1.5	10x1.25	18x1.5	10x1.5	10x1.25	18x1.5	
11x1.5	11x0.75		11x1.5	11x0.75		
12x1.75	11x1		12x1.75	11x1		
14x2	11x1.25		14x2	11x1.25		
16x2	12x0.75		16x2	12x0.75		



FG 75TIN/S25

**SET 25 PUNTE ELICOIDALI CILINDRICHE
IN ACCIAIO HSS -TIN 5% RETTIFICATE**
1 - 13 X0,5MM

~~185,00€~~

109,00€



FG 75CO/S25

**SET 25 PUNTE ELICOIDALI CILINDRICHE IN
ACCIAIO HSS-COBALTO 5% RETTIFICATE**
1 - 13 X0,5MM

~~230,00€~~

129,00€



FG 81HSS/S3

**SET 3 FRESE CONICHE
A GRADINO IN ACCIAIO HSS**
4-12, 4-20, 4-30MM

~~230,00€~~

139,00€



CESOIA MULTIUSO CON LAME IN ACCIAIO INOX LARGHE DIRITTE - MOD. PESANTE

HRC: 58-61

CODICE	L/MM	ACCIAIO	INOX	LISTINO	€/PROMO
FG 49/HE200	200	0.53 mm	0.36 mm	21,00	12,50
FG 49/HE250	250	0.78 mm	0.46 mm	24,00	14,50
FG 49/HE300	300	0.94 mm	0.78 mm	31,00	18,50
FG 49/HE350	350	1.24 mm	0.78 mm	39,00	23,50



TRONCABULLONI

CODICE	L/MM-"	CAPACITA'	LISTINO	€/PROMO
FG 67/350	350 - 14"	3-10mm	48,00	28,90
FG 67/450	450 - 18"	5-16mm	61,00	36,90
FG 67/600	600 24"	8-22mm	82,50	49,90
FG 67/750	750 - 30"	9-25mm	107,00	63,90
FG 67/900	900 - 36"	10-26mm	135,00	79,90

FG 49/TC

~~37,00€~~

21,90€

FORBICE DA ELETTRICISTA, DOTATA DI INCAVO SPELLAFILI E CORPO INTEGRALMENTE IN ACCIAIO

L/MM 140 - A/MM 65MM

- LAMA MICRODENTATA IN ACCIAIO
- HRC: 56
- STRUTTURA INTEGRALE IN ACCIAIO INOX
- TAGLIACAVI 12MM
- CON SUPPORTO PER CINTURA



STRUTTURA INTERAMENTE IN ACCIAIO FORGIATO



FG 49/TCX

~~46,00€~~

27,90€

FORBICE DA ELETTRICISTA, DOTATA DI INCAVO SPELLAFILI E CORPO INTEGRALMENTE IN ACCIAIO

L/MM 160 - A/MM 50MM

- LAMA MICRODENTATA IN ACCIAIO
- HRC: 56
- STRUTTURA INTEGRALE IN ACCIAIO INOX
- TAGLIACAVI 15MM
- CON SUPPORTO PER CINTURA



STRUTTURA INTERAMENTE IN ACCIAIO FORGIATO



FG 49/L

~~16,00€~~

9,50€

FORBICE MULTIUSO A LAME LUNGHE IN ACCIAIO INOX

L/MM 200 - A/MM 87MM

APERTURA MAX 151MM

HRC: 52-54

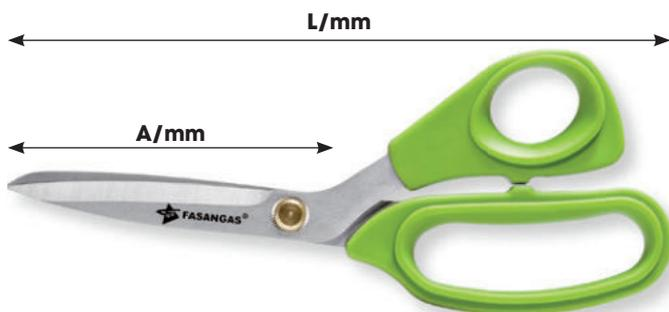

FG 50/ME

~~38,00€~~

22,90€

ARCHETTO ERGONOMICO DOTATO DI LAMA HSS BI-METAL

L/MM 402

LAMA 300MM



- LAMA POSIZIONABILE A 0° E 40°



MANUTENZIONE GENERALE



FLESSOMETRO CON CASSA IN ABS ANTI-SHOCK E NASTRO IN ACCIAIO RIVESTITO IN NYLON CLASSE II

CODICE	L/MM	BANDA	LISTINO	€/PROMO
FG 44/MT3	3	16MM	10,20	5,90
FG 44/MT5	5	25MM	16,00	9,50
FG 44/MT8	8	25MM	22,50	13,50
FG 44/MT10	10	25MM	27,00	15,90



FLESSOMETRO CON CASSA IN ABS E NASTRO IN ACCIAIO RIVESTITO IN NYLON CLASSE II

CODICE	L/MT	BANDA	LISTINO	€/PROMO
FG 43/MT3	3	16MM	6,30	3,80
FG 43/MT5	5	29MM	8,50	4,80

FG 95/CA

CALIBRO A CORSOIO, LETTURA CINQUANTESIMALE
- L/MM: 150



~~48,00€~~

26,90€

FG 95/DG

CALIBRO A CORSOIO, DIGITALE
- L/MM: 150



~~86,00€~~

49,90€



MICROMETRI CENTESIMALI PER ESTERNI

- CONTATTI IN METALLO DURO
- STELO Ø 6.5MM
- ARCO CROMATO

CODICE	Ø/MM	RISOLUZIONE	LISTINO	€/PROMO
FG 95/M1	0-25	0,01	49,00	29,90
FG 95/M2	25-50	0,01	56,00	32,90
FG 95/M3	50-75	0,01	66,00	39,90
FG 95/M4	75-100	0,01	75,00	44,90

FG 127/S1

SET SCALPELLI E PUNZONI

~~45,00€~~

25,90€



FG 128C/S6

SET 6 CACCIASPINE
- MISURE: 2,3,4,5,6,8MM

~~40,50€~~

24,50€



FG 712/L4

PORTA MINUTERIE A RIPIANI GIREVOLI

- FORNITO CON DIVISORI INTERNI
- DOTATO DI 4 RIPIANI GIREVOLI E VASCHETTA SUPERIORE PORTA MINUTERIE
- MATERIALE: ABS RESISTENTE AGLI URTI
- DOTATO DI 4 PIEDI D'APPOGGIO

~~140,00€~~

79,00€



FG 92/PM4

~~27,50€~~

12,90€

PROLUNGA MAGNETICA
TELESCOPICA (165-622MM)



FG 92/PF

~~27,50€~~

12,90€

PROLUNGA MAGNETICA
CON ASTA FLESSIBILE

LUNGHEZZA
ASTA: 400MM



FG 92/GR

PROLUNGA MAGNETICA FLESSIBILE
- CAPACITÀ 1KG / - LUNGHEZZA: 700MM

CON GRIFFE PRENSILI



~~26,50€~~

14,90€

FG 92/PM

PROLUNGA MAGNETICA
CON ASTA FLESSIBILE

ASTA
DA 1 METRO



~~19,00€~~

10,90€



MANUTENZIONE GENERALE

CE



FG 98/GAS

SALDATORE PORTATILE A GAS

- TEMPERATURA MAX: 210-450°C
- 25 WATT
- AUTONOMIA: 120 MIN CONTINUATIVI
- FORNITO CON PUNTE PER SALDARE, TAGLIARE E SOFFIARE

~~115,00€~~ 69,00€

CE



FG 98/LT

SALDATORE PORTATILE CON BATTERIA AL LITIO

- TEMPERATURA MAX: 600°C
- AUTONOMIA: 40MIN CONTINUATIVI
- TEMPO DI RICARICA: 3.5H
- FORNITO CON PUNTE PER SALDARE, TAGLIARE E SOFFIARE

~~275,00€~~ 149,00€

FG 98/ST8

MINI SALDATORE CON ATTACCO USB

- MAX TEMPERATURA: 480 °C

~~35,00€~~ 19,90€



CE

FG 98/PC8

MINI CUTTER PER PLASTICA CON ATTACCO USB

- MAX TEMPERATURA: 400 °C

~~35,00€~~ 19,90€



CE

FG 98/SS36

SALDATORE A STILO A DOPPIA POTENZA

- CLASSE DI PROTEZIONE: I

CE



~~62,00€~~ 36,90€

- PUNTA DI RICAMBIO (FG 96/TIP2): 6,00 EURO

FG 494/S12

PISTOLA PER COLLA A CALDO
- KIT COMPLETO DI 12 STICK
DI COLLA TERMOFUSIBILE

~~55,00€~~ **32,90€**



- POTENZA NOMINALE DI RISCALDAMENTO: 80W
- TEMPERATURA DI ESERCIZIO: 193°C (383°F)
- TEMPO DI RISCALDAMENTO: 3/5 MIN
- LUNGHEZZA STICK COLLA: 200MM
- DIAMETRO STICK COLLA: 11.5MM



FG 494/A180

**PISTOLA PROFESSIONALE
PER COLLA A CALDO**

~~145,00€~~ **89,00€**



- POTENZA NOMINALE DI RISCALDAMENTO: 180W
- TEMPERATURA DI ESERCIZIO: 193°C (383°F)
- TEMPO DI RISCALDAMENTO: 3/5 MIN
- LUNGHEZZA STICK COLLA: 100,250,350MM
- DIAMETRO STICK COLLA: 11/11.5MM



FG 93/P

**SPECCHIETTO RIGIDO
IN MATERIALE PLASTICO**

~~3,50€~~ **1,90€**



FG 93/M95

**SPECCHIETTO TELESCOPICO
E ARTICOLATO IN ACCIAIO**

~~30,00€~~ **17,90€**

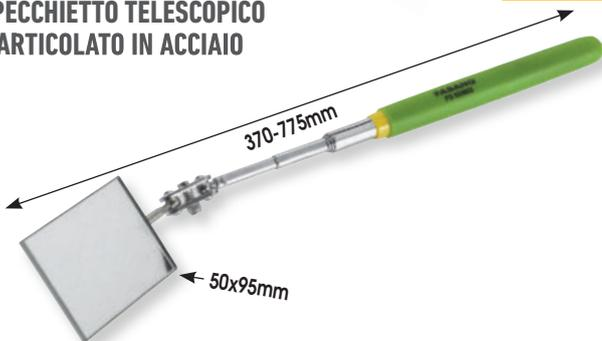

FG 47/S3

**SET 3 RASCHIETTI A BATTERE
CON LAMA IN ACCIAIO INOX**

~~58,00€~~ **33,90€**



FG 47/S4

**SET 4 SPATOLE
IN ACCIAIO INOX**

~~21,50€~~ **12,90€**



FG 125/S3

SET 3 LEVE

~~65,00€~~ **39,00€**



FG 491

SIRINGA PER OLIO
- CAPACITÀ: 500CC
- L/MM TUBO: 260

~~18,50€~~ **10,90€**



LAMPADE

FG 204
MINI LAMPADA PORTATILE A LED
BATTERIA AL LITIO LUNGA DURATA

~~30,80€~~ **17,90€**

- 300 lumen
- Li-Ion battery
- 12.5h
- Max 3 h

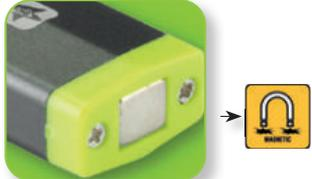

DOTATA DI SISTEMA
MAGNETICO



300
LUMEN DI
POTENZA

FG 206
LAMPADA RICARICABILE A LED

~~55,80€~~ **27,90€**

CE

- 360 LUMEN
- LI-ION BATTERY
- IPX4
- MAX 3 H



NEW



**COMPATTA, TASCABILE, POTENTE
PORTALA SEMPRE CON TE!**

EXTRA-PIATTA



**ULTRA SOTTILE, SNODATA
E DOTATA DI LED SUPERIORE**

ORIENTABILE A 360°

FG 207
LAMPADA RICARICABILE A LED

~~65,00€~~ **32,90€**



- 300 LUMEN
- IP54
- LI-ION BATTERY
- MAX 6 H

FG 210/A
MINI FARETTO PORTATILE A LED

~~90,00€~~

49,90€

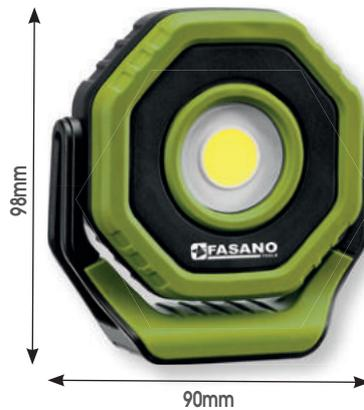

- 700 LUMEN
- LI-ION BATTERY
- MAGNETIC
- MAX 10H
- IP65



FG 208
LAMPADA SOTTO COFANO
RICARICABILE A LED

~~260,00€~~

139,00€

LUNGHEZZA REGOLABILE:
1.300-2.060MM

LAMPADA PORTATILE
INTEGRATA E REMOVIBILE

DOTATA DI SISTEMA
MAGNETICO



- IPX4
- MAX 8 H
- LI-ION BATTERY
- 1.200 LUMEN





LAMPADE



**LUMINOSITA' REGOLABILE
E DOTATA DI LED SUPERIORE**



ORIENTABILE A 360°

FG 211

~~110,00€~~

59,00€

LAMPADA RICARICABILE A LED



CE

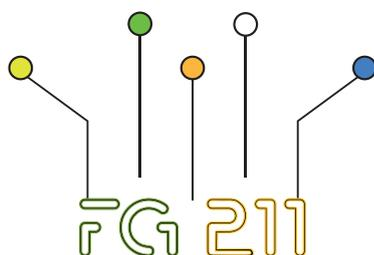

TOP LED DI PUNTAMENTO



ORIENTABILITÀ A 360°



REGOLATORE D'INTENSITÀ



INDICATORE DI CARICA



BASE MAGNETICA E GANCIO ESTRAIBILE

FG 212

~~78,00€~~

39,00€

LAMPADA RICARICABILE A LED



174mm



200 LUMEN



120 LUMEN

CE



IP20



MAGNETIC



MAX 5H



LI-ION BATTERY

FG 213/L480 ~~65,00€~~ **39,00€**

LAMPADA DA TESTA A DOPPIO LED CON
SENSORE ON/OFF CONTACTLESS



- 480 lumen
- 2.5h
- Max 10 h



SENSORE ON/OFF
CONTACTLESS



4 LIVELLI DI
INCLINAZIONE



DOTATA DI 4 MAGNETI POSTERIORI
PER L'UTILIZZO SENZA BANDA ELASTICA

NEW

FG 214/L600 ~~85,00€~~ **49,00€**

TORCIA RICARICABILE A LED



- 600 lumen
- 4h
- Max 15 h



CONO LUMINOSO
REGOLABILE



PIASTRA DI SUPPORTO
A PARETE IN DOTAZIONE

NEW



CON UN SEMPLICE GESTO
DAI LUCE AL TUO LAVORO!

600 LUMEN DURATA MAX 15H

LA VERSATILITA' CONTA

Con il Sistema portautensili Fasano Tools componibile ed impilabile, disponi i portautensili assecondando le tue necessità. Adatto per ogni utilizzo, il nostro Kit di 4 valigie in ABS consente di lavorare in velocità, perché trovi tutto ciò di cui hai bisogno esattamente dove dovrebbe essere!



MANIGLIONE
A SCOMPARSA
PER FACILITARNE
IL TRASPORTO



PREDISPOSIZIONE
PER LUCCHETTO
DI CHIUSURA



SISTEMA
DI CHIUSURA
RINFORZATO



PORTA ETICHETTE



ORGANIZER VERSATILE

Il sistema di valigie portautensili Fasano Tools, presenta un design versatile. Predisponi come desideri la minuteria, gli accessori ed i piccoli utensili all'interno delle cassetture!

SISTEMA DI
BLOCCAGGIO
ANTERIORE



PORTATILE

COMPONIBILE

SICURA E DUREVOLE



NEW



FG 1425 ~~102,00€~~ **54,00€**

VALIGIA PORTAUTENSILI IN ABS
DIMENSIONE: 456X372X115MM
PESO: 2.1KG

NEW



FG 1426 ~~120,00€~~ **64,00€**

VALIGIA PORTAUTENSILI IN ABS
DIMENSIONE: 456X372X155MM
PESO: 2.4KG

NEW



FG 1427 ~~170,00€~~ **90,00€**

VALIGIA PORTAUTENSILI IN ABS
DIMENSIONE: 456X372X262MM
PESO: 3KG



FG 1434

VALIGIA PORTAUTENSILI IN ABS
DOTATA DI BOX INTERNI
DIMENSIONE: 456X372X115MM
PESO: 3.2KG

~~145,00€~~ **76,50€**

NEW

FG 1438/S4 ~~630,00€~~ **335,00€**

KIT 4 VALIGIE IN ABS IMPILABILI
CON BASE D'APPOGGIO

PESO: 12KG - PORTATA: 100KG

NEW



FG 1425 2pz

FG 1426

FG 1427

FG 1438/S4B ~~680,00€~~ **359,00€**

KIT 4 VALIGIE IN ABS IMPILABILI
CON BASE D'APPOGGIO DI CUI UNA DOTATA DI BOX INTERNI

PESO: 13.1KG - PORTATA: 100KG

NEW



FG 1434

FG 1425

FG 1426

FG 1427



BORSE DA LAVORO

FG 114/L2

~~82,50€~~

34,90€

VALIGIA PORTA UTENSILI IN ABS

- 2 SCOMPARTI SOVRAPPONIBILI E SEPARABILI
- FINESTRE ANTERIORI TRASPARENTI
- MANIGLIA ERGONOMICA ORIENTABILE E REGOLABILE

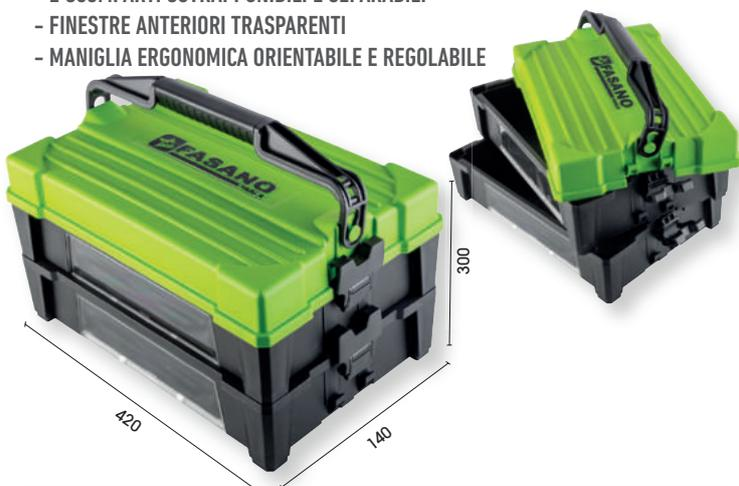

FG 1440

~~60,00€~~

29,90€

BOX PORTAMINUTERIE DOTATO DI 12 CONTENITORI ASPORTABILI



FG 1445



BOX PORTAMINUTERIE DOTATO DI 8 CONTENITORI ASPORTABILI E DIVISORI REGOLABILI

DIMENSIONE: 385X320X60MM

~~45,00€~~

26,90€



FG/XTV

~~80,00€~~

34,90€

BORSA PORTA-UTENSILI CON SISTEMA DI SEDUTA

- COMODO SISTEMA DI SEDUTA
- STRUTTURA IN ACCIAIO RINFORZATA E RICHIUDIBILE
- GOMMINI DI APPOGGIO ANTI-GRAFFIO



FG 111/A

~~56,00€~~

31,90€

CASSETTA PORTA-UTENSILI A 3 SCOMPARTI

- PREDISPOSIZIONE PER LUCCHETTO
- DIVISORIO SCOMPARTO SUPERIORE
- STRUTTURA IN LAMIERA



CASSETTA PORTA-UTENSILI A 5 SCOMPARTI

- PREDISPOSIZIONE PER LUCCHETTO
- DIVISORIO SCOMPARTO SUPERIORE
- STRUTTURA IN LAMIERA



CODICE	DIMENSIONE	LISTINO	€/PROMO
FG 111/B	430x200x200mm	68,00	37,90
FG 111/C	530x200x200mm	82,00	42,90

FG 111/AS55

~~650,00€~~

219,00€

CASSETTA PORTA-UTENSILI FG 111/C CON 5 SCOMPARTI CON ASSORTIMENTO 55 UTENSILI



FG 111/AS104

~~800,00€~~

299,00€

CASSETTA PORTA-UTENSILI FG 111/C CON 5 SCOMPARTI CON ASSORTIMENTO 104 UTENSILI



PER IL CONTENUTO CONSULTARE PAGINA 269 DEL CATALOGO GENERALE



PER IL CONTENUTO CONSULTARE PAGINA 269 DEL CATALOGO GENERALE



BORSE DA LAVORO



FG 115/A

~~240,00€~~



128,00€

VALIGIA PORTA-UTENSILI IN POLIPROPILENE - MOD. BASIC

- SERRATURA CENTRALE CON CHIAVE
- SISTEMA PORTA UTENSILI AD ELASTICO
- DOTATA DI PIEDI DI APPOGGIO
- FONDO TERMOFORMATO PORTA OGGETTI
- 2 BOX IN PLASTICA PER MINUTERIA

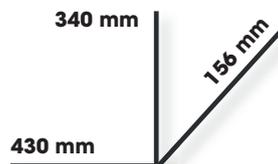

FG 117/A

~~395,00€~~



209,00€

VALIGIA PORTA-UTENSILI IN ABS TERMOFORMATO

- 2 SERRATURE LATERALI CON CHIAVE
- SISTEMA PORTA UTENSILI A TASCHE
- DOTATA DI PIEDI DDI APPOGGIO
- FONDO TERMOFORMATO
- SISTEMA TROLLEY INTEGRATO

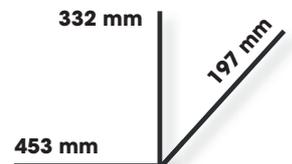

FG 118/AS56

~~721,20€~~

379,00€

ASSORTIMENTO 56 UTENSILI PER ELETTROTECNICA



FG 22E/2.5x75	GIRAVITE ISOLATO A TAGLIO 2.5x75 mm
FG 22E/3x100	GIRAVITE ISOLATO A TAGLIO 3x100 mm
FG 22E/4x100	GIRAVITE ISOLATO A TAGLIO 4x100 mm
FG 22E/5.5x125	GIRAVITE ISOLATO A TAGLIO 5.5x125 mm
FG 22E/6.5x150	GIRAVITE ISOLATO A TAGLIO 6.5x150 mm
FG 22E/PH0x60	GIRAVITE ISOLATO A CROCE PH0x60
FG 22E/PH1x80	GIRAVITE ISOLATO A CROCE PH1x80
FG 22E/PH2x100	GIRAVITE ISOLATO A CROCE PH2x100
FG 129/C4	CACCIASPINA 4mm
FG 129/C5	CACCIASPINA 5mm
FG 126/SL1	SCALPELLO LUNGO PER ELETTRICISTI
FG 126/SL2	SCALPELLO LUNGO PER ELETTRICISTI
FG 127/P1	SCALPELLO PIATTO mm26x240L
FG 602/SP9	SET 9 CHIAVI A DOPPIA FORCHETTA 6x7-21x23mm
FG 139/C	SET 10 CHIAVI MASCHIO A L ESAGONALE LUNGO
FG 96/SS36	SALDATORE A STILO 30/60W
FG 22/FX5	GIRAVITE A BUSSOLA 5mm
FG 22/FX6	GIRAVITE A BUSSOLA 6mm
FG 22/FX7	GIRAVITE A BUSSOLA 7mm
FG 22/FX8	GIRAVITE A BUSSOLA 8mm
FG 22/FX10	GIRAVITE A BUSSOLA 10mm
FG 22/FX13	GIRAVITE A BUSSOLA 13mm
FG 58/IS250	PINZA ISOLATA REGOLABILE A CERNIERA
FG 59/IS180	PINZA UNIVERSALE ISOLATA - 180mm
FG 61/IS200	PINZA ISOLATA BECCHI MEZZOTONDI -200mm
FG 63/IS160	TRONCHESE DIAGONALE ISOLATA -160mm
FG 68IS/160	PINZA SPELLAFILI ISOLATA -160mm
FG 49	FORBICE PER ELETTRICISTA
FG 48/IS	CUTTER ISOLATO PER ELETTRICISTI
FG 68/S1	PINZA X CAPICORDA NON-ISOLATI
FG 22/CF250	GIRAVITE CERCAFASE 110-250V
FG 68/CS2	SPELLAFILI 8-28mm
FG 48/L	CUTTER PROFESSIONALE A LAMA LUNGA
FG 136/L35	MAZZUOLA ANTI-RIMBALZO -35gr
FG 132/300	MARTELLO TEDESCO CON MANICO IN RESINA -300gr
FG 81/PT2	PUNTE A TRACCIARE
FG 44/MT5	FLESSOMETRO IN NYLON 5Mx25mm
FG 50/MS	MINISEGHETTO CON LAMA
FG 497/OP2	OLIATORE A PRESSIONE CANNUCCIA OTTONE 80cc

FG 118/AS75

~~542,40€~~

299,00€

ASSORTIMENTO 75 UTENSILI PER MANUTENZIONE GENERALE



FG 602/SP9	SET 9 CHIAVI A DOPPIA FORCHETTA 6x7-21x23mm
FG 22/2.5x75	GIRAVITE A TAGLIO 2.5x75mm
FG 22/3.5x100	GIRAVITE A TAGLIO 3.5x100mm
FG 22/4x150	GIRAVITE A TAGLIO 4x150mm
FG 22/6.5x150	GIRAVITE A TAGLIO 6.5x150mm
FG 22/8x150	GIRAVITE A TAGLIO 8x150mm
FG 22/PH0x60	GIRAVITE A CROCE PH0x60
FG 22/PH1x80	GIRAVITE A CROCE PH1x80
FG 22/PH2x150	GIRAVITE A CROCE PH2x150
FG 58/B240	PINZA REGOLABILE CERNIERA 240mm
FG 59SR/180	PINZA UNIVERSALE -180mm
FG 61SR/160	PINZA BECCHI MEZZOTONDI -160mm
FG 63SR/160	TRONCHESE TAGLIENTI DIAGONALI -160mm
FG 49/HE250	FORBICE MULTIUSO MOD. PESANTE 250mm
FG 69/CJ250	PINZA AUTOBLOCCANTE 250mm
FG 35/B4	CHIAVE A RULLINO mm250
FG 132/500	MARTELLO TEDESCO CON MANICO IN RESINA -500gr
FG 49	FORBICE PER ELETTRICISTA
FG 44/MT5	FLESSOMETRO IN NYLON 5Mx25mm
FG 80/8AP	LIMA PIATTA TAGLIO MEZZODOLCE 200mm
FG 81/MS	MATITA X FALEGNAME
FG 48/L	CUTTER PROFESSIONALE A LAMA LUNGA
FG 79/SP3	SPAZZOLA FILI RIGIDI IN ACCIAIO
FG 139/C	SET 10 CHIAVI MASCHIO A L ESAGONALE LUNGO
FG 85/S31	SET 31 INSERTI + ADATTATORE PORTA INSERTI
FG 94/300	LIVELLA MAGNETICA 300mm
FG 88/P14	GIRAVITE PORTA INSERTI 1/4"
FG 80/8AQ	LIMA QUADRA TAGLIO MEZZODOLCE 200mm

Il lavoro on the road

Arredamento furgoni!

Ai nostri clienti offriamo il massimo della qualità e dell'efficienza anche su strada. L'allestimento **Fasano Tools** per furgoni e veicoli commerciali offre la possibilità di creare l'ambiente di lavoro ideale per le proprie esigenze.

Totalmente personalizzabile e modulare, si compone di cassettiere, armadietti, mensole, scaffali e pareti provviste di griglie portautensili, porta minuterie e una vasta gamma di accessori.

Tutto il necessario per lavorare al di fuori della propria officina, seppur portandola sempre con sé.

L'arredo tecnico Fasano Tools dedicato ai veicoli attrezzati si adegua perfettamente ad ogni necessità del lavoro quotidiano. Scegli il colore e la composizione ideale!

MADE IN ITALY

Nuovi moduli in 3 varianti colore

RAL 6018

RAL 5002

RAL 3001

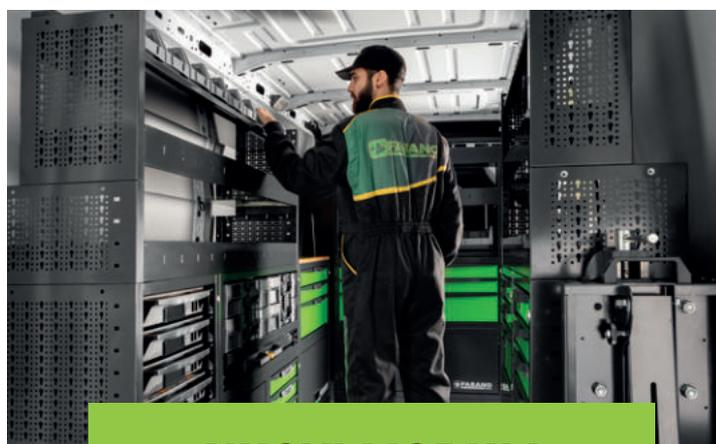

NUOVI MODULI

ARREDAMENTO FURGONI



MANIGLIE IN ABS
CON IMPUGNATURA
ERGONOMICA



CASSETTI CON
APERTURA COMPLETA
PER MODULI
PORTA UTENSILI



VALIGIE COMPONENTI
CON SCOMPARTI
PORTA MINUTERIE



ANTE ESTRAIBILI
AD APERTURA
TOTALE



VASCHEE IN PLASTICA
PORTA MINUTERIE

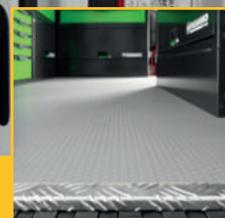

PIANALI
ANTISCIVOLO

LA SOLUZIONE MODULARE PER COMPORRE
L'ARREDAMENTO DEL TUO FURGONE

in 3 facili STEP



1° STEP BASE

SELEZIONARE LA BASE:

- APERTA (SE POSIZIONATA SUL PASSARUOTA) OPPURE CHIUSA
- EVENTUALE RIALZO

2° STEP CASSETTI

SELEZIONARE LA CASSETTIERA

(LA TIPOLOGIA ED IL NUMERO DELLE CASSETTIERE VARIANO IN FUNZIONE DELLA LARGHEZZA DELLA BASE)

3° STEP RIPIANI

AGGIUNGERE EVENTUALI RIPIANI

CON I RELATIVI MONTANTI LATERALI
(TENERE PRESENTE LA PROFONDITA' DELLA STRUTTURA E LA SAGOMA DEL FURGONE)





ARREDAMENTO FURGONI

NEW



FG 119V/C03

~~2.192,00€~~

1.149,00€

CONFIGURAZIONE ARREDAMENTO
TECNICO PER FURGONI

Dimensioni: 735x400x1.360mm

Peso: 46,4 Kg



FG 119B/C03



FG 119R/C03

NEW



FG 119V/C014

~~3.265,00€~~

1.699,00€

CONFIGURAZIONE ARREDAMENTO
TECNICO PER FURGONI

Dimensioni: 980x400x1.360mm

Peso: 66,6 kg



FG 119B/C014



FG 119R/C014

NEW



FG 119V/C023

~~3.940,00€~~

1.999,00€

CONFIGURAZIONE ARREDAMENTO
TECNICO PER FURGONI

Dimensioni: 1.225x400x1.360mm

Peso: 81,8 kg



FG 119B/C023



FG 119R/C023

NEW



FG 119V/C011

~~3.624,00€~~

1.899,00€

**CONFIGURAZIONE ARREDAMENTO
TECNICO PER FURGONI**

Dimensioni: 980x400x1.592mm

Peso: 75,6 Kg



FG 119B/C011



FG 119R/C011

NEW



FG 119V/C021

~~4.330,00€~~

2.299,00€

**CONFIGURAZIONE ARREDAMENTO
TECNICO PER FURGONI**

Dimensioni: 1.225x400x1.592mm

Peso: 92,4Kg



FG 119B/C021



FG 119R/C021

NEW



FG 119V/C031

~~5.635,00€~~

2.999,00€

**CONFIGURAZIONE ARREDAMENTO
TECNICO PER FURGONI**

Dimensioni: 1.470x400x1.592mm

Peso: 162,2 Kg



FG 119B/C031



FG 119R/C031



ESTRATTORI



FG 162/S3

~~340,00€~~

199,00€

SET 3 ESTRATTORI A 2 GRIFFE
- 27-90MM, 27-135MM, 35-155MM



FG 163/S2B

ESTRATTORE A 3 GRIFFE PER PRESA
ESTERNA + GRIFFE PER PRESA INTERNA
- APERTURA MAX PER PRESA ESTERNA: 7-140MM
- APERTURA MAX PER PRESA INTERNA: 50-70MM

~~255,00€~~

139,00€

ESTRATTORE A 2 GRIFFE SOTTILI

- PRESA INTERNA ED ESTERNA
- GRIFFE INTERCambiabili SUPER SOTTILI IN ACCIAIO CROMO VANADIO
- SPESSORE GRIFFA: 2MM
- VITE IN ACCIAIO CROMO VANADIO

CODICE	A/MM	B/MM	C/MM	LISTINO	€/PROMO
FG 168/EF1	110	140	186	298,00	179,00
FG 168/EF2	195	140	186	310,00	189,00

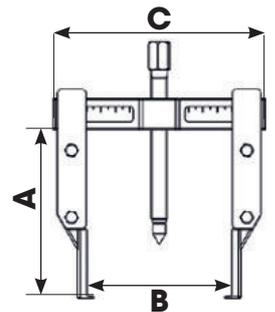
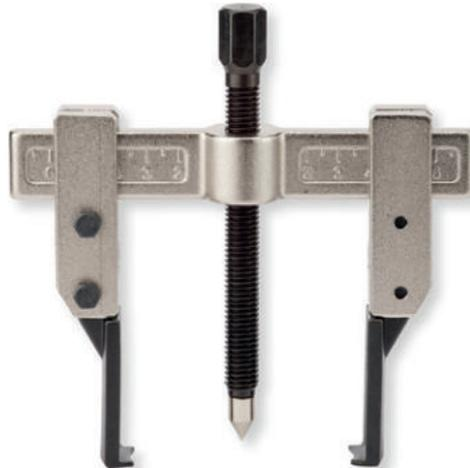

FG 165/...

ESTRATTORE AUTOCENTRANTE A 3 GRIFFE

- POSSIBILITÀ DI 4 POSIZIONI DIFFERENTI
- PRESA ESTERNA
- MECCANISMO AUTOCENTRANTE
- GRIFFE CON APERTURA PER CONSENTIRE UNA MIGLIOR PRESA SU BULLONI SPECIALI

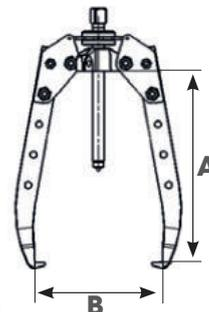

CODICE	A/MM	B/MM	LISTINO	€/PROMO
FG 165/1	120	125	275,00	165,00
FG 165/2	210	220	350,00	199,00
FG 165/3	270	280	520,00	309,00

FG 162/ME

~~30,00€~~

17,90€

ESTRATTORE A 2 GRIFFE OSCILLANTI

- GRIFFE IN ACCIAIO CROMO VANADIO
- VITE IN ACCIAIO CROMO VANADIO

A/MM 60MM - H/MM 85MM

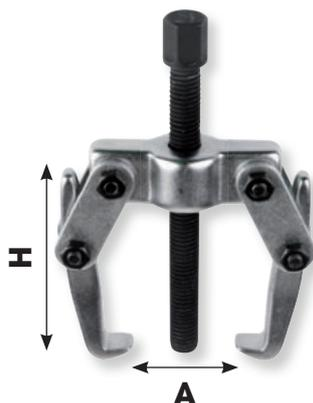

ESTRATTORE UNIVERSALE A 2 GRIFFE

- PRESA ESTERNA
- GRIFFE REGOLABILI IN ACCIAIO CROMO VANADIO
- VITE IN ACCIAIO CROMO VANADIO

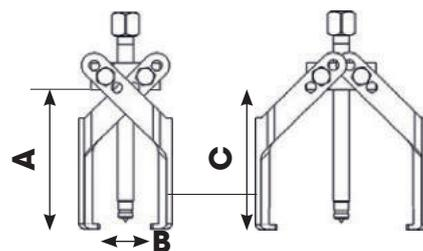

CODICE	A/MM	B/MM	C/MM	D/MM	LISTINO	€/PROMO
FG 162/FR1	90	55	90	95	145,00	89,00
FG 162/FR2	125	70	120	125	190,00	115,00
FG 162/FR3	125	80	160	125	230,00	139,00

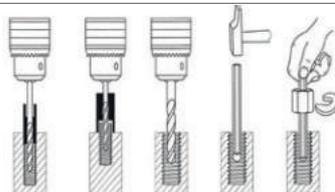

- DOTATO DI GUIDE PER INTERNO ED ESTERNO E PUNTE PER FORARE
- PER VITI/BULLONI CON DIAMETRO 6-16MM

FG 168/S25

~~135,00€~~

79,00€

SET ESTRATTORI PER VITI E PRIGIONIERI SPEZZATI

FG 182/S14

~~220,00€~~

129,00€

SET ESTRATTORI PER CUSCINETTI CON FALSE SFERE

- ØMM: 5, 6, 8, 9, 11, 12.5



UTENSILI PNEUMATICI



CE



**COPPIA
DI SPUNTO**



**MARTELLO
SINGOLO**



CE



**COPPIA
DI SPUNTO**



**MARTELLO
DOPPIO**



FGA 307 ~~250,00€~~ **145,00€**

AVVITATORE AD IMPULSI-1/2"

FGA 309 ~~300,00€~~ **169,00€**

AVVITATORE AD IMPULSI-1/2"



CE



COPPIA DI SPUNTO



MARTELLLO DOPPIO



FGA 312 ~~380,00€~~ 199,00€

AVVITATORE AD IMPULSI-1/2"



CE



MARTELLLO DOPPIO



FGA 302 ~~240,00€~~ 119,00€

AVVITATORE AD IMPULSI-1/2"



CE



Coppia di spunto



Martello singolo



FGA 307AN ~~340,00€~~ 169,00€

AVVITATORE ANGOLARE AD IMPULSI-1/2"



CE



COPPIA TORCENTE



FGA 292/B ~~215,00€~~ 119,00€

CRICCHETTO REVERSIBILE 1/2"



UTENSILI PNEUMATICI

FGA 316/L ~~830,00€~~ 469,00€

AVVITATORE AD IMPULSI - 3/4"
AD ALBERO LUNGO 6"

FGA 316 ~~760,00€~~ 419,00€

AVVITATORE AD IMPULSI-3/4"



MARTELLLO DOPPIO

CE

FGA 319/L ~~1.250,00€~~ 649,00€

AVVITATORE AD IMPULSI 1"
AD ALBERO LUNGO 6"

FGA 319 ~~1.150,00€~~ 599,00€

AVVITATORE AD IMPULSI -1"



PIN-LESS

CE

FGA 321/B ~~1.100,00€~~ 579,00€

AVVITATORE AD IMPULSI 1"
AD ALBERO LUNGO 6"

FGA 321 ~~1.050,00€~~ 559,00€

AVVITATORE AD IMPULSI -1"



MARTELLLO DOPPIO



CE



PIN-LESS

FGA 321/C

~~1.220,00€~~ **599,00€**

AVVITATORE AD IMPULSI 1" AD ALBERO LUNGO 6"

2.700 Nm	2.500 Nm
271 L/min	4.800 RPM
12.500	6:2 Bar



IDEALE PER UTILIZZI INTENSIVI



165mm



730	6:2 Bar
40 Nm	280 RPM
68 L/min	1/4" 6mm

FGA 290

~~185,00€~~ **109,00€**

CRICCHETTO REVERSIBILE 1/4"



120mm

27 Nm	240 RPM
85 L/min	1/4" 10mm
450	6:2 Bar

FGA 291/B

~~122,00€~~ **69,00€**

MINI-CRICCHETTO REVERSIBILE DA 1/4"



FGA 390

PISTOLA DI GONFIAGGIO

~~140,00€~~ **85,00€**



- OMOLOGATA CEE

- CORPO IN ALLUMINIO NICHELATO
- RIVESTIMENTO IN GOMMA ANTIOLIO
- MANOMETRO Ø80 (0-10BAR)
- PROTEZIONE SOVRAPRESSIONI
- LEVA A DUE POSIZIONI SCARICO/GONFIAGGIO
- LUNGHEZZA TUBO: 500MM



FGA 322

LEVIGATRICE PER PNEUMATICI

~~140,00€~~ **79,00€**



190mm

85 L/min	1/4" 6mm	2.600 RPM	800
		6:2 Bar	

FGA 322/R2: MOLA DI RICAMBIO 30,00€



UTENSILI PNEUMATICI

FGA 332



TRAPANO REVERSIBILE CON
MANDRINO AUTOSERRANTE 1-10MM



~~145,00€~~ 85,00€

FGA 333



TRAPANO REVERSIBILE CON
MANDRINO AUTOSERRANTE 1-13MM



~~185,00€~~ 109,00€

FGA 333/AC

~~210,00€~~ 125,00€

TRAPANO REVERSIBILE CON
MANDRINO IN ACCIAIO 1-13MM



FGA 332/AN

~~180,00€~~ 99,00€

TRAPANO ANGOLARE
MANDRINO AUTOSERRANTE
1-10MM



FGA 340

~~295,00€~~ 159,00€

- ø orbita: 5.0mm
- platorello 15 fori



FGA 340/B

~~295,00€~~ 159,00€

- ø orbita: 2.5mm
- platorello 15 fori

FGA 342/B

LEVIGATRICE
ROTO-ORBITALE

- ø orbita: 2.5mm
- platorello 3 fori



~~285,00€~~ 169,00€



FGA 337

LEVIGATRICE PNEUMATICA
PER RIMOZIONE RESIDUI GOMMOSI



~~125,00€~~ **75,00€**



FGA 330

SEGHETTO ALTERNATIVO



~~295,00€~~ **155,00€**



FGA 339/B

LEVIGATRICE ANGOLARE
- ø disco: 50mm



~~190,00€~~ **99,00€**



DISCHETTI PER FGA 339/B

CODICE	GRANA	LISTINO	€/PROMO
FGA 339/B-G60	60	9,00	5,40
FGA 339/B-G80	80	10,00	6,00
FGA 339/B-G120	120	12,00	7,20

FGA 339

LEVIGATRICE ANGOLARE
- ø disco: 115mm



~~330,00€~~ **199,00€**

FGA 335

RIVETTATRICE PNEUMATICA
- 4 testine intercambiabili



~~210,00€~~ **109,00€**

FGA 336

RIVETTATRICE PNEUMATICA
- 4 testine intercambiabili



~~550,00€~~ **329,00€**



UTENSILI PNEUMATICI

LAME ROTORE IN KEVLAR

FGA 338

SMERIGLIATRICE DIRITTA A PINZA

~~125,00€~~ 69,00€



CE

FGA 334

SMERIGLIATRICE DIRITTA A PINZA

~~145,00€~~ 82,50€



CE

FGA 338/B

SMERIGLIATRICE DIRITTA A PINZA A BASSA VELOCITA'

~~160,00€~~ 95,00€



CE

FGA 334/AN115

SMERIGLIATRICE ANGOLARE A PINZA - INCLINAZIONE 115°



~~185,00€~~ 99,00€

CE

FGA 338/AN

SMERIGLIATRICE ANGOLARE A PINZA

~~170,00€~~ 99,00€



CE

FGA 334/AN

SMERIGLIATRICE ANGOLARE A PINZA



~~185,00€~~ 109,00€

CE

FGA 338/L

SMERIGLIATRICE DIRITTA A PINZA AD ALBERO LUNGO

~~165,00€~~ 99,00€



CE

FGA 334/AL

SMERIGLIATRICE DIRITTA A PINZA AD ALBERO LUNGO

~~185,00€~~ 109,00€



CE

FGA 343/N10

LEVIGATRICE A NASTRO
- 10x330mm



~~220,00€~~ **129,00€**



CE

FGA 342

LEVIGATRICE ORBITALE
- ø orbita: 2mm



~~200,00€~~ **119,00€**



FGA 343/N20

LEVIGATRICE A NASTRO
- 20X520MM



~~270,00€~~ **162,00€**



CE

FGA 341

LEVIGATRICE MULTI-FUNZIONE

~~650,00€~~ **390,00€**



CE

~~225,00€~~ **129,00€**

FGA 382/AR15

AVVOLGITUBO AUTOMATICO
PER ARIA COMPRESSA

- ø tubo interno: 8x12mm
- Lunghezza tubo: 15metri

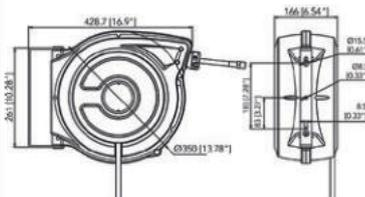

~~250,00€~~ **149,00€**

FGA 384/AR15

AVVOLGITUBO AUTOMATICO
PER ARIA COMPRESSA

- ø tubo interno: 11x16mm
- Lunghezza tubo: 15metri

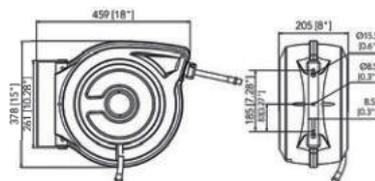

TUBO IN PVC ANTI-SCHIACCIAMENTO
STAFFA A MURO ORIENTABILE A 360°

Guida di scorrimento
automatico



Sistema di bloccaggio
a qualsiasi lunghezza



Riavvolgimento a
velocità controllata





CARRELLI E BANCHI DA LAVORO

RAL 3001

RAL 5002

RAL 6018

RAL 7021



**4 VARIANTI COLORE
PER ARREDARE I TUOI SPAZI.**



MADE IN ITALY



**SCEGLI TRA I MODELLI A DISPOSIZIONE
QUELLO PIU' ADATTO ALLE TUE NECESSITA'**



SIMPLE TOOL TROLLEY



EXTENDED TOOL TROLLEY

FG 101

CARRELLO PORTA UTENSILI MOD. FG 101

CARATTERISTICHE TECNICHE:

- Guide telescopiche con sistema di aggancio automatico
- 4 ruote in gomma vulcanizzata Ø125mm (2 fisse e 2 girevoli - 1 con freno)
- maniglione laterale in acciaio
- chiusura centralizzata
- cassetti dotati di tappetino interno in gomma



SISTEMA DI APERTURA A BAIONETTA



MANIGLIONE IN ACCIAIO



TOP IN GOMMA



PORTATA STATICA

CODICE	CASSETTI	€/LISTINO	€/PROMO
FG 101V/5G	5 CASSETTI	680,00	359,00
FG 101V/6G	6 CASSETTI	710,00	379,00
FG 101V/7G	7 CASSETTI	750,00	399,00

FG 102

CARRELLO PORTA UTENSILI MOD. FG 102

CARATTERISTICHE TECNICHE:

- Guide telescopiche con sistema di aggancio automatico
- 4 ruote in gomma vulcanizzata Ø125mm
- maniglione laterale in acciaio
- chiusura centralizzata
- cassetti dotati di tappetino interno in gomma



4 RUOTE Ø125 (2 GIREVOLI-2 FISSE)



MANIGLIONE IN ACCIAIO



TOP IN GOMMA

MADE IN ITALY



PORTATA STATICA



CODICE	Cassetti	€/Listino	€/PROMO
FG 102V/5G	5 CASSETTI	960,00	469,00
FG 102V/6G	6 CASSETTI	1.030,00	499,00
FG 102V/7G	7 CASSETTI	1.100,00	529,00
FG 102V/8G	8 CASSETTI	1.150,00	559,00

FG 102



CARRELLI E BANCHI DA LAVORO



FG 100



FG 100

CARRELLO PORTA UTENSILI MOD. FG 100

CARATTERISTICHE TECNICHE:

- Guide telescopiche con sistema di aggancio automatico
- 4 ruote in gomma vulcanizzata Ø125mm
- ripiano superiore in ABS con maniglione integrato
- chiusura laterale centralizzata
- porta flaconi laterali di serie

MADE IN ITALY



SISTEMA DI CHIUSURA LATERALE



RIPIANO SUPERIORE IN ABS



CASSETTO CON APERTURA COMPLETA



KG 800 PORTATA STATICA

CODICE			CASSETTI	€/LISTINO	€/PROMO
FG 100V/5T	FG 100B/5T	FG 100R/5T	5 CASSETTI	-1.250,00-	519,00
FG 100V/6T	FG 100B/6T	FG 100R/6T	6 CASSETTI	-1.320,00-	539,00
FG 100V/7T	FG 100B/7T	FG 100R/7T	7 CASSETTI	-1.380,00-	559,00



FG 104

CARRELLO PORTA UTENSILI MOD. FG 104

CARATTERISTICHE TECNICHE:

- Guide telescopiche con sistema di aggancio automatico
- 4 ruote in gomma vulcanizzata Ø125mm
- maniglione laterale in acciaio
- chiusura centralizzata
- cassetti dotati di tappetino interno in gomma

MADE IN ITALY



MANIGLIONE IN ACCIAIO INOX

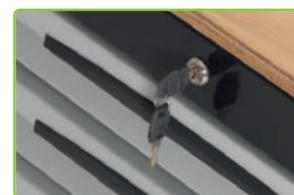

CHIUSURA CENTRALIZZATA



KG 1000 PORTATA STATICA

CODICE				CASSETTI	€/LISTINO	€/PROMO
FG 104V/6G	FG 104D/6G	FG 104B/6G	FG 104R/6G	6 CASSETTI	-1.250,00-	579,00
FG 104V/7G	FG 104D/7G	FG 104B/7G	FG 104R/7G	7 CASSETTI	-1.350,00-	599,00





FG 105

CARRELLO PORTA UTENSILI MOD. FG 105

CARATTERISTICHE TECNICHE:

- Guide telescopiche con sistema di aggancio automatico
- 4 ruote in gomma vulcanizzata Ø125mm
- maniglione laterale in acciaio
- chiusura centralizzata
- cassetti dotati di tappetino interno in gomma

MADE IN ITALY



RIPIANI INTERNI
REGOLABILI



ANTINA APRIBILE A 90°,
DOTATA DI SERRATURA



CODICE				CASSETTI	€/LISTINO	€/PROMO
FG 105V/5G	FG 105B/5G	FG 105R/5G	FG 105D/5G	5 CASSETTI	1.300,00	689,00
FG 105V/6G	FG 105B/6G	FG 105R/6G	FG 105D/6G	6 CASSETTI	1.400,00	719,00
FG 105V/7G	FG 105B/7G	FG 105R/7G	FG 105D/7G	7 CASSETTI	1.450,00	759,00



FG 109

CARRELLO PORTA UTENSILI MOD. FG 109 CON APPENDICE LATERALE

MADE IN ITALY



RIPIANI
IN GOMMA



RIPIANI INTERNI
AMOVIBILI E REGOLABILI



CODICE				CASSETTI	€/LISTINO	€/PROMO
FG 109V/6G	FG 109B/6G	FG 109R/6G	FG 109D/6G	6 CASSETTI	1.600,00	799,00
FG 109V/7G	FG 109B/7G	FG 109R/7G	FG 109D/7G	7 CASSETTI	1.650,00	849,00



CARRELLI E BANCHI DA LAVORO



FG 160

CARRELLO PORTA UTENSILI MOD. FG 160

CARATTERISTICHE TECNICHE:

- Guide telescopiche con sistema di aggancio automatico
- 4 ruote in gomma vulcanizzata Ø160mm
- maniglione laterale in acciaio
- chiusura centralizzata
- cassetti dotati di tappetino interno in gomma



- Antina apribile a 90°, dotata di serratura con chiave
- 2 ripiani interni amovibili



- 7 cassetti porta minuteria
- Profondità: 580x235mm



- Larga griglia laterale porta utensili
- Dimensioni: 665x595mm



KG 2.400 PORTATA STATICA

CODICE	CASSETTI	€/LISTINO	€/PROMO			
FG 160V/14L	FG 160B/14L	FG 160R/14L	FG 160D/14L	14 CASSETTI	-3.550,00-	1.799,00

JUMBO

MADE IN ITALY

FG 94/MS

SUPPORTO MAGNETICO PORTA UTENSILI



PVC ANTI-GRAFFIO



~~34,00€~~

15,90€

FG 94/MI

SUPPORTO MAGNETICO PORTA UTENSILI

DIMENSIONI: 120x94x400mm



KG 9

PORTATA MASSIMA



~~52,00€~~

21,90€



FG 94/R

PORTA MINUTERIE MAGNETICO

Dimensione: 165x245mm

~~20,00€~~

11,90€



FG 94/T

PORTA MINUTERIE MAGNETICO

Ø 150mm

~~17,00€~~

9,90€

NEW



FG 101V/AS136

CARRELLO PORTA UTENSILI FG 101
A 6 CASSETTI CON ASSORTIMENTO
136 UTENSILI IN MODULI RIGIDI

~~1.917,00€~~

699,00€

KG
500 **PORTATA**
STATICA

1°CASSETTO

- FG 102/03G: Modulo 14 chiavi combinate 6 - 19mm
- FG 102/17: Modulo 11 chiavi a bussola da 1/4" 4-14mm + accessori
- FG 102/21E: Modulo chiavi a bussola esagonali 1/2" 8-32mm + accessori

2°CASSETTO

- FG 102/21TX: Modulo 44 utensili con impronta Torx
- FG 102/21H: Modulo rigido inserti a bussola 1/2" esagonali e XZN
- FG 102/65B: Modulo pinza autobloccante e pinza regolabile a cerniera aperta



3°CASSETTO

- FG 102/45D: Modulo 6 giraviti taglio e croce
- FG 102/45I: Modulo 6 giraviti con impronta Torx
- FG 102/39D: Modulo 3 pinze





CARRELLI E BANCHI DA LAVORO

NEW



FG 101V/AS182

CARRELLO PORTA UTENSILI FG 101
A 7 CASSETTI CON ASSORTIMENTO
182 UTENSILI IN MODULI RIGIDI

~~1.921,00€~~



799,00€



PORTATA
STATICA

1°CASSETTO

- FG 102/03G: Modulo 14 chiavi combinate 6 - 19mm
- FG 102/17E: Modulo 65 utensili da 1/4"
- FG 102/21E: Modulo chiavi a bussola esagonali 1/2" 8-32mm + accessori

2°CASSETTO

- FG 102/39D: Modulo 3 pinze
- FG 102/45I: Modulo 6 giraviti con impronta Torx
- FG 102/45D: Modulo 6 giraviti taglio e croce



3°CASSETTO

- FG 102/48G: Modulo 52 inserti - attacco 10mm
- FG 102/VA1: Modulo porta minuterie
- FG 102/23C: Modulo 14 utensili rinforzati da 1/2"

4°CASSETTO

- FG 618/A8, A10, A13, A17, A19: Chiavi a T esagonali snodate



FG 102V/AS158

CARRELLO PORTA UTENSILI FG 102
A 6 CASSETTI CON ASSORTIMENTO
158 UTENSILI IN MODULI RIGIDI

~~2.599,00€~~ 999,00€



KG 800 PORTATA
STATICA

CODICE				€/LISTINO	€/PROMO
FG 102V/AS158	FG 102B/AS158	FG 102R/AS158	FG 102D/AS158	2.599,00	999,00

1°CASSETTO

- FG 102/03G: Modulo 14 chiavi combinate 6 - 19mm
- FG 102/21B: Modulo chiavi a bussola esagonali 1/2" 8-32mm + accessori
- FG 102/17: Modulo 11 chiavi a bussola da 1/4" 4-14mm + accessori



2°CASSETTO

- FG 102/21TX: Modulo 44 utensili TORX
- FG 102/21H: Modulo rigido inserti a bussola 1/2" esagonali e XZN
- FG 102/39D: Modulo 3 pinze con manici in pvc



3°CASSETTO

- FG 102/45F: Modulo 6 giraviti a croce phillips
- FG 102/45G: Modulo 7 giraviti ad intaglio
- FG 102/45I: Modulo 6 giraviti TORX



4°CASSETTO

- FG 102/10C: Modulo 8 chiavi a T snodate esagonali 7-19mm





CARRELLI E BANCHI DA LAVORO

NEW



FG 100V/AS192

CARRELLO PORTA UTENSILI FG 100 A 7 CASSETTI CON ASSORTIMENTO 192 UTENSILI IN MODULI RIGIDI

~~2.619,00€~~

999,00€



KG 800 PORTATA STATICA

CODICE			€/LISTINO	€/PROMO
FG 100V/AS192	FG 100B/AS192	FG 100R/AS192	2.619,00	999,00

1°CASSETTO

- FG 102/03G: Modulo 14 chiavi combinate 6 - 19mm
- FG 102/03E: Modulo rigido 8 chiavi a doppia forchetta
- FG 102/21B: Modulo chiavi a bussola esagonali 1/2" 8-32mm + accessori

2°CASSETTO

- FG 102/17E: Modulo 65 utensili da 1/4"
- FG 102/48D: Modulo 40 inserti da 1/4 + porta utensili
- FG 102/39D: Modulo 3 pinze



3°CASSETTO

- FG 102/45F: Modulo 6 giraviti a croce phillips
- FG 102/45G: Modulo 7 giraviti ad intaglio
- FG 102/45I: Modulo 6 giraviti TORX

4°CASSETTO

- FG 102/56C: Modulo utensili da percussione
- FG 102/65B: Modulo pinza autobloccante e inza regolabile a cerniera aperta
- FG 102/60C: Modulo utensili per manutenzione





FG 100V/AS229

**CARRELLO PORTA UTENSILI FG 100
A 7 CASSETTI CON ASSORTIMENTO
229 UTENSILI IN MODULI RIGIDI**

~~2.977,00€~~

1.099,00€



KG 800 **PORTATA
STATICA**

CODICE			€/LISTINO	€/PROMO
FG 100V/AS229	FG 100B/AS229	FG 100R/AS229	2.977,00	1.099,00

1°CASSETTO

- **FG 102/03G:** Modulo 14 chiavi combinate 6 - 19mm
- **FG 102/03L:** Modulo rigido 6 chiavi combinate
- **FG 102/21B:** Modulo chiavi a bussola esagonali 1/2" 8-32mm + accessori



2°CASSETTO

- **FG 102/17E:** Modulo 65 utensili da 1/4"
- **FG 102/48G:** Modulo inserti corti e lunghi con attacco 10mm
- **FG 102/21TX:** Modulo 44 utensili Torx



3°CASSETTO

- **FG 102/39D:** Modulo 3 pinze
- **FG 102/45D:** Modulo 6 giraviti a taglio e a croce
- **FG 102/45I:** Modulo 6 giraviti con impronta Torx



4°CASSETTO

- **FG 102/10C:** Modulo 8 chiavi a T snodate esagonali 7-19mm





CARRELLI E BANCHI DA LAVORO



FG 102/03G

~~135,00€~~

74,90€

MODULO RIGIDO 14 CHIAVI COMBinate

6, 7, 8, 9, 10, 11, 12, 13, 14, 15, 16, 17, 18, 19 mm



FG 102/03H

MODULO RIGIDO 18 CHIAVI COMBinate

6, 7, 8, 10, 11, 12, 13, 14, 16, 17, 18, 19, 21, 22, 24, 27, 30, 32 mm

~~240,00€~~

139,00€



FG 102/03L

~~145,00€~~

79,00€

MODULO RIGIDO 6 CHIAVI COMBinate

21, 22, 24, 27, 30, 32 mm



FG 102/03E

MODULO RIGIDO 8 CHIAVI A DOPPIA FORCHETTA

6x7-20x22 mm + 139C/FS

~~80,00€~~

43,90€



FG 102/03F

MODULO RIGIDO 5 CHIAVI A DOPPIA FORCHETTA

21x23, 24x26, 25x28, 27x29, 30x32 mm

~~86,00€~~

49,90€

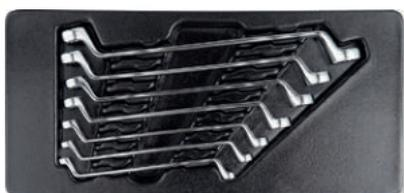

FG 102/07C

~~92,00€~~

52,90€

MODULO 7 CHIAVI DOPPIE POLIGONALI

6x7, 8x9, 10x11, 12x13, 14x15, 16x17, 18x19mm

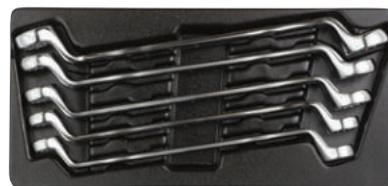

FG 102/07D

~~130,00€~~

75,00€

MODULO 5 CHIAVI DOPPIE POLIGONALI

20x22, 21x23, 24x27, 25x28, 30x32mm



FG 102/08C

~~220,00€~~

129,00€

MODULO 8 CHIAVI COMBinate A CRICCO REVERSIBILE

8, 10, 11, 12, 13, 14, 15, 16, 17, 18, 19mm



FG 102/10C

MODULO 8 CHIAVI A T SNODATE ESAGONALI

7, 8, 10, 11, 13, 14, 17, 19 mm

~~300,00€~~

179,00€



FG 102/13C

~~175,00€~~

99,00€

MODULO 10 CHIAVI A PIPA ESAGONALI-POLIGONALI

6,7,8,10,11,12,13,14, 17,19mm



FG 102/17

MODULO 18 UTENSILI DA 1/4"

4-14mm

~~115,00€~~

64,90€



FG 102/17E

MODULO 65 UTENSILI DA 1/4"

~~265,00€~~

149,00€



FG 102/19

MODULO 18 UTENSILI DA 3/8"
8-23mm ESAGONALI

~~200,80€~~ **115,00€**



FG 102/19B

MODULO 18 UTENSILI DA 3/8"
8-23mm POLIGONALI

~~180,80€~~ **105,00€**



FG 102/21B

MODULO 25 UTENSILI DA 1/2"
10-32mm ESAGONALI

~~220,80€~~ **129,00€**



FG 102/21C

MODULO 25 UTENSILI DA 1/2"
10-32mm POLIGONALI

~~220,80€~~ **129,00€**



FG 102/21E

MODULO 16 UTENSILI DA 1/2"
10-32mm ESAGONALI

~~155,80€~~ **89,00€**



FG 102/21D

MODULO 16 UTENSILI DA 1/2"
10-32mm POLIGONALI

~~145,80€~~ **89,00€**



FG 102/21TX

MODULO 44 UTENSILI TORX

~~235,80€~~ **129,00€**



FG 102/21H

**MODULO RIGIDO INSERTI A
BUSSOLA 1/2" ESAGONALI E XZN**

~~330,80€~~ **115,00€**

FG 102/25

**MODULO
9 UTENSILI DA 3/4"**
34-50mm ESAGONALI

~~395,80€~~
209,00€



FG 102/25B

**MODULO
9 UTENSILI DA 3/4"**
34-50mm POLIGONALI

~~395,80€~~
209,00€



FG 102/21R

MODULO INSERTI A BUSSOLA RIBE
R4-R14, LR4.LR14

~~290,80€~~ **129,00€**



FG 102/23C

MODULO 14 UTENSILI RINFORZATI DA 1/2"
10,11,12,13,14,16,17,18,19,21,22,23,24mm + FG 628/PR125

~~120,80€~~ **69,00€**



FG 102/51H

MODULO 7 CHIAVI A T MASCHIO ESAGONALI
10,11,12,2, 2.5, 3, 4, 5, 6, 8mm

~~120,80€~~ **64,90€**



FG 102/39C

MODULO 3 PINZE SOFT-RUN
FG 59SR/180, FG 61SR/160, FG 63SR/160

~~85,00€~~ **46,90€**



FG 102/39D

MODULO 3 PINZE CON MANICI IN PVC
FG 59PV/180, FG 61PV/160, FG 63PV/160

~~70,00€~~ **39,90€**



CARRELLI E BANCHI DA LAVORO



FG 102/41C

~~95,00€~~

52,90€

MODULO 4 PINZE PER ANELLI ELASTICI

Capacità: 8-25mm



FG 102/42C

~~100,00€~~

59,90€

MODULO 4 PINZE PER ANELLI ELASTICI

Capacità: 19-60mm



FG 102/45D

~~45,00€~~

25,90€

MODULO 6 GIRAVITI AD INTAGLIO E A CROCE PHILLIPS

3x100, 4x125, 5.5x150, 6.5x150, PH1x80, PH2x150



FG 102/45E

~~55,00€~~

32,90€

MODULO 8 GIRAVITI AD INTAGLIO E A CROCE PHILLIPS

3x100, 4x125, 5.5x150, 6.5x150, 6.5x38PH1x80, PH2x150, PH2x38



FG 102/45U

MODULO 12 GIRAVITI AD INTAGLIO E A CROCE PHILLIPS

2.5x60, 3x75, 4x30, 4x100, 5.5x150, 8x150, PH 0x60, PH1x30, PH1x80, PH2x100, PH3x150

~~86,00€~~

49,90€



FG 102/45F

~~52,00€~~

29,90€

MODULO 6 GIRAVITI A CROCE PHILLIPS

PH0x60, PH1x150, PH2x100, PH2x150, PH3x150, PH2x38

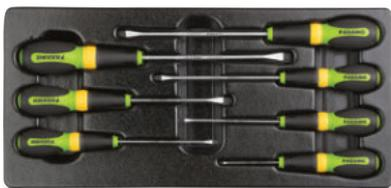

FG 102/45G

~~50,00€~~

27,90€

MODULO 7 GIRAVITI AD INTAGLIO

2.5x60, 3x100, 3.5x100, 4x125, 5.5x150, 5.5x100, 6.5x150



FG 102/45I

~~62,00€~~

34,90€

MODULO 6 GIRAVITI TORX

TX10, TX15, TX20, TX25, TX27, TX30



FG 102/45L

~~65,00€~~

36,90€

MODULO 6 GIRAVITI TORX CON FORO

RTX10, RTX15, RTX20, RTX25, RTX27, RTX30



FG 102/45T

~~65,00€~~

37,90€

MODULO 5 GIRAVITI A BUSSOLA ESAGONALI

FX6, FX7, FX8, FX10, FX13





FG 102/48D ~~95,00€~~ **49,90€**

MODULO 40 INSERTI DA 1/4"
+ PORTA INSERTI



FG 102/48G ~~120,00€~~ **69,90€**

MODULO 52 INSERTI DA 10MM
+ ADATTATORE PER CRICCHETTO DA 1/2"



FG 102/50F ~~76,00€~~ **42,90€**

MODULO 6 CHIAVI MASCHIO



FG 102/50G ~~76,00€~~ **42,90€**

MODULO 6 CHIAVI MASCHIO TORX
TX10, TX15, TX20, TX25, TX27, TX30



FG 102/56C ~~110,00€~~ **64,90€**

MODULO UTENSILI DA PERCUSSIONE
FG 132/500, FG 136/40, FG 126/SN1, FG 126/SN3



FG 102/60C ~~40,00€~~ **23,90€**

MODULO UTENSILI PER MANUTENZIONE
FG 50/MS, FG 48/L, FG 497/OP1, FG 44/MT5



FG 102/62B ~~80,00€~~ **44,90€**

MODULO 5 LIME A TAGLIO MEZZODOLCE



FG 102/62C ~~80,00€~~ **44,90€**

MODULO 5 LIME A TAGLIO BASTARDO



FG 102/65B ~~60,00€~~ **35,90€**

MODULO PINZA AUTOBLOCCANTE
E PINZA REGOLABILE A CERNIERA APERTA



FG 102/VA1 ~~15,00€~~ **8,90€**

MODULO PORTA MINUTERIE



CARRELLI E BANCHI DA LAVORO



NEW

FG 102V/AS205

CARRELLO PORTA UTENSILI FG 102 A 6 CASSETTI CON ASSORTIMENTO 205 UTENSILI IN MODULI DI GOMMA

~~2.455,00€~~

999,00€



KG 800 PORTATA STATICA

CODICE				€/LISTINO	€/PROMO
FG 102D/AS205	FG 102B/AS205	FG 102R/AS205	FG 102V/AS205	2.455,00-	999,00

1°CASSETTO

- FG 100/03G: Modulo 14 chiavi combinate 6 - 19mm
- FG 100/VA1: Modulo porta minuterie
- FG 100/03E: Modulo 8 chiavi a forchetta 6x7-20x22mm + set 9 chiavi maschio esagonali



2°CASSETTO

- FG 100/17E: Modulo 65 utensili da 1/4"
- FG 100/19: Modulo 13 chiavi a bussola esagonali da 3/8" + accessori
- FG 100/21B: Modulo chiavi a bussola esagonali 1/2" 8-32mm + accessori



3°CASSETTO

- FG 100/39C: Modulo 3 pinze assortite
- FG 100/VA1: Modulo porta minuterie
- FG 100/48D: Modulo 40 inserti da 1/4" + porta inserti



4°CASSETTO

- FG 100/45F: Modulo 6 giraviti a croce Phillips
- FG 100/45G: Modulo 7 giraviti a taglio
- FG 100/45I: Modulo 6 giraviti TORX

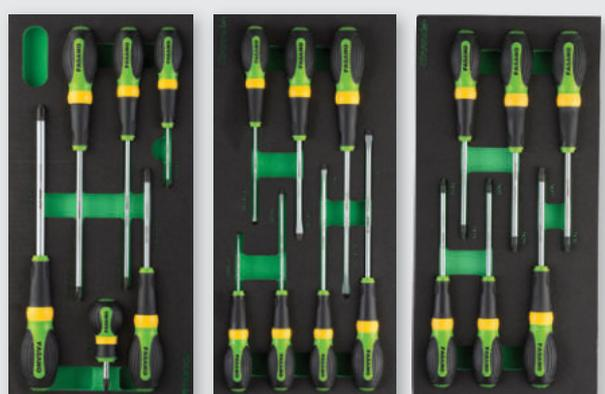



FG 100V/AS226

**CARRELLO PORTA UTENSILI FG 100
A 7 CASSETTI CON ASSORTIMENTO
226 UTENSILI IN MODULI DI GOMMA**

~~2.956,00€~~ **1.149,00€**



KG 800 PORTATA
STATICA

CODICE	€/LISTINO	€/PROMO
FG 100V/AS226	2.956,80	1.149,00

1°CASSETTO

- **FG 100/03G:** Modulo 14 chiavi combinate 6 - 19mm
- **FG 100/17E:** Modulo 65 utensili da 1/4"
- **FG 100/21B:** Modulo chiavi a bussola esagonali 1/2" 8-32mm + accessori

2°CASSETTO

- **FG 100/39C:** Modulo 3 pinze assortite
- **FG 100/VA1:** Modulo porta minuterie
- **FG 100/21TX:** Modulo 44 utensili TORX



3°CASSETTO

- **FG 100/45I:** Modulo 6 giraviti con impronta Torx
- **FG 100/45E:** Modulo 8 giraviti a taglio e croce Phillips
- **FG 100/48G:** Modulo inserti cortie e lunghi con attacco 10mm

4°CASSETTO

- **FG 100/10C:** Modulo 8 chiavi a T snodate 7-19mm





CARRELLI E BANCHI DA LAVORO

NEW



KG 800 PORTATA STATICA

CODICE	€/LISTINO	€/PROMO
FG 150R/AS167	3.012,00	1.249,00

FG 150R/AS167

CARRELLO PORTA UTENSILI A 7 CASSETTI CON ASSORTIMENTO 167 UTENSILI IN MODULI DI GOMMA

~~3.012,00€~~ **1.249,00€**

1°CASSETTO

- **FG 100/03G:** Modulo 14 chiavi combinate 6 - 19mm
- **FG 100/VA1:** Modulo di riempimento con vani porta minuteria
- **FG 100/03E:** Modulo 8 chiavi a forchetta 6x7-20x22mm + set 9 chiavi maschio esagonali



3°CASSETTO

- **FG 100/81F:** Modulo inserti a bussola da 1/2" esagonali e XZN
- **FG 100/42C:** Modulo 4 pinze per anelli elastici 19-60mm
- **FG 100/65B:** Modulo pinze autobloccanti e a cerniera



2°CASSETTO

- **FG 100/17:** Modulo 11 chiavi a bussola da 1/4" esagonali + accessori
- **FG 100/21TX:** Modulo 44 utensili con impronta TORX
- **FG 100/21B:** Modulo chiavi a bussola esagonali 1/2" 8-32mm + accessori



5°CASSETTO

- **FG 100/10C:** Modulo 8 chiavi a T snodate 7-19mm

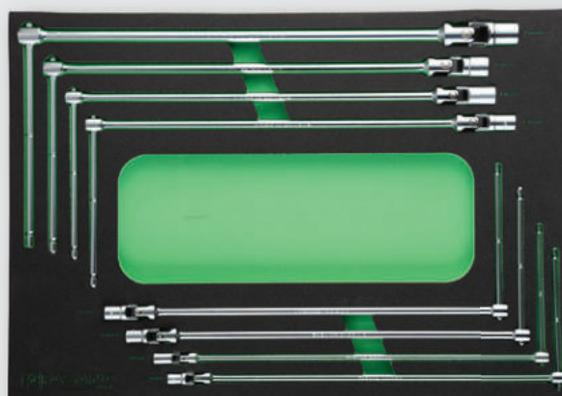

4°CASSETTO

- **FG 100/39C:** Modulo 3 pinze assortite
- **FG 100/VA1:** Modulo di riempimento con vani porta minuteria
- **FG 100/45D:** Modulo 6 giraviti ad intaglio e a croce phillips





NEW

FG 100V/AS228

**CARRELLO PORTA UTENSILI FG 100
7 CASSETTI CON ASSORTIMENTO
228 UTENSILI IN MODULI IN GOMMA**

~~3.701,00€~~ **1.299,00€**



KG 800 PORTATA STATICA

CODICE			€/LISTINO	€/PROMO
FG 100V/AS228	FG 100B/AS228	FG 100R/AS228	3.701,00	1.299,00

1° CASSETTO

- FG 100/03G: Modulo 14 chiavi combinate 6 - 19mm
- FG 100/VA1: Modulo di riempimento con vani porta minuteria
- FG 100/03L: Modulo 6 chiavi combinate



2° CASSETTO

- FG 100/17E: Modulo 65 utensili da 1/4"
- FG 100/21TX: Modulo 44 utensili con impronta Torx
- FG 100/21B: Modulo chiavi a bussola esagonali 1/2" 8-32mm + accessori



3° CASSETTO

- FG 100/81F: Modulo inserti a bussola da 1/2" esagonali e XZN
- FG 100/23C: Modulo 14 utensili a percussione da 1/2"
- FG 100/42C: Modulo 4 pinze per anelli elastici 19-60mm

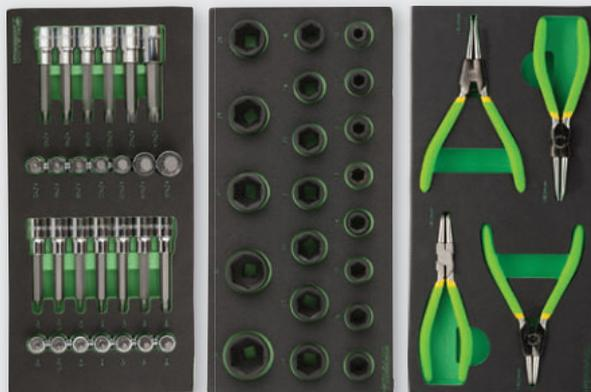

4° CASSETTO

- FG 100/39C: Modulo 3 pinze assortite
- FG 100/45D: Modulo 6 giraviti ad intaglio e a croce phillips
- FG 100/45I: Modulo 6 giraviti con impronta TORX



5° CASSETTO

- FG 100/10C: Modulo 8 chiavi a T snodate esagonali

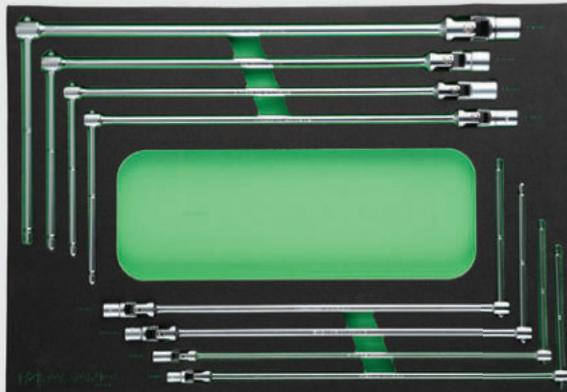



CARRELLI E BANCHI DA LAVORO

NEW

FG 104D/AS242

CARRELLO PORTA UTENSILI FG 104 A 7 CASSETTI CON ASSORTIMENTO 242 UTENSILI IN MODULI DI GOMMA

3.930,00€

1.499,00€



KG 1000 PORTATA STATICA

CODICE				€/LISTINO	€/PROMO
FG 104V/AS242	FG 104D/AS242	FG 104B/AS242	FG 104R/AS242	3.930,00	1.499,00

1°CASSETTO

- FG 100/03G: Modulo 14 chiavi combinate 6 - 19mm
- FG 100/03L: Modulo 6 chiavi combinate 21 - 32mm
- FG 100/VA4: Modulo di riempimento con vani porta minuteria
- FG 100/21H: Modulo 32 chiavi a bussola esagonali da 1/2" 8-32mm + acc.



2°CASSETTO

- FG 100/17E: Modulo 65 utensili da 1/4"
- FG 100/21TX: Modulo 44 utensili con imponta Torx
- FG 100/81F: Modulo inserti a bussola da 1/2" esagonali e XZN
- FG 100/23C: Modulo 20 chiavi a bussola rinforzate da 1/2"



3°CASSETTO

- FG 100/42C: Modulo 4 pinze per anelli elastici 19-60mm
- FG 100/39C: Modulo 3 pinze
- FG 100/45D: Modulo 6 giraviti ad intaglio e a croce Phillips
- FG 100/45I: Modulo 6 giraviti con impronta Torx



4°CASSETTO

- FG 100/65B: Modulo pinza autobloccante e pinza regolabile a cerniera
- FG 100/10C: Modulo 8 chiavi a T snodate esagonal

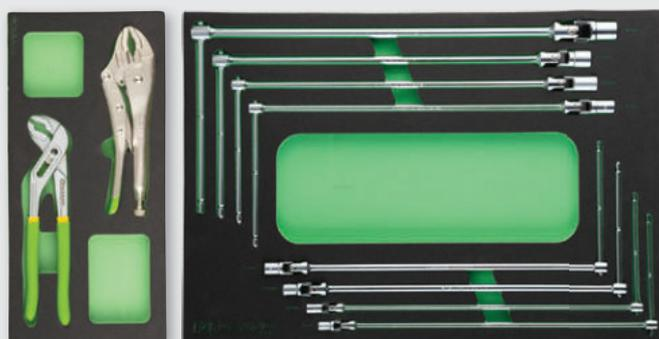



NEW

FG 160V/AS292

CARRELLO PORTA UTENSILI A 14 CASSETTI
MOD. FG 160 CON ASSORTIMENTO
292 UTENSILI IN MODULI DI GOMMA

~~6.140,00€~~

2.899,00€



KG
2.400
PORTATA
STATICA

CODICE			€/LISTINO	€/PROMO
FG 160B/AS292	FG 160R/AS292	FG 160D/AS292	6.140,00	2.899,00

6 CASSETTI COMPLETI DI UTENSILI

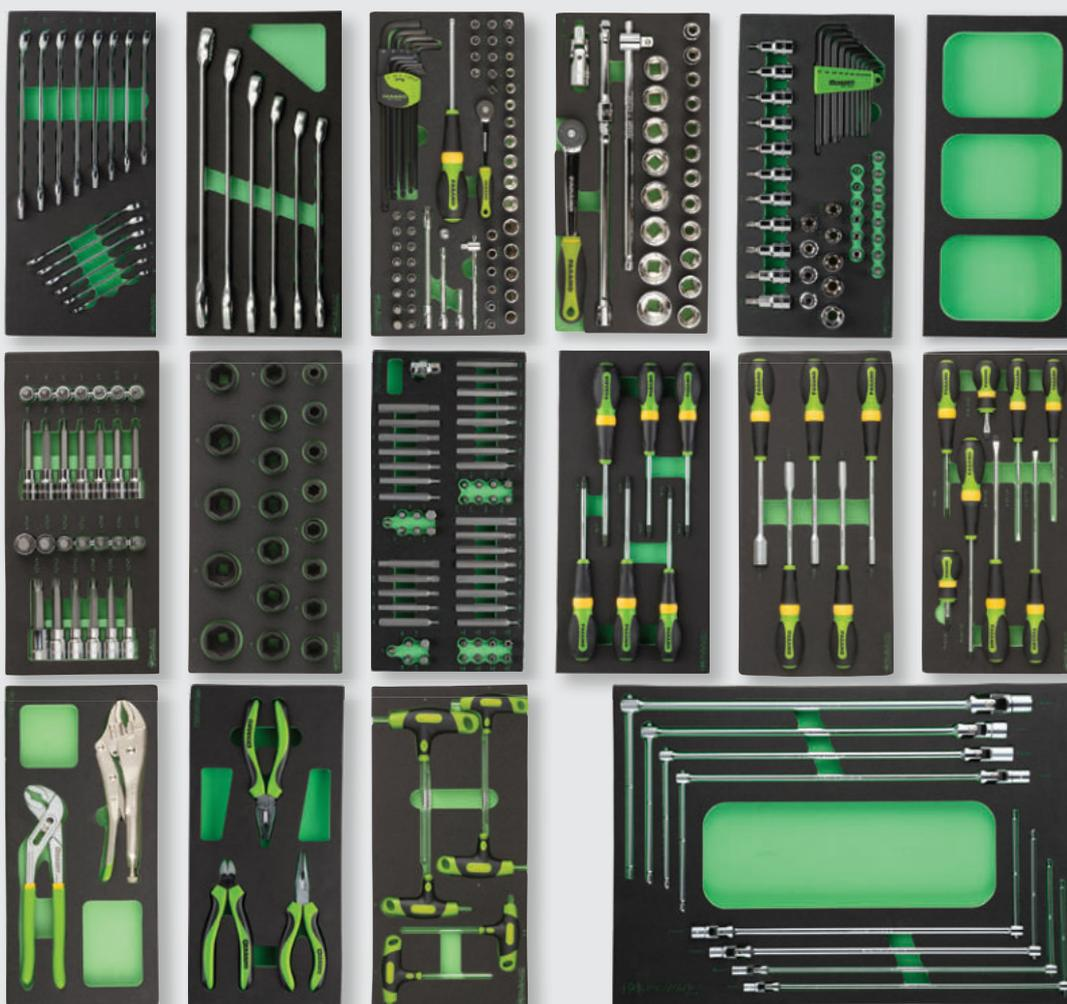

- FG 100/03G: Modulo 14 chiavi combinate 6 - 19mm
- FG 100/03L: Modulo 6 chiavi combinate 21 - 32mm
- FG 100/17E: Modulo 65 utensili da 1/4"
- FG 100/21B: Modulo 25 utensili da 1/2"
- FG 100/21TX: Modulo 44 utensili con impronta Torx
- FG 100/VA1: Modulo di riempimento con vani porta minuteria
- FG 100/81F: Modulo inserti a bussola da 1/2" esagonali e XZN
- FG 100/23C: Modulo 14 utensili a percussione da 1/2"

- FG 100/48G: Modulo 52 inserti da 10mm
- FG 100/45I: Modulo 6 giraviti con impronta TORX
- FG 100/45T: Modulo 6 giraviti a bussola esagonali
- FG 100/45E: Modulo 8 giraviti ad intaglio e a croce Phillips
- FG 100/65B: Modulo pinza autobloccante e pinza regolabile a cerniera aperta
- FG 100/39C: Modulo 3 pinze assortite
- FG 100/50F: Modulo 6 chiavi maschio esagonali con impugnatura
- FG 100/10C: Modulo 8 chiavi a T snodate 7-19mm

THE HYBRID REVOLUTION

UTENSILI ESSENZIALI PER
AFFRONTARE LE NUOVE
SFIDE DEL FUTURO



SPECIALE VEICOLI ELETTRICI

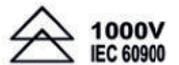

FG 603/S28A

FG 603/S28B

**KIT 26 UTENSILI ISOLATI, COMPLETO DI
ELMETTO DIELETRICO E
GUANTI DIELETRICI 1.000V**

**IDEALE PER INTERVENTI SU
VEICOLI ELETTRICI ED IBRIDI**



FG 59/IS200



FG 625E/CR12



FG 61/IS200



FG 625E/PR250



FG 63/IS160



FG 49/E



FG 603/E10,11,12,
13,14,17,19



FG 48/IS



FG 625E/10,11,12,
13,14,17,19



FG 22/CF250



FG 22E/4X100, 5.5X125,
FG22E/PH1X80, PH2X100



CODICE	TAGLIA GUANTI	LISTINO	€/PROMO
FG 603/S28A	TAGLIA 9	995,00	499,00
FG 603/S28B	TAGLIA 10	995,00	499,00

FG 603/TA1

~~270,00€~~

139,00€

TAPPETO ISOLANTE 1000V

- 1.000x1.000x4mm



ASSORTIMENTO 56 UTENSILI ISOLATI



KG 800 PORTATA
STATICA

FG 100V/AS56

CARRELLO PORTA UTENSILI FG 100 A 6 CASSETTI CON ASSORTIMENTO 56 UTENSILI ISOLATI IN MODULI IN GOMMA

~~3.064,00€~~

1.299,00€

1°CASSETTO

- FG 100/03-IS: Modulo chiavi a forchetta e giraviti isolati
- Chiavi a forchetta isolate 7-19mm
- Giraviti isolati a taglio 2.5x75mm, 3x100mm, 5.5x125mm, 6.5x150mm, 8x175mm
- Giraviti isolati per viti a croce Phillips PH0x60, PH1x80, PH2x100, PH3x150

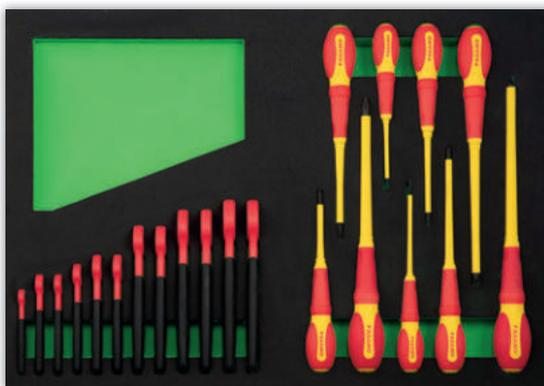

2°CASSETTO

- FG 100/21-IS: Modulo bussole da 1/2 e accessori isolati
- Chiavi a bussola esagonali da 1/2" 10-32mm
- Inserti a bussola esagonali corti e lunghi da 1/2" 4-10mm
- Accessori da 1/2"



3°CASSETTO

- FG 100/39-IS: Modulo pinze e utensili da taglio isolati
- Pinze assortite e tronchese diagonale isolate
- Forbice con manici isolati
- Cutter professionale isolato
- Spellacavi elicoidale



SCEGLI TRA 3 VARIANTI DI COLORE
LA TUA PREFERITA!

Il nuovo carrello porta utensili FG 100 a 6 cassetti è ancora più performante e presenta un assortimento di 56 UTENSILI ISOLATI in moduli in gomma, INDISPENSABILI PER LA MANUTENZIONE DI VEICOLI ELETTRICI E IBRIDI.

RAL
6018

RAL
5002

RAL
3001



CODICE		€/LISTINO	€/PROMO
FG 100V/AS56	FG 100B/AS56	3.064,00	1.299,00



CARRELLI E BANCHI DA LAVORO



FG 100/03G ~~140,00€~~ 79,90€

MODULO 14 CHIAVI COMBinate

6, 7, 8, 9, 10, 11, 12, 13, 14, 15, 16, 17, 18, 19 mm



FG 100/03L ~~145,00€~~ 85,00€

MODULO 6 CHIAVI COMBinate

21, 22, 24, 27, 30, 32mm



FG 100/03E ~~85,00€~~ 49,90€

**MODULO 8 CHIAVI A DOPPIA FORCHETTA
+ SET CHIAVI MASCHIO CON IMPRONTA ESAGONALE**

6x7-20x22 mm + 139C/FS



FG 100/03F ~~90,00€~~ 53,90€

MODULO 5 CHIAVI A DOPPIA FORCHETTA

21x23, 24x26, 25x28, 27x29, 30x32 mm

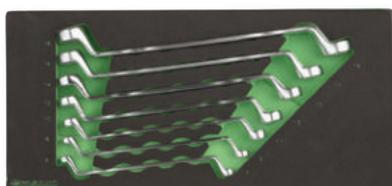

FG 100/07C ~~98,00€~~ 56,90€

MODULO 7 CHIAVI DOPPIE POLIGONALI

6x7, 8x9, 10x11, 12x13, 14x15, 16x17, 18x19mm



FG 100/08C ~~230,00€~~ 139,00€

MODULO 8 CHIAVI COMBinate A CRICCO

8, 10, 11, 12, 13, 14, 15, 16, 17, 18, 19mm



FG 100/10C

MODULO 8 CHIAVI A T SNODATE ESAGONALI

7, 8, 10, 11, 13, 14, 17, 19 mm

~~320,00€~~

189,00€



FG 100/10D

MODULO 12 CHIAVI A T SNODATE ESAGONALI

7, 8, 10, 11, 12, 13, 14, 15, 16, 17, 18, 19 mm

~~460,00€~~

279,00€



FG 100/17 ~~135,00€~~ 75,00€

MODULO 18 UTENSILI DA 1/4"

4-14mm



FG 100/17E ~~285,00€~~ 159,00€

MODULO 65 UTENSILI DA 1/4"



FG 100/21B

MODULO 25 UTENSILI DA 1/2"
10-32mm ESAGONALI

~~240,00€~~ **135,00€**



FG 100/21C

MODULO 25 UTENSILI DA 1/2"
10-32mm POLIGONALI

~~240,00€~~ **135,00€**



FG 100/21M

MODULO 16 UTENSILI DA 1/2"
10-32mm ESAGONALI

~~159,00€~~ **95,00€**



FG 100/21D

MODULO 16 UTENSILI DA 1/2"
10-32mm POLIGONALI

~~159,00€~~ **95,00€**



FG 100/21H

MODULO 32 CHIAVI A BUSSOLA ESAGONALI 1/2" + ACCESSORI
BUSSOLE CORTE: 8-32mm
(esclusa 25mm)
BUSSOLE LUNGHE: 10-32mm

~~430,00€~~ **239,00€**

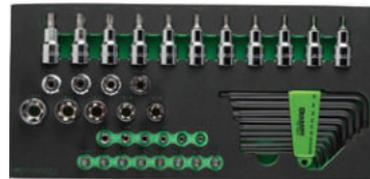

FG 100/21TX

MODULO 44 UTENSILI TORX

~~255,00€~~ **145,00€**

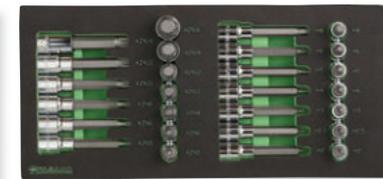

FG 100/81F

MODULO INSERTI A BUSSOLA DA 1/2" ESAGONALI XZN

~~350,00€~~ **159,00€**

FG 100/25

MODULO 9 UTENSILI DA 3/4"
34-50mm ESAGONALI

~~420,00€~~

239,00€



FG 100/25B

MODULO 9 UTENSILI DA 3/4"
34-50mm POLIGONALI

~~420,00€~~

239,00€



FG 100/23C

MODULO 20 UTENSILI RINFORZATI DA 1/2"

10, 11, 12, 13, 14, 15, 16, 17, 18, 19, 20, 21, 22, 23, 24, 25, 26, 27, 30, 32mm

~~220,00€~~ **129,00€**



FG 100/39C

~~95,00€~~ **52,90€**

MODULO 3 PINZE SOFT-RUN
FG 59SR/180, FG 61SR/160, FG 63SR/160



FG 100/65B

~~72,00€~~ **39,90€**

MODULO PINZA AUTOBLOCCANTE E PINZA REGOLABILE A CERNIERA APERTA



FG 100/41C

~~110,00€~~ **63,90€**

MODULO 4 PINZE PER ANELLI ELASTICI
Capacità: 8-25mm



FG 100/42C

~~112,00€~~ **66,90€**

MODULO 4 PINZE PER ANELLI ELASTICI
Capacità: 19-60mm



CARRELLI E BANCHI DA LAVORO



FG 100/45D

~~60,00€~~

33,90€

MODULO 6 GIRAVITI AD INTAGLIO E A CROCE PHILLIPS
3x100, 4x125, 5.5x150, 6.5x150, PH1x80, PH2x150



FG 100/45E

~~72,00€~~

39,90€

MODULO 8 GIRAVITI AD INTAGLIO E A CROCE PHILLIPS
3x100, 4x125, 5.5x150, 6.5x150, 6.5x38PH1x80, PH2x150, PH2x38



FG 100/45I

~~75,00€~~

42,90€

MODULO 6 GIRAVITI TORX
TX10, TX15, TX20, TX25, TX27, TX30



FG 100/45T

~~80,00€~~

44,90€

MODULO 5 GIRAVITI A BUSSOLA ESAGONALI
FX6, FX7, FX8, FX10, FX13



FG 100/45H

~~80,00€~~

44,90€

MODULO 5 GIRAVITI EXTRA LUNGHI

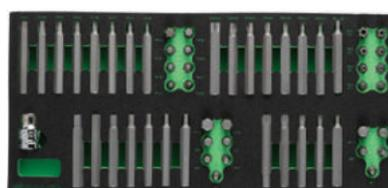

FG 100/48G

~~130,00€~~

75,00€

MODULO 52 INSERTI DA 10MM

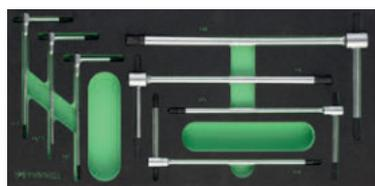

FG 100/51H

~~130,00€~~

75,00€

MODULO 7 CHIAVI MASCHIO ESAGONALI
2, 5, 3, 4, 5, 6, 8mm



FG 100/54

~~135,00€~~

79,90€

MODULO 5 UTENSILI DI MISURAZIONE



FG 100/56C

~~125,00€~~

72,50€

MODULO UTENSILI DA PERCUSSIONE
FG 132/500, FG 136/40, FG 126/SN1, FG 126/SN3



FG 100/VA1

~~24,00€~~

13,90€

MODULO VUOTO PORTA MINUTERIE



FG 107/A

CARRELLO PORTA ATTREZZI IN LAMIERA D'ACCIAIO

- Dimensione: 380x730x780mm
- 2 ruote fisse e 2 ruote girevoli con freno (Ø 100mm)
- Peso totale: 16.4Kg

~~198,00€~~

99,00€



**MANIGLIONE LATERALE
IN LAMIERA D'ACCIAIO**



**4 RUOTE Ø 100MM
(2 GIREVOLI FRENANTI
E 2 FISSE)**



**RIPIANO CON BORDO RIALZATO
(PROFONDITA' 75MM)**



FG 106/B

CARRELLO PORTA ATTREZZI IN LAMIERA D'ACCIAIO

- Dimensione: 460x930x885mm
- Lamiera d'acciaio 1.5mm
- Ruote montate su supporto rotante a piastra con gruppo rotante realizzato con doppia corona di sfere
- 2 ruote fisse, 1 girevole + 1 girevole con freno (Ø100mm)
- Peso totale: 22.0Kg

~~290,00€~~

169,00€



FG 106/C

CARRELLO PORTA ATTREZZI IN LAMIERA D'ACCIAIO - MOD. GIGANTE

- Dimensione: 560x1.000x950mm
- Lamiera d'acciaio 2.0mm
- Ruote montate su supporto rotante a piastra con gruppo rotante realizzato con doppia corona di sfere
- 2 ruote fisse, 1 girevole + 1 girevole con freno (Ø125mm)
- Peso totale: 44.0Kg

~~390,00€~~

199,00€



CARRELLI E BANCHI DA LAVORO



FG 129/D2

**BANCO DA LAVORO 2MT
CON CASSETTI DI COLORE GRIGIO DARK**

Peso totale: 106,50Kg
Dimensione: 2.000x745x880mm

~~1.012,00€~~



539,00€

MADE IN ITALY



FG 129/B2



FG 129/R2



FG 129/GR1

**PANNELLO FORATO DOTATO
DI MENSOLA PORTA OGGETTI**

Dimensione: 945x120x860mm

~~160,00€~~



85,00€

FG 129/BR1

FG 129/RR1

FG 129/GR1

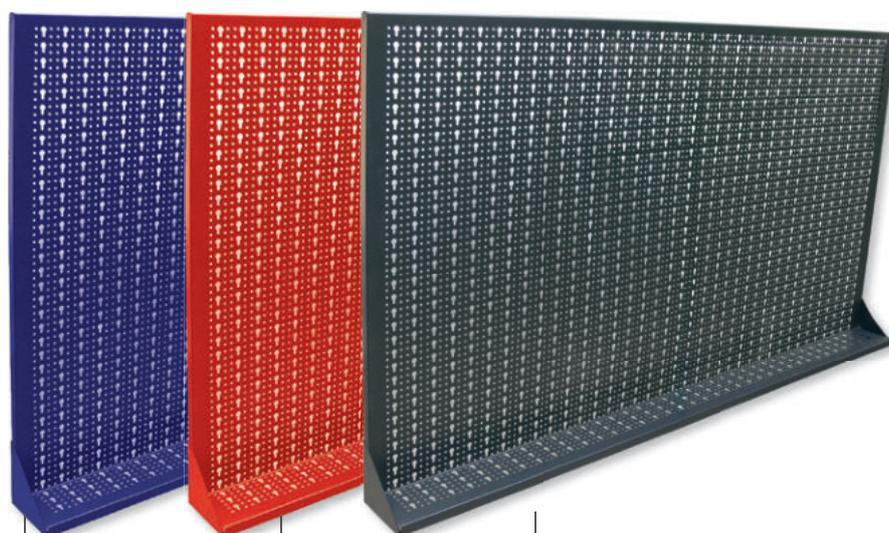

FG 129/GR1.5

**PANNELLO FORATO DOTATO
DI MENSOLA PORTA OGGETTI**

Dimensione: 1.440x120x860mm

~~225,00€~~



119,00€

FG 129/BR1.5

FG 129/RR1.5

FG 129/GR1.5



FG 129/LD2

BANCO DA LAVORO 2.0MT CON CASSETTI DI COLORE GRIGIO DARK

Peso totale: 106,50Kg

Dimensione: 2.000x745x900mm

~~980,00€~~

499,00€

- Ripiano superiore in legno multistrato laminato 25mm
- Ripiano inferiore in lamiera d'acciaio 1,5mm fornita di serie
- 3 montanti
- 2 cassetti dotati di sistema di chiusura con chiave
- Predisposizione per fissaggio a pavimento
- Struttura verniciata con vernice epossidica

MADE IN ITALY



FG 129/LR2



FG 129/LB2



FG 131/FD2

BANCO DA LAVORO 2.0MT CON RIPIANO IN FAGGIO, CASSETTIERA 5 CASSETTI

Dimensione: 2.000x745x910mm

~~1.800,00€~~

859,00€

MADE IN ITALY



FG 131/FR2



FG 131/FB2



CARRELLI E BANCHI DA LAVORO



FG 131/D2

**BANCO DA LAVORO 2.0MT CON RIPIANO
IN ACCIAIO, CASSETTIERA 5 CASSETTI**

Dimensione: 2.000x745x920mm

~~1.700,00€~~

899,00€

MADE IN ITALY



FG 131/R2



FG 131/B2



FG 132/D2

**BANCO DA LAVORO 2.0MT CON RIPIANO
IN ACCIAIO, 2 CASSETTIERE 5 CASSETTI**

Dimensione: 2.000x745x920mm

~~2.350,00€~~

1.249,00€

MADE IN ITALY



FG 132/R2



FG 132/B2



FG 137/D1.5

**BANCO DA LAVORO 1.5MT
CON VASCA DI RACCOLTA
DI COLORE GRIGIO DARK
E RUOTE GIREVOLI**

Peso totale: 90,00Kg
Dimensione: 1.500x745x880mm

~~1.400,00€~~ **699,00€**



FG 137/R1.5



FG 131/B2

RIPIANO MICRO FORATO

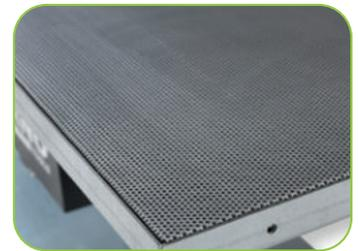

FG 131/A1

**BANCO DA LAVORO 1.0MT
- RIPIANO IN ACCIAIO INOX
E RUOTE GIREVOLI (2 FRENANTI)**

Dimensione: 1.000x750x920 mm

~~1.350,00€~~ **699,00€**



FG 131/D1

**BANCO DA LAVORO 1.0MT
- RIPIANO IN LAMIERA D'ACCIAIO
E RUOTE (2 FRENANTI)**

Dimensione: 1.000x750x920 mm

~~1.050,00€~~ **549,00€**



ARREDAMENTO TECNICO

RAL 6018

RAL 5002

RAL 3001

Il meglio del made in Italy

Personalizza i tuoi spazi di lavoro!

I prodotti Fasano Tools sono frutto di un intenso lavoro di ricerca, sviluppo e progettazione interna. La vasta gamma di prodotti che proponiamo è caratterizzata da attenzione e cura per i dettagli, ma anche da stile e design.



MADE IN ITALY



PRESE IN DOTAZIONE
PRESA 220V A 2 POLI
+ 1 PRESA SHUKO A
2 POLI + USB



MODULO DISTRIBUZIONE
OLIO, DOTATO DI
2 PISTOLE DIGITALI
CONTA LITRI



PENSILI DOTATI DI
PISTONI A GAS
PER AGEVOLARE
L'APERTURA/CHIUSURA
DELLO SPORTELLO



VANO PORTA RIFIUTI
MONTATO SU GUIDE
TELESCOPICHE



PIANO DI LAVORO
IN ACCIAIO INOX
E VASCA DI RACCOLTA
ESTRAIBILE



CASSETTI PREDISPOSTI
PER L'INSERIMENTO
DEI MODULI COMPLETI
DI UTENSILI



DIMENSIONI: 2.050X757X2.000mm

MADE IN ITALY

FG 118/C013V

CONFIGURAZIONE DI ARREDAMENTO
TECNICO DA 2.050MM

CONFIGURAZIONE COMPOSTA DA:

- FG 118/69V7 (Cassettera fissa a 7 cassetti)
- FG 118V/40F (Modulo porta carta, dotato di cassetto porta rifiuti)
- FG 118V/69A (Modulo armadietto a 2 antine)
- 02 griglie porta utensili **complete di illuminazione LED**
- 02 prese di corrente composte da 1 presa 220V a 2 poli, 1 presa Shuko a 2 poli, USB.

~~5.600,00€~~

2.849,00€

NEW



FG 118/C013B



FG 118/C013R



DIMENSIONI: 2.050X757X2.000mm

MADE IN ITALY

FG 118/C02V

CONFIGURAZIONE DI ARREDAMENTO
TECNICO DA 2.050MM

CONFIGURAZIONE COMPOSTA DA:

- FG 118V/69A (Modulo armadietto a 2 antine)
- FG 118V/7T (Cassettera mobile a 7 cassetti)
- FG 118V/40F (Modulo porta carta, dotato di cassetto porta rifiuti)
- 02 pensili superiori dotati di pistoni a gas e serratura di chiusura
- 02 griglie porta utensili
- 01 presa di corrente composta da 1 presa 220V a 2 poli, 1 presa Shuko a 2 poli, USB

~~5.840,00€~~

2.999,00€



FG 118/C02B



FG 118/C02R



ARREDAMENTO TECNICO



DIMENSIONI: 2.050X757X2.000mm

MADE IN ITALY

FG 118/C05V

CONFIGURAZIONE DI ARREDAMENTO TECNICO DA 2.050MM

CONFIGURAZIONE COMPOSTA DA:

- FG 118V/69A (Modulo porta rifiuti completo di contenitori interni in plastica)
- FG 118M/40D (Modulo distribuzione aria compressa)
- FG 118/69V7 (Cassettiera fissa a 7 cassetti)
- 01 griglia porta utensili dotata di sistema di chiusura a tapparella
- Vano porta oggetti a 3 ripiani
- 02 prese di corrente composte da 1 presa 220V a 2 poli, 1 presa Shuko a 2 poli cadauna, USB

~~7.080,00€~~

3.799,00€



FG 118/C05B



FG 118/C05R



DIMENSIONI: 1.225X757X2.000mm

MADE IN ITALY

FG 118/C08V

CONFIGURAZIONE DI ARREDAMENTO TECNICO DA 1.220M DOTATA DI PENSILE SUPERIORE E GRIGLIA PORTA UTENSILI

CONFIGURAZIONE COMPOSTA DA:

- FG 118/69V7 (Cassettiera fissa a 7 cassetti)
- FG 118M/40F (Modulo porta carta, dotato di cassetto porta rifiuti)
- Pensile superiore dotato di pistoni a gas e serratura di chiusura
- 01 griglia porta utensili semplice
- 02 prese di corrente composte da 1 presa 220V a 2 poli, 1 presa Shuko a 2 poli cadauna, USB

~~3.770,00€~~

1.999,00€



FG 118/C08B



FG 118/C08R

FG 118/C020V

CONFIGURAZIONE DI ARREDAMENTO TECNICO DA 5.600MM

~~14.420,00€~~

7.599,00€

CONFIGURAZIONE COMPOSTA DA:

- 04 pensili superiori dotati di pistoni a gas
- FG 118V/69A (Modulo armadietto a 2 antine)
- FG 118V/7T (Cassettiera mobile a 7 cassetti)
- FG 118V/40F (Modulo porta carta dotato di cassetto porta rifiuti)
- FG 118V/69E (Modulo porta rifiuti, dotato di contenitori interni in plastica)
- FG 118M/40D (Modulo distribuzione aria compressa)
- FG 118/69V7 (Cassettiera fissa a 7 cassetti)
- FG 118/AR1V (Armadietto laterale da 500mm)
- FG 118/AR3V (armadietto laterale da 1.000mm a 2 antine e cassettiera interna)

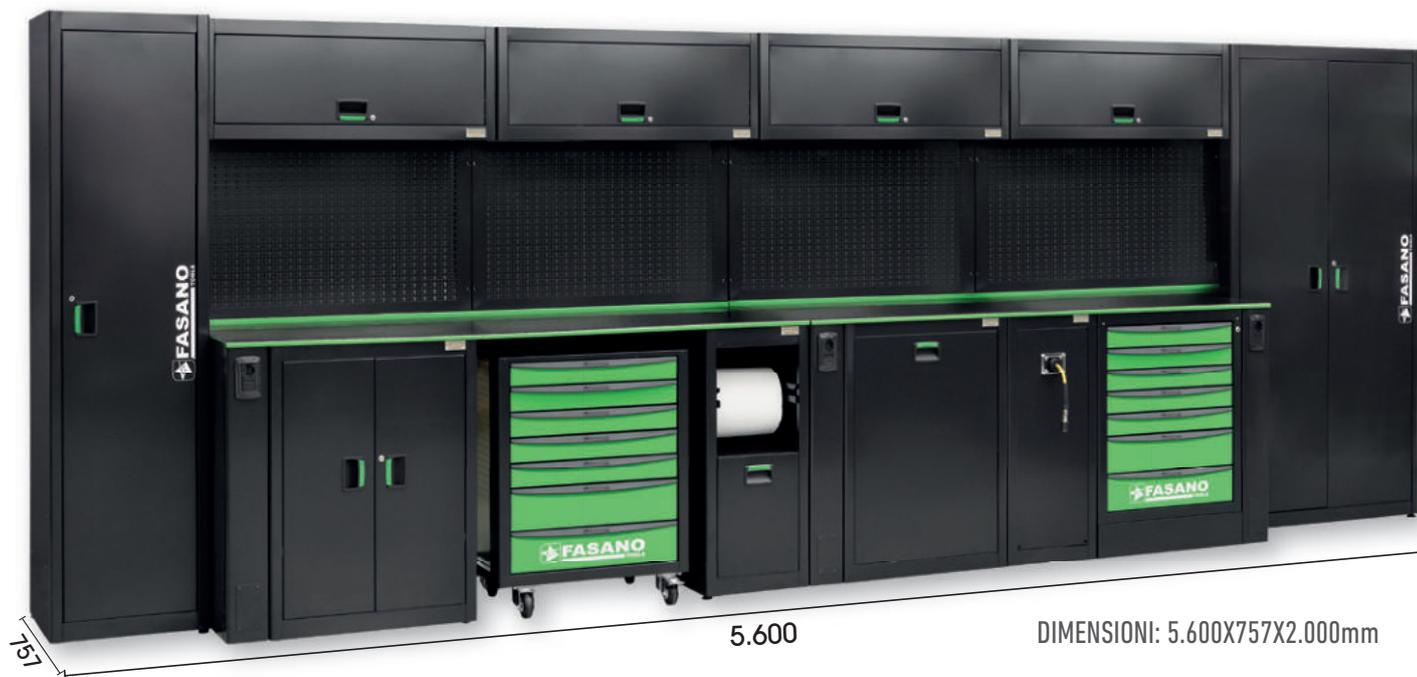

FG 118/C020B



FG 118/C020R





AUTOMOTIVE



**CHIAVE A NASTRO
REGOLABILE PER FILTRI OLIO**

CODICE	Ø MM	LISTINO	€/PROMO
FG 176/RP	65-110	42,00	24,90
FG 176/RP2	110-150	45,00	26,90



**CHIAVE SNODATA A
CATENA DOPIA PER FILTRI OLIO**

CODICE	Ø MM	LISTINO	€/PROMO
FG 176/F01	60-110	82,00	49,90
FG 176/F02	60-160	88,00	52,90

FG 175/F074 ~~44,00€~~ **24,90€**

**CHIAVE A TAZZA PER FILTRI OLIO
FORD 1.0,2.0,2.3 ECOBOOST**



3/8"

FG 175/F074.5
**CHIAVE A TAZZA PER FILTRI OLIO
FORD 1.5, 1.6 ECOBOOST**



~~44,00€~~ **24,90€**

FG 175/F084

**CHIAVE A TAZZA PER FILTRI
OLIO MOTORI MERCEDES**

~~55,00€~~ **32,90€**



1/2"

FG 175/HI

**CHIAVE A TAZZA PER FILTRI OLIO
MOTORE HYUNDAI TUCSON**

~~60,00€~~ **34,90€**



1/2"



FG 175/S6 ~~60,00€~~ **34,90€**

SET 6 CHIAVI A TAZZA PER
CARTUCCE FILTRI OLIO



FG 175/S30

SET 28 CHIAVI A TAZZA
PER FILTRI OLIO

~~215,00€~~ **115,00€**



FG 175/S15

SET 15 CHIAVI A
BUSSOLA MAGNETICHE
PER TAPPI OLIO

~~130,00€~~ **79,00€**

CONTENUTO:

- 8,10,12,14,17 mm
- 13,14,17,18,19,21 mm
- ⊕ TX45



FG 175/S4

SET UTENSILI PER
SMONTAGGIO TAPPI
OLIO IN PLASTICA

~~70,00€~~ **34,90€**

- Adatto a:
- VAG TFSI e TDI
 - FORD
 - BMW
 - CITROEN/PEUGEOT



SET 3 TAPPI OLIO IN PLASTICA
MOTORI VAG TFSI E TDI

VAG 1.8, 2.0 TSI/TFSI
VAG 1.6, 2.0 TDI

FG 175/P0 ~~13,50€~~ **7,90€**



TAPPO OLIO IN PLASTICA
MOTORI FORD

FORD 1.5, 1.6 TDCI
FORD 1.0, 1.6 EcoBoost
FORD 1.5 - 5.2 benzina
FORD 6.2, 6.7, 6.8 diesel

FG 175/P02 ~~13,50€~~ **7,90€**



TAPPO OLIO IN PLASTICA
MOTORI FORD/PSA

FORD 2.0 TDCI
PSA 2.0 HDI

FG 175/P01 ~~11,50€~~ **6,90€**



TAPPO OLIO IN PLASTICA
MOTORI BMW

BMW 1.6 N13/N20
BMW 1.6, 2.0 N26

FG 175/P03 ~~11,50€~~ **6,90€**



AUTOMOTIVE

FG 203/S20

KIT PER IL CONTROLLO
TENUTA DELL'IMPIANTO
DI RAFFREDDAMENTO

~~370,00€~~ 199,00€



21Pz



FG 203/BW1

BMW



FG 203/F01

FORD Fiesta
dal 2008



FG 203/F02

FORD



FG 203/OP1

OPEL



FG 203/T01

TOYOTA

TAPPI OPTIONAL

CODICE	LISTINO	€/PROMO
FG 203/BW1	35,00	21,00€
FG 203/F01	35,00	21,00€
FG 203/F02	35,00	21,00€
FG 203/OP1	35,00	21,00€
FG 203/T01	35,00	21,00€

FG 202/PV

POMPA DI PRESSIONE
E DEPRESSIONE

~~210,00€~~ 119,00€



FG 203/S7

STRUMENTO PER IL RIEMPIMENTO A DEPRESSIONE DEI
CIRCUITI DI RAFFREDDAMENTO

- Utile per effettuare uno spurgo
perfetto grazie alla messa sotto
vuoto del circuito di raffreddamento

~~160,00€~~ 95,00€

FG 176/S13

POMPA PER
INSERIMENTO OLIO
CAMBI E DIFFERENZIALI

Capacità 7,5 litri



~~430,00€~~ 252,00€

- Fornito di 12 accessori per connessione diretta
- Dotato di valvola di non ritorno

FG 203/A

CHIAVE A BUSSOLA PER
SMONTAGGIO TAPPI RADIATORE

~~23,00€~~ 9,90€

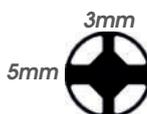



FG 191/S22

~~600,00€~~

349,00€

SET UNIVERSALE PER ESTRAZIONE ELETTRO-INIETTORI BOSCH, DELPHI, SIEMENS E DENSO

- completo di massa battente 4.8KG

CODICE	DESCRIZIONE	APPLICAZIONE
FG 191/ES-1	Adattatore M14X1.5	Delphi
FG 191/ES-2	Adattatore M16X1.5	
FG 191/ES-3	Adattatore M25X0.5	Denso
FG 191/ES-4	Adattatore M25X0.75	Denso
FG 191/ES-5	Adattatore M27X1.0	Bosch
FG 191/ES-6	Adattatore M16X1.0	Denso
FG 191/ES-7	Adattatore M17X1.0	Bosch
FG 191/ES-8	Adattatore M20X1.0	Denso
FG 191/ES-9	Adattatore M25X1.0	Siemens
FG 191/ES-10	Adattatore M27X1.0	Siemens
FG 191/ES-11	Estrattore a forchetta Ø 12 mm	Bosch
FG 191/ES-12	Estrattore a forchetta Ø 13.5 mm	Bosch
FG 191/ES-13	Estrattore a forchetta Ø 16 mm	
FG 191/ES-14	Estrattore a forchetta Ø 26 mm	
FG 191/ES-15	Giunto snodato	
FG 190/A25	Bussola rimozione connessione elettrica 25mm	Siemens
FG 190/A27	Bussola rimozione connessione elettrica 27mm	Siemens
FG 190/A29	Bussola rimozione connessione elettrica 29mm	Bosch
FG 190/A30	Bussola rimozione connessione elettrica 30mm	Bosch
FG 190/EL	Attrezzo rimozione elettrodo ø 7.5mm	
FG 190/EL1	Attrezzo rimozione elettrodo ø 6.9mm	



FG 190/RI

~~56,00€~~

33,90€

ESTRATTORE PER RONDELLE INIETTORI



FG 190/AD1

ESTRATTORE A FORCHETTA PER INIETTORI PIEZO ELETTRICI

~~52,00€~~

29,90€

FG 190/AD2

ESTRATTORE LATERALE PER ELETTRO-INIETTORI BOSCH

~~34,00€~~

19,90€

Per le masse battenti da associare ai codici FG 190/AD e FG 190/AD2 consultare il Catalogo generale a pagina 175



FG 190/S6B

SET PER FRESATURA SEDI INIETTORI

CONTENUTO:

- 01 fresa piana 17x19mm
- 01 fresa piana 15x19mm
- 01 fresa piana 17x17mm
- 01 fresa conica 17x21mm
- 01 fresa conica 17x17mm

~~150,00€~~

89,00€



FG 201/CR

SET PER VERIFICA ELETTRO-INIETTORI DIESEL COMMON RAIL

- supporto a 6 burette
- adattato per BOSCH, SIEMENS, DENSO e DELPHI

~~240,00€~~

139,00€



AUTOMOTIVE

FG 174/F2

~~70,00€~~

42,50€

CHIAVE REGOLABILE PER
GHIERE GALLEGGIANTI
SERBATOIO CARBURANTE
GRUPPO FCA

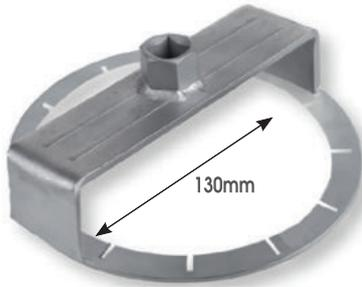

FG 175/FT1

~~65,00€~~

39,00€

CHIAVE PER
GHIERE GALLEGGIANTI
SERBATOIO CARBURANTE

per ghiera in alluminio Fiat, VW,
Opel, Mercedes, BMW



1/2"
22mm

FG 175/FT2

CHIAVE PER
GHIERE GALLEGGIANTI
SERBATOIO CARBURANTE

per ghiera in plastica
Citroen e Peugeot

~~80,00€~~

49,00€



FG 175/FT3

CHIAVE REGOLABILE PER
GHIERE GALLEGGIANTI
SERBATOIO CARBURANTE

per ghiera in plastica
FCA (Fiat Freemont, 500L,
500X, Jeep Renegade, ecc)

~~80,00€~~

49,00€



FG 175/FT4

~~70,00€~~

42,50€

CHIAVE PER
GHIERE GALLEGGIANTI
SERBATOIO CARBURANTE

per ghiera in plastica gruppo VAG

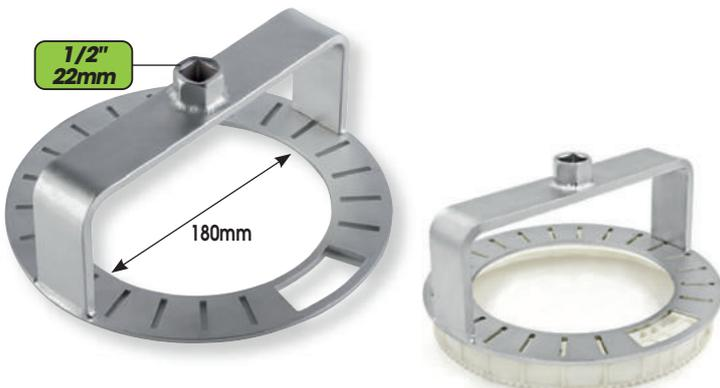

FG 175/FT5

CHIAVE PER
GHIERE GALLEGGIANTI
SERBATOIO CARBURANTE

per ghiera in alluminio
gruppo OPEL

~~70,00€~~

42,50€





FG 182/S16

**SET ESTRAZIONE
CANDELETTE SPEZZATE**
M8, M10, MULTIJET

~~460,00€~~ **259,00€**



FG 179/S16

**SET UTENSILI PER PULEGGE
LIBERE ALTERNATORI**

~~145,00€~~ **82,50€**

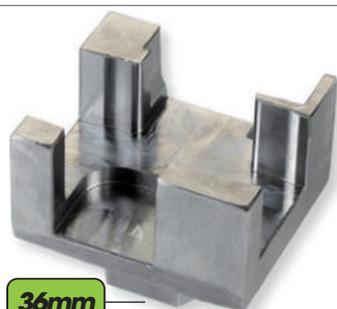

FG 800/2

**CHIAVE SMONTAGGIO
VALVOLA METANO**
FIAT MULTIPLA e PUNTO
(VBE 517, VBE 520, VBE 474 e VALE 110)

~~120,00€~~ **69,00€**

36mm



FG 800/5

**CHIAVE SMONTAGGIO
VALVOLA METANO**
Per Opel ZAFIRA

~~120,00€~~ **69,00€**

36mm



FG 800/3

**CHIAVE SMONTAGGIO
VALVOLA METANO**
FIAT PANDA, PUNTO EVO,
VOLKSWAGEN

~~120,00€~~ **69,00€**

32mm



FG 800/6

**CHIAVE SMONTAGGIO
VALVOLA METANO**
Per valvole
metano MCR 110

~~120,00€~~ **69,00€**

36mm



FG 800/7

**CHIAVE SMONTAGGIO
VALVOLA METANO**
FIAT PANDA

~~120,00€~~ **69,00€**

36mm



FG 800/9

**CHIAVE SMONTAGGIO
VALVOLE GPL GRUPPO VAG**

~~145,00€~~ **79,00€**



1/2"



FG 800/8

**CHIAVE SMONTAGGIO
VALVOLA METANO**
Per Citroen C4 Picasso

~~120,00€~~ **69,00€**

36mm



AUTOMOTIVE

FG 178/BF

ASPIRATORE PNEUMATICO PER LIQUIDO FRENI

- capacità: 2 Litri
- dotato di sonde e attacchi universali

~~255,00€~~ 149,00€



FG 199/SF

SIRINGA PER ESTRAZIONE OLIO CIRCUITO FRENI

- Capacità: 200CC
- Dotata di attacchi specifici per raccordi circuito freno
- Guarnizione interna in VITON

NEW

~~60,00€~~ 36,00€



FG 178/SF

~~1.650,00€~~ 849,00€

APPARECCHIO SPURGO LIQUIDO FRENI

- alimentazione 12V con cavi batteria
- dotato di vano posteriore porta oggetti e contenitore di recupero olio
- 2 tappi universali in dotazione

TAPPI IN DOTAZIONE



TAPPI SPECIFICI PER MOTORI FORD (NON IN DOTAZIONE DI BASE)



FG 178SF/AD13
Fiesta 2011-2016

~~55,00€~~ 31,90€



FG 178SF/AD14
Mondeo dal 2014
Fiesta dal 2016
Mazda CX3/CX5

~~55,00€~~ 31,90€



PRESSIONE REGOLABILE FINO A 2 BAR

CAPACITÀ SERBATOIO 5L

SCocca IN ACCIAIO INOX

DOTATO DI SENSORE FINE LIQUIDO



FG 178/S6

KIT TAPPI PER VEICOLI ASIATICI

- TOYOTA
- HYUNDAI
- NISSAN
- MITSUBISHI
- MAZDA
- SUBARU
- HONDA
- SUZUKI

~~330,00€~~ 189,00€

FG 199/PF

SET ARRETRATORE PNEUMATICO PER PISTONCINI FRENI A DISCO

Per destrorsi e sinistrorsi

~~220,00€~~ 119,00€



FG 628/R18.5

CHIAVE A BUSSOLA RINFORZATA PER DADI BULLONI FORD

Misura: 18.5x19.5mm
Attacco quadro interno: 1/2"

~~20,00€~~ 11,90€

NEW



1/2"

FG 627/S3

CHIAVI A BUSSOLA PER CERCHI IN LEGA LEGGERA

17, 19, 21mm



~~85,00€~~ 44,90€

DOTATE DI ANELLO MAGNETICO DI TENUTA

1/2"

FG 628/S3

CHIAVE A BUSSOLA ESAGONALE PER MOZZI RUOTA

17, 19, 21mm



~~50,00€~~ 29,90€

KIT PER RIMOZIONE DADI ANTIFURTO

NEW



FG 164/S3

KIT RIMOZIONE DADI ANTI FURTO CON COLLARE - BMW

Completo di massa battente e box in ABS

~~250,00€~~ 129,00€

FG 164/S3B

KIT RIMOZIONE DADI ANTI FURTO CON COLLARE - BMW

Da usare con massa battente FG 190MI - FG 190/MI2

~~165,00€~~ 89,00€

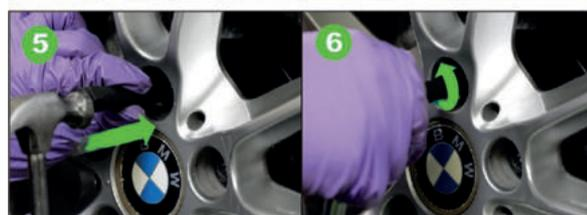



AUTOMOTIVE



FG 199/FM

PINZA PER FERMI MOLLE
CEPPI FRENI A TAMBURO

~~30,00€~~ **17,90€**

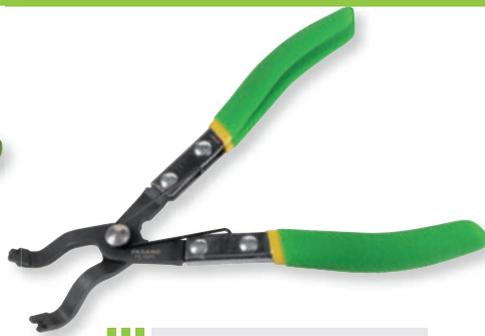

FG 165/FC

PINZA PER FERMI
CUSCINETTI MOZZO

~~48,00€~~ **24,90€**



FG 198/DG

CALIBRO DIGITALE DI PROFONDITÀ
PER BATTISTRADA PNEUMATICI

~~33,00€~~ **19,90€**



FG 169/A44

CHIAVE A BUSSOLA PER SNODI
SFERICI PSA

~~55,00€~~ **29,90€**



FG 159/PM

KIT PRESSORI PER AMMORTIZZATORI
DOTATO DI 2 COPPIE DI BARRE FILETTATE
L/mm max 65-200mm/65-370mm

~~210,00€~~ **119,00€**



FG 165/G01

ESTRATTORE PER
GIUNTI OMOCINETICI

~~246,00€~~ **99,00€**



FG 169/1

ESTRATTORE
PER SNODI SFERICI

Ømm 19

~~57,00€~~ **34,90€**



FG 169/2

ESTRATTORI
PER SNODI SFERICI

Ømm 22

~~74,00€~~ **44,90€**





Scocca anteriore in acciaio resistente agli urti



Led di puntamento

Impugnatura Bi-material per un maggior grip

Sistema di sgancio rapido

Aggancio rinforzato

Batteria al Litio 5.0 Ampere e 18 Volt

18V-5.0A

Coppia massima



BRUSHLESS MOTOR

Fornito in valigetta di ABS con 1 caricabatterie

Modalità L: -900RPM
-1.200 colpi per minuto

Modalità H: -1.900RPM
-2.400 colpi per minuto



Modalità M: -1.200RPM
-1.600 colpi per minuto
Modalità svitamento soft: permette di applicare una velocità controllata finché che il bullone risulta ancora bloccato



FG 166/LT2 ~~1.065,00€~~ **439,00€**

AVVITATORE AD IMPULSI 18V (KIT CON 1 BATTERIA)



FG 166/LT ~~850,00€~~ **379,00€**

AVVITATORE REVERSIBILE AD IMPULSI 18V



AVVIATORI

CODICE	VOLT	CORRENTE DI SPUNTO	LISTINO	€/PROMO
FG 99	12	2.000A	550,00	289,00
FG 99/B	12	2.500A	670,00	355,00
FG 99/C	12 - 24	5.000A (A 12V)-2.500A (A 24V)	1.980,00	999,00



CARATTERISTICHE TECNICHE:

- Batteria ermetica al piombo (AGM)
- Alimentazione: 220V e accendisigari 12V



AUTOMOTIVE

FG 184/S24

KIT MONTAGGIO E SMONTAGGIO MAGLIE CATENE DI DISTRIBUZIONE

~~410,00€~~ 239,00€

FG 172/TC

PINZA PER RIMOZIONE PIOLI CATENE

~~54,80€~~ 29,90€

FG 172/FA

PINZA PER FASCETTE A SCATTO CLIC

~~70,80€~~ 39,90€

FG 172/TG

PINZA RIMOZIONE TUBI ACQUA E CARBURANTE

~~49,50€~~ 19,90€

FG 172/AS2

PINZA PER ANELLI STRINGITUBO CON PROLUNGA INTERCAMBIABILE

-Apertura: 3-52mm

~~108,00€~~ 62,90€

PROLUNGHE SINGOLE

CODICE	APERTURA	LISTINO	€/PROMO
FG 172/AS2-A	3-52MM	26,80	14,90
FG 172/AS2-B	0-75MM	50,80	29,90
FG 172/AS2-C	0-24MM	30,80	17,90
FG 172/AS2-D	PER CONNETTORI CARBURANTE	33,80	19,90





FG 184/S5 ~~140,00€~~ **85,00€**

SET 5 CHIAVI PER DADI TENDICINGHIA

13, 15, 16, 17, 19mm

FG 184/S6 ~~95,00€~~ **49,00€**

SET CHIAVE TENDICINGHIA
CON INSERTI MASCHIO

CONTENUTO:

- TX40, TX45, TX60
- H8, H10



FG 184/FT1 ~~70,00€~~ **39,00€**

CHIAVI PER DADI TENDICINGHIA
FIAT, FORD, CITROEN, PEUGEOT



FG SERVICE 106

KIT PROTEZIONE VEICOLI

~~174,00€~~ **99,00€**

50 COPRISIEDILI IN POLIETILENE DA 20 MICRON

50 TAPPETINI 45X35CM

OLTRE **500 METRI** DI FILM COPRI-VOLANTE

2 MANOPOLE PER BOBINA COPRI-VOLANTE



FG 171/B

PINZA PER RACCORDI
RAPIDI TUBO CARBURANTE

~~36,00€~~ **21,90€**



FG 172/MJ

PINZA PER RACCORDI
RAPIDI TUBO CARBURANTE

Per MULTIJET

~~25,00€~~ **14,90€**





AUTOMOTIVE



FG 215/S40

TESTER PROVA COMPRESSIONE DIGITALE, COMPLETO DI FINTI NIETTORI E FINTE CANDELETTE PER SISTEMI DIESEL

~~1.500,00€~~ 799,00€

MADE IN ITALY



ACCESSORI DI BASE IN DOTAZIONE



PROVA ALTERNATORE
PROVA TENSIONE BATTERIA



PROVA COMPRESSIONE

MADE IN ITALY



FG 219/S

~~3.000,00€~~ 1.799,00€

TESTER MULTI-FUNZIONE PER PROVA COMPRESSIONE E PROVA PRESSIONE CARBURANTI

CARATTERISTICHE TECNICHE:

- grado di precisione: 1%FS
- software in 8 lingue (IT, EN, DE, FR, ES, PT, GR, PL)
- display touch screen LCD retroilluminato a colori, 4.3"
- 2 sensori (0-80Bar e 0.2500Bar)



PROVA ALTERNATORE
PROVA TENSIONE BATTERIA



PROVA COMPRESSIONE



PROVA PRESSIONE CARBURANTE
(ALTA E BASSA)



PROVA OLIO MOTORE

ASTE DI LIVELLO OLIO PER CAMBI AUTOMATICI

CODICE	APPLICAZIONE	LISTINO	€/PROMO
FG 193/DS1	MERCEDES 722.6	35,00	19,90
FG 193/DS2	MERCEDES 722.7, 722.8, 716.S	35,00	19,90



FG 193/ATJ

UTENSILE SMONTAGGIO
TAPPO OLIO CAMBIO
JAGUAR/LAND ROVER

~~45,00€~~ 26,90€



FG 193/MB

UTENSILE PER SCARICO E
MISURAZIONE OLIO CAMBIO
MERCEDES 9G TRONIC

~~65,00€~~ 38,90€



FG 193/S4

KIT ESTRATTORI CUSCINETTI
CAMBI MANUALI GRUPPO VAG

~~590,00€~~ 299,00€



FG 193DSG/S9

SET MONTAGGIO, SMONTAGGIO
E REGISTRAZIONE FRIZIONI
DSG 7 RAPPORTI

~~1.050,00€~~ 599,00€



FG 193/UN

~~980,00€~~ 599,00€

KIT UNIVERSALE PRESSORI PER GRUPPI
FRIZIONE CAMBI AUTOMATICI



FG 194/TS

~~30,00€~~ 17,90€

LEVA PER BLOCCAGGIO/SBLOCCAGGIO
GRUPPO MECCATRONICO FRIZIONE
CAMBIO AUTOMATICO DSG

Gli strumenti migliori, per veri professionisti

La nuova gamma prodotti Fasano Tools dedicata al settore Carrozzeria comprende tutto il necessario per un lavoro altamente professionale.

Utensili performanti e caratterizzati da dettagli votati all'efficienza.

Il nostro vasto e completo assortimento di utensili per carrozzeria è dedicato a lavori di precisione e comprende kit di punzoni, set di raschietti, leve, coltelli, guidafile, impugnature, cunei, levapioli, pinze, leverini, levamolte, ventose, utensili dedicati alla rimozione di scegge ed ogni strumento essenziale per i professionisti del settore.

NUOVI PRODOTTI

SETTORE CARROZZERIA

Alcuni dei nostri nuovi utensili

Scopri tutti nella sezione **AUTOMOTIVE**

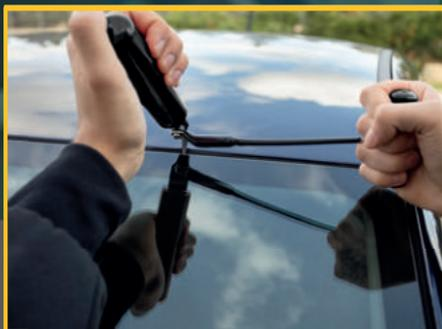

COLTELLO MANUALE DOTATO DI CAVO E SISTEMA FERMA CAVO



UTENSILE RIMOZIONE SCEGGE



RASCHIETTO MANUALE A LAMA DRITTA



UTENSILE RIMOZIONE GUARNIZIONI VETRI



KIT 6 VENTOSE SINGOLE



KIT 4 MINI-VENTOSE PER CRISTALLI AUTO

NEW



FG 130AL/S5

~~35,00€~~

21,00€

KIT PUNZONI IN PLASTICA E BULINO IN ALLUMINIO

CONTENUTO:

01 bulino in alluminio regolabile 70mm-100mm.

Filettatura M8x1.25

04 punzoni in gomma dura resistente agli urti e anti graffio

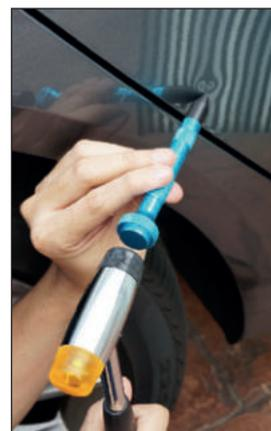

FG 186/S11

SET 11 UTENSILI IN NYLON PER CARROZZERIA

~~115,00€~~

65,00€



NEW



FG 184P/S3

~~25,00€~~

14,90€

SET 3 CUNEI IN PLASTICA

Materiale: Polipropilene ad alta resistenza



NEW

FG 184R/S3

~~45,00€~~

26,90€

SET 3 RASCHIETTI IN ACCIAIO CON MANICO IN ABS

Lunghezza totale: 280mm



FG 184/R1

~~20,00€~~

11,90€

RASCHIETTO IN ACCIAIO CON MANICO IN ABS

Lunghezza totale: 280mm



FG 184/R2

~~22,00€~~

12,90€

RASCHIETTO IN ACCIAIO CON PROTEZIONE IN PVC E MANICO IN ABS

Lunghezza totale: 275mm

NEW



FG 188P/S2

~~40,00€~~

23,90€

KIT CUNEI PER RIMOZIONE MODANATURE IN PLASTICA

Materiale: Polipropilene ad alta resistenza

1pz dotato di manico resistente alle percussioni

1pz senza manico per ideale per spazi ristretti



AUTOMOTIVE



NEW

FG 188/P1

LEVA PER PARTI IN PLASTICA

MATERIALE: Nylon e fibra di vetro
Elevata resistenza alla torsione
Dotate di foro per appendimento

~~18,00€~~ 10,90€



FG 185P/S4

~~25,00€~~ 14,90€

KIT 4 LEVE PER PARTI IN PLASTICA

MATERIALE: Nylon e fibra di vetro
Elevata resistenza alla torsione
Dotate di foro per appendimento



FG 186/S3

SET 3 LEVERINI
IN MATERIALE PLASTICO

~~9,60€~~ 5,90€



FG 186/S3B

SET 3 UNCINI
IN MATERIALE PLASTICO

~~11,20€~~ 6,90€



FG 186P/S5

~~34,00€~~ 18,90€

SET 5 LEVE IN NYLON
RIMOZIONE PIOLI



FG 185/S5

~~95,00€~~ 56,90€

NEW

SET 5 LEVAPIOLI
CON MANICO IN ABS

CONTENUTO: 185/A1, FG 185/A2,
FG 185/A6, FG 185/A7, FG 185/A8



FG 185B/S2

~~40,00€~~ 23,90€

NEW

SET 2 LEVAPIOLI
CON MANICO IN ABS

FG 186/S5

SET 5 LEVE CON LAMA
IN ACCIAIO INOX

~~95,00€~~

54,90€





FG 185/RM

**UTENSILE PER RIMOZIONE MANIGLIA
POGGIA MANO - GRUPPO VAG**

Lunghezza totale: 255mm
Impugnatura in ABS

NEW

~~30,00€~~ **17,90€**



FG 185/CR

UTENSILE LEVA MOLLE A "C"

Ideale per la rimozione delle molle a C presenti sulle manovelle alzacetro

~~10,00€~~ **5,90€**

NEW



NEW



FG 189/P01

~~20,00€~~ **11,90€**

**UTENSILE RIMOZIONE CILINDRETTO
CHIUSURA PORTIERE - GRUPPO VAG**



L/mm

UTENSILE RIMOZIONE SCHEGGE

Ideale per la pulizia del canale alzacetro
Punta sferica per evitare danneggiamenti delle guide portiera

CODICE	L/mm	LISTINO	€/PROMO
FG 182/RG10	255mm	18,00	10,90
FG 182/RG24	320mm	25,00	14,90



NEW



200

FG 183/RV1

~~20,00€~~ **11,90€**

**UTENSILE RIMOZIONE
GUARNIZIONI VETRI**

Lunghezza totale: 252mm
Impugnatura in ABS

NEW



FG 183/RA1

~~25,00€~~ **14,90€**

RASCHIETTO MANUALE A LAMA DRITTA

Fornito con una lama in dotazione
Impugnatura in ABS dotata di foro per di appendamento
Dotato di protezione lama in ABS

NEW



AUTOMOTIVE

NEW



FG 183/CM

COLTELLO MANUALE DOTATO DI CAVO E SISTEMA FERMA CAVO

Impugnatura e cavo rivestito in PVC
Fornito con una lama da 25mm già montata

~~50,00€~~

29,90€

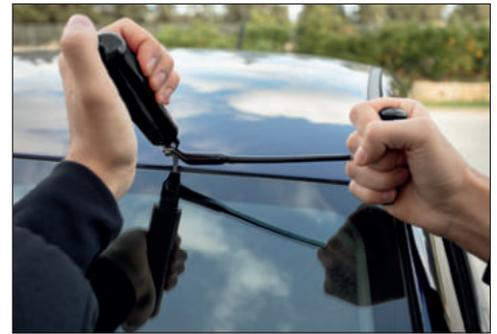

NEW

COLTELLO MANUALE DOTATO DI LAMA INTERCAMBIABILE

Fornito con una lama in dotazione
Impugnatura con rivestimento in PVC
Sistema di bloccaggio lama a vite

CODICE	L/mm	LISTINO	€/PROMO
FG 183/CK250	250mm	21,00	12,90
FG 183/CK450	450mm	32,00	18,90
FG 183/CK600	600mm	40,00	23,90



FG 187/GR

~~28,00€~~

16,90€

UTENSILE UNIVERSALE PER FISSAGGIO GUARNIZIONI

Dotato di 6 accessori
Sistema guida a rullo
Impugnatura in ABS

FG 187/U

LEVA BLOCCAFILO

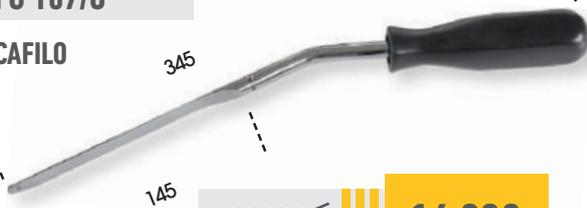

~~28,00€~~

16,90€



FG 187/IM

SET 2 IMPUGNATURE PER CAVO D'ACCIAIO

~~40,00€~~

23,90€

NEW



FG 187/GU2

~~25,00€~~

14,90€

GUIDAFILO A T CON IMPUGNATURA IN ABS

lunghezza 50 m



FG 187/W50

BOBINA DI FILO IN ACCIAIO PER TAGLIO SIGILLANTE
- sezione quadrata

~~34,00€~~

19,90€

lunghezza 22,5 m



NEW

FG 187/WT22.5

~~25,00€~~

14,90€

BOBINA DI FILO IN ACCIAIO PER TAGLIO SIGILLANTE
- sezione triangolare

lunghezza 50 m



NEW

FG 187/NY

~~60,00€~~

35,90€

BOBINA DI FILO IN NYLON
- sezione intrecciata

lunghezza 50 m



NEW

FG 187/IW50

~~30,00€~~

BOBINA DI FILO IN ACCIAIO PER TAGLIO SIGILLANTE
- sezione intrecciata



FG 187/K10 ~~23,00€~~ **13,90€**

KIT 4 MINI-VENTOSE PER CRISTALLI AUTO - capacità 10Kg



FG 187/S7 ~~210,00€~~ **119,00€**

SET 7 UTENSILI PER CRISTALLI AUTO



FG 187/K40 ~~190,00€~~ **109,00€**

VENTOSA SINGOLA DOTATA DI IMPUGNATURA E SISTEMA POMPANTE
- capacità: 40 kg
- diametro: 178mm - 7"

NEW



FG 187K/S6

KIT 6 VENTOSE SINGOLE
- capacità: 10 Kg
- diametro: 78mm - 3"

~~55,00€~~ **32,90€**

NEW

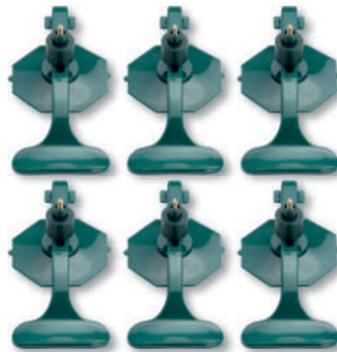

FG 187/PN ~~255,00€~~ **149,00€**

TIRABOLLI PNEUMATICO, COMPLETO DI 3 VENTOSE



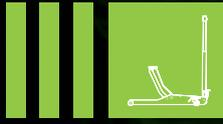

PROFESSIONAL EQUIPMENT

FG 725/...T

COLONNETTE DI SOSTEGNO



CODICE	CAPACITA'	H -MIN/MAX	€/PZ	€/PROMO
FG 725/3T	3 TON	285-425MM	90,00	48,00
FG 725/6T	6 TON	390-605MM	150,00	79,00
FG 725/12T	12 TON	495-720MM	260,00	139,00

FG 735/...T

SOLLEVATORI IDRAULICI A BOTTIGLIA



CODICE	CAPACITA'	H -MIN/MAX	STELO	€/PZ	€/PROMO
FG 735/4T	4 TON	193-373MM	60MM	80,00	42,50
FG 735/6T	6 TON	214-416MM	70MM	93,00	49,00
FG 735/10T	10 TON	230-460MM	80MM	130,00	69,00
FG 735/16T	16 TON	230-440MM	60MM	140,00	79,00
FG 735/20T	20 TON	242-452MM	60MM	192,00	99,00

FG 750/A

CARRELLO MOVIMENTAZIONE VEICOLI
- CAPACITÀ 680KG

~~390,00€~~ **208,00€**

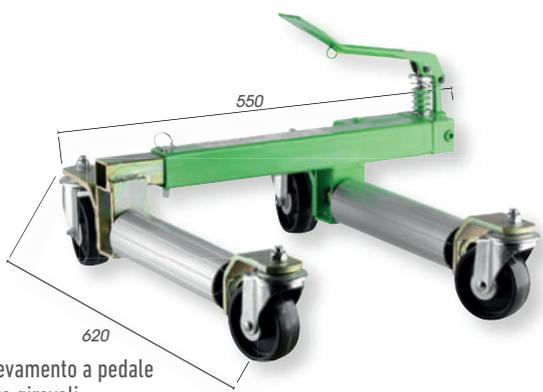

- Sistema di sollevamento a pedale
- Dotato di 4 ruote girevoli

FG 748/0.5T

SUPPORTO SOSTEGNO MOTORE
- CAPACITÀ 500KG

~~240,00€~~ **128,00€**

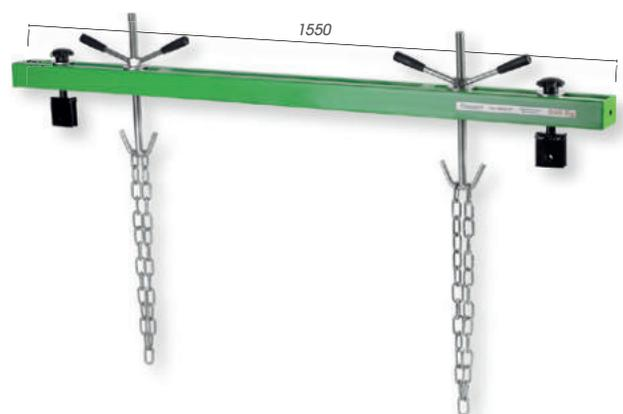

GUARDA IL VIDEO



MADE IN ITALY



SICUREZZA TOTALE

Display digitale in grado di misurare la forza di compressione applicata



AFFIDABILITA'

Le griffe sono prodotte in acciaio forgiato e sono dotate di un incavo profondo per garantire una presa totale della molla senza rischi di alcun genere per l'utilizzatore



VELOCITA' D'USO

Lo speciale sistema autocentrante permette di posizionare i bracci con una sola mano e in modo rapido



PRECISIONE

La base d'appoggio inferiore, ottenuta in materiale gommoso, è dotata di bloccaggio a volantino e permette un posizionamento preciso dell'ammortizzatore



FG 750/1P

SMONTA AMMORTIZZATORI DOTATO DI 1 PISTONE

Potenza spinta:
1.2 ton (10 bar)
- 0.9 ton (8 bar)
Corsa di compressione molla: 300mm

~~2.400,00€~~ **1.249,00€**



FG 750/2P

SMONTA AMMORTIZZATORI DOTATO DI 2 PISTONI

Potenza spinta:
2.4 ton (10 bar)
- 1.9 ton (8 bar)
Corsa di compressione molla: 300mm

~~3.100,00€~~ **1.549,00€**



FG 752/1P

SMONTA AMMORTIZZATORI DOTATO DI 1 PISTONE E DISPLAY DIGITALE

Il display digitale visualizza la pressione applicata durante la fase di utilizzo

~~3.200,00€~~ **1.549,00€**



FG 752/2P

SMONTA AMMORTIZZATORI DOTATO DI 2 PISTONI E DISPLAY DIGITALE

Il display digitale visualizza la pressione applicata durante la fase di utilizzo

~~3.800,00€~~ **1.799,00€**



PROFESSIONAL EQUIPMENT

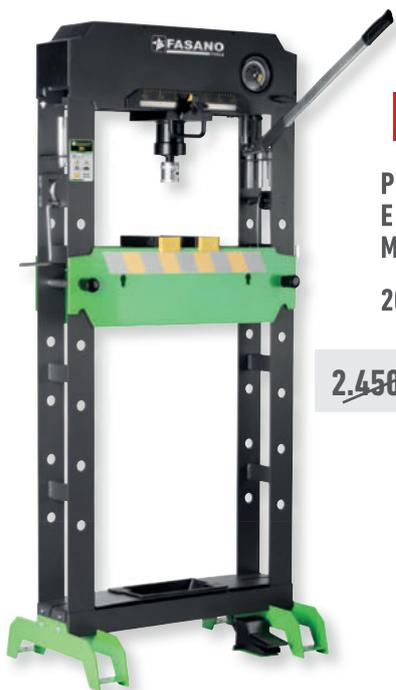

FG 732/20TP

**PRESSA IDRAULICA MANUALE
E PNEUMATICA CON PISTONE
MOBILE E ARGANO**

20 TON

~~2.450,00€~~

1.249,00€

CE



Serie di cacciaspine
in dotazione



Coperture anti
polvere rimovibili



Manometro di facile
lettura, integrato



Sistema di
regolazione ad argano



Speciale design per una
maggiore regolabilità
della base



Base d'appoggio rinforzata e
dotata di contenitore
porta minuterie



Piastre a V, regolabili a 180°



Pistone mobile, con
scala di misurazione

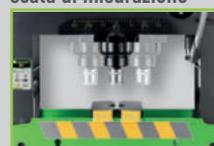

FG 740/0.5T

~~600,00€~~

299,00€

**SOLLEVATORE IDRAULICO DA FOSSA E SOTTOPONTE
- CAPACITÀ 500KG**

- Sistema di sollevamento a pedale
- Dotato di 4 ruote girevoli

CE



FG 738/1T

~~1.100,00€~~

549,00€

**GRU IDRAULICA PIEGHEVOLE
CON POMPA A DOPPIO EFFETTO**

- Capacità: 1 Ton
- Versione richiudibile
- Dotata di pompa a doppio effetto
- Ruote in acciaio per una maggiore durata e portata

CE

Sistema di rotazione a 360° a manovella



FG 745/CMR

CAVALLETTO SOSTEGNO MOTORE RICHIUDIBILE

- Versione richiudibile
- Possibilità di rotazione a 360°
- Ruote in acciaio per una maggiore durata e portata

~~950,00€~~

499,00€

CE

Sistema di rotazione a 360°



FG 745/CMF

CAVALLETTO SOSTEGNO MOTORE

- Possibilità di rotazione a 360°
- Ruote in acciaio per una maggiore durata e portata

~~420,00€~~

229,00€

FG 722/5T

SOLLEVATORE IDRAULICO A CARRELLO 5 TON - MODELLO LUNGO PER MEZZI PESANTI

~~1.370,00€~~

749,00€

Sistema di sollevamento ausiliario a pedale



Ruote in acciaio montate su cuscinetti a sfera

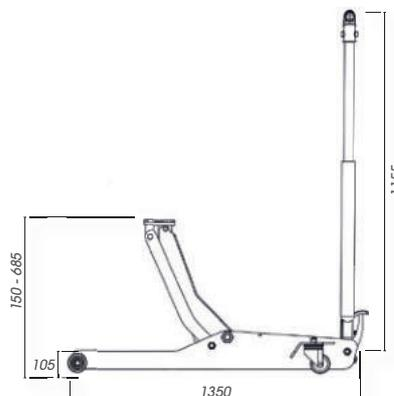



PROFESSIONAL EQUIPMENT

FG 710/A



LETTINO SOTTO MACCHINA
IN PLASTICA ANTI-URTO
Dimensioni: 1.020x450x90mm

KG
136 PORTATA
STATICA

~~85,00€~~ **45,00€**

FG 710/B



LETTINO SOTTO
MACCHINA RICHIUDIBILE
Dimensioni da aperto: 910x415x120mm
Dimensioni da chiuso: 540x415x150mm

KG
136 PORTATA
STATICA

~~110,00€~~ **58,00€**

FG 710/C

SEGGIOLINO GIREVOLE,
DOTATO DI ACCESSORI

~~150,00€~~ **79,00€**



FG 710/D

SEGGIOLINO GIREVOLE,
DOTATO DI ACCESSORI

~~245,00€~~ **129,00€**



FG 712/A

PORTA MINUTERIE/UTENSILI
DOTATO DI RUOTE GIREVOLI

- Dotato di 2 scomparti magnetici porta minuterie
- Dotato di 2 ampi scomparti porta utensili
- Dotato di piastra centrale magnetica
- 3 ruote girevoli da 500mm
- Materiale: ABS resistente agli urti

~~78,00€~~ **36,90€**



La Rete virtuale

Comunichiamo online la nostra passione

Abitiamo la Rete del worldwide web con creatività, comunicando tutta la passione che mettiamo nel nostro lavoro, ma anche i progetti futuri, le novità e le collaborazioni.

fasanotools.com

Il nostro sito web è costantemente aggiornato ed è un importante punto di riferimento per clienti e rivenditori che, personalizzano la propria esperienza virtuale, accedendovi tramite area riservata. Il portale propone l'intero catalogo delle nostre referenze, i promozionali, i servizi nel dettaglio, i nuovi prodotti ed i contatti.

Ogni utensile è corredato da informazioni precise, schede tecniche ed elenco dei relativi ricambi disponibili.

Inoltre grazie all'innovativo strumento **TOOL FINDER**, gli utenti del settore Automotive hanno la possibilità di cercare, in maniera semplice e veloce, il kit di Fasatura Motore necessario, in base al veicolo.

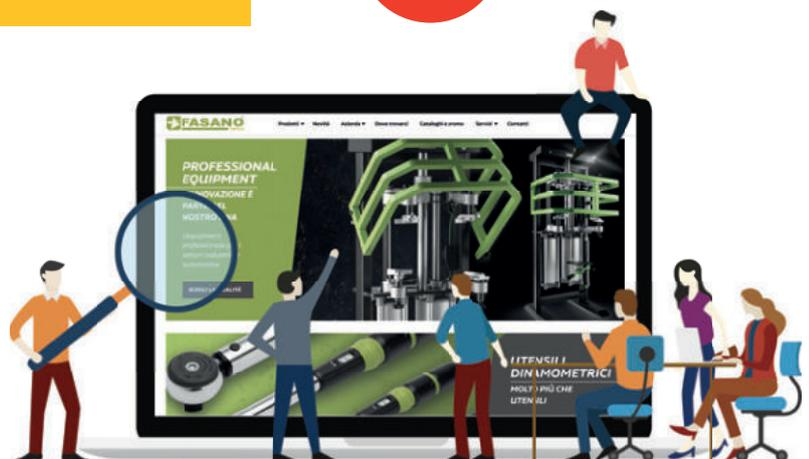

La nostra presenza sui **Social Media** si propone di instaurare un rapporto di fiducia con il nostro pubblico, basato sulla trasparenza e la sua stessa partecipazione alle nostre attività. In particolare, su **Facebook** coinvolgiamo i nostri utenti, clienti e appassionati di settore, con informazioni, video, immagini e contest dedicati.

Il nostro canale **Youtube** si popola di giorno in giorno con video dimostrativi, di approfondimento o relativi alle nostre partecipazioni ad eventi. Utilizziamo il nostro canale **Linkedin** per comunicare contenuti specifici ad esperti e professionisti del settore. Su **Instagram**, infine, comunichiamo la nostra realtà giornalmente, mostrando i retroscena della progettazione, dei processi creativi, come i nuovi prodotti ubicati nel contesto di riferimento.

Su questo canale mondiale, l'**hashtag #fasanotools** dá voce anche ai nostri clienti e partner, mostrando tutte le sfumature di una grande realtà quale è Fasano Tools.

RIMANI AGGIORNATO

SEGUICI SUI CANALI SOCIAL



ISCRIVITI ALLA NEWSLETTER

WWW.FASANOTOOLS.COM

INDICE

CODICE	PAGINA	€/Promo
FG 22/S10	16	34,90
FG 22/S12	16	48,90
FG 22/S6	16	19,90
FG 22/S8	16	25,90
FG 22/S8B	16	28,90
FG 22E/S6	20	31,90
FG 22E/SZ6	20	31,90
FG 22TX/LS11	17	89,90
FG 22TX/S6	16	35,90
FG 22XL/S8	17	49,90
FG 43/MT3	26	3,80
FG 43/MT5	26	4,80
FG 44/MT10	26	15,90
FG 44/MT3	26	5,90
FG 44/MT5	26	9,50
FG 44/MT8	26	13,50
FG 47/S3	29	33,90
FG 47/S4	29	12,90
FG 49/HE200	25	12,50
FG 49/HE250	25	14,50
FG 49/HE300	25	18,50
FG 49/HE350	25	23,50
FG 49/L	25	9,50
FG 49/TC	25	21,90
FG 49/TCX	25	27,90
FG 50/ME	25	22,90
FG 51/S4B	19	55,00
FG 56/S3	19	49,90
FG 57/S3	19	65,00
FG 59IS/S3	20	59,90
FG 59PV/S3	19	37,90
FG 66/TF220	19	59,90
FG 67/350	25	28,90
FG 67/450	25	36,90
FG 67/600	25	49,90
FG 67/750	25	63,90
FG 67/900	25	79,90
FG 68/CC	20	89,00
FG 68/CR	20	99,00
FG 68/CS1	21	9,50
FG 68/CS2	21	10,90
FG 68/CS6	21	14,90
FG 68/SP1	21	9,90
FG 68/SP2	21	8,50
FG 70/S110	24	189,00
FG 75CO/S25	24	129,00
FG 75TIN/S25	24	109,00
FG 81HSS/S3	24	139,00
FG 84F/S6	21	16,90
FG 84TX/S6	21	18,90
FG 85/S11	18	16,90
FG 85/S15L	18	49,90
FG 85TX/S11	18	17,90
FG 92/PF	27	12,90
FG 92/PM	27	10,90
FG 93/M95	29	17,90
FG 93/P	29	1,90
FG 94/MI	58	21,90
FG 94/MS	58	15,90
FG 94/R	58	11,90
FG 94/T	58	9,90
FG 95/CA	26	26,90

CODICE	PAGINA	€/Promo
FG 95/DG	26	49,90
FG 95/M1	26	29,90
FG 95/M2	26	32,90
FG 95/M3	26	39,90
FG 95/M4	26	44,90
FG 96/DG	21	99,00
FG 96/SS36	28	36,90
FG 98/GAS	28	69,00
FG 98/LT	28	149,00
FG 98/PC8	28	19,90
FG 98/ST8	28	19,90
FG 99	97	289,00
FG 99/B	97	355,00
FG 99/C	97	999,00
FG 100/03E	76	49,90
FG 100/03F	76	53,90
FG 100/03G	76	79,90
FG 100/03L	76	85,00
FG 100/07C	76	56,90
FG 100/08C	76	139,00
FG 100/10C	76	189,00
FG 100/10D	76	279,00
FG 100/17	76	75,00
FG 100/17E	76	159,00
FG 100/21B	77	135,00
FG 100/21C	77	135,00
FG 100/21D	77	95,00
FG 100/21H	77	239,00
FG 100/21M	77	95,00
FG 100/21TX	77	145,00
FG 100/23C	77	129,00
FG 100/25	77	239,00
FG 100/25B	77	239,00
FG 100/39C	77	52,90
FG 100/41C	77	63,90
FG 100/42C	77	66,90
FG 100/45D	78	33,90
FG 100/45E	78	39,90
FG 100/45H	78	44,90
FG 100/45I	78	42,90
FG 100/45T	78	44,90
FG 100/48G	78	75,00
FG 100/51H	78	75,00
FG 100/54	78	79,90
FG 100/56C	78	72,50
FG 100/65B	77	39,90
FG 100/81F	77	159,00
FG 100/VA1	78	13,90
FG 100B/5T	56	519,00
FG 100B/6T	56	539,00
FG 100B/7T	56	559,00
FG 100B/AS192	62	999,00
FG 100B/AS226	69	1.149,00
FG 100B/AS228	71	1.299,00
FG 100B/AS229	63	1.099,00
FG 100B/AS56	75	1.299,00
FG 100R/5T	56	519,00
FG 100R/6T	56	539,00
FG 100R/7T	56	559,00
FG 100R/AS192	62	999,00
FG 100R/AS226	69	1.149,00

CODICE	PAGINA	€/Promo
FG 100R/AS228	71	1.299,00
FG 100R/AS229	63	1.099,00
FG 100R/AS56	75	1.299,00
FG 100V/5T	56	519,00
FG 100V/6T	56	539,00
FG 100V/7T	56	559,00
FG 100V/AS192	62	999,00
FG 100V/AS226	69	1.149,00
FG 100V/AS228	71	1.299,00
FG 100V/AS229	63	1.099,00
FG 100V/AS56	75	1.299,00
FG 101V/5G	55	359,00
FG 101V/6G	55	379,00
FG 101V/7G	55	399,00
FG 101V/AS136	59	699,00
FG 101V/AS182	60	799,00
FG 102/03E	64	43,90
FG 102/03F	64	49,90
FG 102/03G	64	74,90
FG 102/03H	64	139,00
FG 102/03L	64	79,00
FG 102/07C	64	52,90
FG 102/07D	64	75,00
FG 102/08C	64	129,00
FG 102/10C	64	179,00
FG 102/13C	64	99,00
FG 102/17	64	64,90
FG 102/17E	64	149,00
FG 102/19	65	115,00
FG 102/19B	65	105,00
FG 102/21B	65	129,00
FG 102/21C	65	129,00
FG 102/21D	65	89,00
FG 102/21E	65	89,00
FG 102/21H	65	115,00
FG 102/21R	65	129,00
FG 102/21TX	65	129,00
FG 102/23C	65	69,00
FG 102/25	65	209,00
FG 102/25B	65	209,00
FG 102/39C	65	46,90
FG 102/39D	65	39,90
FG 102/41C	66	52,90
FG 102/42C	66	59,90
FG 102/45D	66	25,90
FG 102/45E	66	32,90
FG 102/45F	66	29,90
FG 102/45G	66	27,90
FG 102/45I	66	34,90
FG 102/45L	66	36,90
FG 102/45T	66	37,90
FG 102/45U	66	49,90
FG 102/48D	67	49,90
FG 102/48G	67	69,90
FG 102/50F	67	42,90
FG 102/50G	67	42,90
FG 102/51H	65	64,90
FG 102/56C	67	64,90
FG 102/60C	67	23,90
FG 102/62B	67	44,90
FG 102/62C	67	44,90
FG 102/65B	67	35,90

CODICE	PAGINA	€/Promo
FG 102/VA1	67	8,90
FG 102B/5G	55	469,00
FG 102B/6G	55	499,00
FG 102B/7G	55	529,00
FG 102B/8G	55	559,00
FG 102B/AS158	61	999,00
FG 102B/AS205	68	999,00
FG 102D/5G	55	469,00
FG 102D/6G	55	499,00
FG 102D/7G	55	529,00
FG 102D/8G	55	559,00
FG 102D/AS158	61	999,00
FG 102D/AS205	68	999,00
FG 102R/5G	55	469,00
FG 102R/6G	55	499,00
FG 102R/7G	55	529,00
FG 102R/8G	55	559,00
FG 102R/AS158	61	999,00
FG 102R/AS205	68	999,00
FG 102V/5G	55	469,00
FG 102V/6G	55	499,00
FG 102V/7G	55	529,00
FG 102V/8G	55	559,00
FG 102V/AS158	61	999,00
FG 102V/AS205	68	999,00
FG 104B/6G	56	579,00
FG 104B/7G	56	599,00
FG 104B/AS242	72	1.499,00
FG 104D/6G	56	579,00
FG 104D/7G	56	599,00
FG 104D/AS242	72	1.499,00
FG 104R/6G	56	579,00
FG 104R/7G	56	599,00
FG 104R/AS242	72	1.499,00
FG 104V/6G	56	579,00
FG 104V/7G	56	599,00
FG 104V/AS242	72	1.499,00
FG 105B/5G	57	689,00
FG 105B/6G	57	719,00
FG 105B/7G	57	759,00
FG 105D/5G	57	689,00
FG 105D/6G	57	719,00
FG 105D/7G	57	759,00
FG 105R/5G	57	689,00
FG 105R/6G	57	719,00
FG 105R/7G	57	759,00
FG 105V/5G	57	689,00
FG 105V/6G	57	719,00
FG 105V/7G	57	759,00
FG 106/B	79	169,00
FG 106/C	79	199,00
FG 107/A	79	99,00
FG 109B/6G	57	799,00
FG 109B/7G	57	849,00
FG 109D/6G	57	799,00
FG 109D/7G	57	849,00
FG 109R/6G	57	799,00
FG 109R/7G	57	849,00
FG 109V/6G	57	799,00
FG 109V/7G	57	849,00
FG 111/A	36	31,90
FG 111/AS104	37	299,00

CODICE	PAGINA	€/Promo
FG 111/AS55	37	219,00
FG 111/B	36	37,90
FG 111/C	36	42,90
FG 114/L2	36	34,90
FG 115/A	38	128,00
FG 117/A	38	209,00
FG 118/AS56	39	379,00
FG 118/AS75	39	299,00
FG 118/CO20B	87	7.599,00
FG 118/CO20R	87	7.599,00
FG 118/CO20V	87	7.599,00
FG 118/CO2B	85	2.999,00
FG 118/CO2R	85	2.999,00
FG 118/CO2V	85	2.999,00
FG 118/CO5B	86	3.799,00
FG 118/CO5R	86	3.799,00
FG 118/CO5V	86	3.799,00
FG 118/CO8B	86	1.999,00
FG 118/CO8R	86	1.999,00
FG 118/CO8V	86	1.999,00
FG 118/CO13B	85	2.849,00
FG 118/CO13R	85	2.849,00
FG 118/CO13V	85	2.849,00
FG 119B/CO11	43	1.899,00
FG 119B/CO14	42	1.699,00
FG 119B/CO21	43	2.299,00
FG 119B/CO23	42	1.999,00
FG 119B/CO3	42	1.149,00
FG 119B/CO31	43	2.999,00
FG 119R/CO11	43	1.899,00
FG 119R/CO14	42	1.699,00
FG 119R/CO21	43	2.299,00
FG 119R/CO23	42	1.999,00
FG 119R/CO3	42	1.149,00
FG 119R/CO31	43	2.999,00
FG 119V/CO11	43	1.899,00
FG 119V/CO14	42	1.699,00
FG 119V/CO21	43	2.299,00
FG 119V/CO23	42	1.999,00
FG 119V/CO3	42	1.149,00
FG 119V/CO31	43	2.999,00
FG 125/S3	29	39,00
FG 127/S1	27	25,90
FG 128C/S6	27	24,50
FG 129/B2	80	539,00
FG 129/BR1	80	85,00
FG 129/BR1.5	80	119,00
FG 129/D2	80	539,00
FG 129/GR1	80	85,00
FG 129/GR1.5	80	119,00
FG 129/LB2	81	499,00
FG 129/LD2	81	499,00
FG 129/LR2	81	499,00
FG 129/R2	80	539,00
FG 129/RR1	80	85,00
FG 129/RR1.5	80	119,00
FG 130AL/S5	103	21,00
FG 131/A1	83	699,00
FG 131/B2	82	899,00
FG 131/D1	83	549,00
FG 131/D2	82	899,00
FG 131/FB2	81	859,00

CODICE	PAGINA	€/Promo
FG 131/FD2	81	859,00
FG 131/FR2	81	859,00
FG 131/R2	82	899,00
FG 132/B2	82	1.249,00
FG 132/D2	82	1.249,00
FG 132/R2	82	1.249,00
FG 137/B1.5	83	699,00
FG 137/D1.5	83	699,00
FG 137/R1.5	83	699,00
FG 138	18	29,90
FG 138/BP	18	31,90
FG 138/M	18	33,90
FG 139	17	18,90
FG 139/B	17	8,90
FG 139/C	17	11,90
FG 139/D	17	10,90
FG 139/E	17	17,90
FG 139/L	17	21,90
FG 139/LM	18	27,90
FG 139/S9	17	19,90
FG 1425	35	54,00
FG 1426	35	64,00
FG 1427	35	90,00
FG 1434	35	76,50
FG 1438/S4	35	335,00
FG 1438/S4B	35	359,00
FG 1440	36	29,90
FG 1445	36	26,90
FG 150D/AS167	70	1.249,00
FG 150R/AS167	70	1.249,00
FG 150H/S30	14	119,00
FG 150M/S26	14	99,00
FG 150TX/S32	14	109,00
FG 152/RTXS10	15	95,00
FG 152RH/S9	15	69,00
FG 159/PM	96	119,00
FG 160B/14L	58	1.799,00
FG 160B/AS292	73	2.899,00
FG 160D/14L	58	1.799,00
FG 160D/AS292	73	2.899,00
FG 160R/14L	58	1.799,00
FG 160R/AS292	73	2.899,00
FG 160V/14L	58	1.799,00
FG 160V/AS292	73	2.899,00
FG 162/FR1	45	89,00
FG 162/FR2	45	115,00
FG 162/FR3	45	139,00
FG 162/ME	45	17,90
FG 162/S3	44	199,00
FG 163/S2B	44	139,00
FG 164/S3	95	129,00
FG 164/S3B	95	89,00
FG 165/1	45	165,00
FG 165/2	45	199,00
FG 165/3	45	309,00
FG 165/FC	96	24,90
FG 165/GO1	96	99,00
FG 166/LT	97	379,00
FG 166/LT2	97	439,00
FG 168/EF1	44	179,00
FG 168/EF2	44	189,00
FG 168/S25	45	79,00

CODICE	PAGINA	€/Promo
FG 169/1	96	34,90
FG 169/2	96	44,90
FG 169/A44	96	29,90
FG 171/B	99	21,90
FG 172/AS2	98	62,90
FG 172/AS2-A	98	14,90
FG 172/AS2-B	98	29,90
FG 172/AS2-C	98	17,90
FG 172/AS2-D	98	19,90
FG 172/FA	98	39,90
FG 172/MJ	99	14,90
FG 172/TC	98	29,90
FG 172/TG	98	19,90
FG 174/F2	92	42,50
FG 175/FO74	88	24,90
FG 175/FO74.5	88	24,90
FG 175/FO84	88	32,90
FG 175/FT1	92	39,00
FG 175/FT2	92	49,00
FG 175/FT3	92	49,00
FG 175/FT4	92	42,50
FG 175/FT5	92	42,50
FG 175/Hi	88	34,90
FG 175/PO	89	7,90
FG 175/PO1	89	6,90
FG 175/PO2	89	7,90
FG 175/PO3	89	6,90
FG 175/S15	89	79,00
FG 175/S30	89	115,00
FG 175/S4	89	34,90
FG 175/S6	89	34,90
FG 176/FO1	88	49,90
FG 176/FO2	88	52,90
FG 176/FP	88	24,90
FG 176/FP2	88	26,90
FG 176/S13	90	252,00
FG 178/BF	94	149,00
FG 178/S6	94	189,00
FG 178/SF	94	849,00
FG 178SF/AD13	94	31,90
FG 178SF/AD14	94	31,90
FG 179/S16	93	82,50
FG 180/SP6	5	69,00
FG 182/RG10	105	10,90
FG 182/RG24	105	14,90
FG 182/S14	45	129,00
FG 182/S16	93	259,00
FG 183/CK250	106	12,90
FG 183/CK450	106	18,90
FG 183/CK600	106	23,90
FG 183/CM	106	29,90
FG 183/RA1	105	14,90
FG 183/RV1	105	11,90
FG 184/FT1	99	39,00
FG 184/R1	103	11,90
FG 184/R2	103	12,90
FG 184/S24	98	239,00
FG 184/S5	99	85,00
FG 184/S6	99	49,00
FG 184P/S3	103	14,90
FG 184R/S3	103	26,90
FG 185/CR	105	5,90

CODICE	PAGINA	€/Promo
FG 185/RM	105	17,90
FG 185/S5	104	56,90
FG 185B/S2	104	23,90
FG 185P/S4	104	14,90
FG 186/S11	103	65,00
FG 186/S3	104	5,90
FG 186/S3B	104	6,90
FG 186/S5	104	54,90
FG 186P/S5	104	18,90
FG 187/GR	106	16,90
FG 187/GU	106	16,90
FG 187/GU2	106	14,90
FG 187/IM	106	23,90
FG 187/IW50	106	17,90
FG 187/K10	107	13,90
FG 187/K40	107	109,00
FG 187/NY	106	35,90
FG 187/PN	107	149,00
FG 187/S7	107	119,00
FG 187/W50	106	19,90
FG 187/WT22.5	106	14,90
FG 187K/S6	107	32,90
FG 188/P1	104	10,90
FG 188P/S2	103	23,90
FG 189/PO1	105	11,90
FG 190/AD1	91	29,90
FG 190/AD2	91	19,90
FG 190/RI	91	33,90
FG 190/S6B	91	89,00
FG 191/S22	91	349,00
FG 193/ATJ	101	26,90
FG 193/DS1	101	19,90
FG 193/DS2	101	19,90
FG 193/MB	101	38,90
FG 193/S4	101	299,00
FG 193/UN	101	599,00
FG 193DSG/S9	101	599,00
FG 194/TS	101	17,90
FG 198/DG	96	19,90
FG 199/FM	96	17,90
FG 199/PF	95	119,00
FG 199/SF	94	36,00
FG 201/CR	91	139,00
FG 202/PV	90	119,00
FG 203/A	90	9,90
FG 203/BW1	90	21,00
FG 203/FO1	90	21,00
FG 203/FO2	90	21,00
FG 203/OP1	90	21,00
FG 203/S20	90	199,00
FG 203/S7	90	95,00
FG 203/TO1	90	21,00
FG 204	30	17,90
FG 206	30	27,90
FG 207	31	32,90
FG 208	31	139,00
FG 210/A	31	49,90
FG 211	32	59,00
FG 212	32	39,00
FG 212	32	39,00
FG 213/L480	33	39,00

DISTRIBUTORE UFFICIALE



FASANOTOOLS.COM



VALIDITA' 1/03/2022 - 15/01/2023