

MARCO  
**TOOLS**  
BY SPIN



# PROMO 2022/2

VALIDITÀ • VALIDITY • VALIDEZ 01/10/2022 - 31/03/2023



AUTOATTREZZATURE PROFESSIONALI

PROFESSIONAL GARAGE EQUIPMENT

Cod.	Promo, €	Pag.	Cod.	Promo, €	Pag.	Cod.	Promo, €	Pag.	Cod.	Promo, €	Pag.
01.000.01	4,20	74	01.017.05	939,00	73	03.024.40	690,00	40	05.056.03	19,00	110
01.000.08	54,00	72	01.017.06	805,00	73	03.024.41	750,00	40	05.056.07	64,00	110
01.000.08IMP	28,70	72	01.090.00	63,00	73	03.031.01	128,00	95	05.056.08	9,90	108
01.000.37	8,40	74	01.090.01	325,00	73	03.031.16	109,00	95	05.056.09	48,00	110
01.000.39	18,90	74	01.090.04	63,00	73	03.031.32LT	728,00	44	05.056.12	41,00	108
01.000.100	78,60	72	01.090.08	246,00	71	03.031.33	178,00	44	05.056.16	27,93	111
01.000.124	29,90	74	01.090.10	76,00	73	03.031.36	26,00	44	05.056.20	3,90	109
01.000.125	29,50	74	01.090.11	18,00	73	03.032.01	770,00	137	05.058.01	86,60	109
01.000.127	38,50	74	01.090.12	95,00	73	03.036.01	1.141,00	43	05.058.07	26,95	109
01.000.167	p.a.r.	74	01.090.13	47,60	72	03.036.04	15,00	105	05.058.08	10,50	109
01.000.168	65,00	72	01.090.15	238,00	72	03.036.17	165,00	69	05.058.09	25,20	109
01.000.168IMP	34,30	72	01.090.16	360,00	72	03.036.25	21,00	112	05.060.00	29,90	149
01.000.187	p.a.r.	74	02.000.101	11,00	68	03.036.26	119,00	43	05.060.02	18,50	66
01.000.203.R1	70,00	72	02.000.43	42,00	68	03.036.28	148,00	107	05.060.03	26,00	66
01.000.203M	181,00	72	02.000.96	99,00	69	03.036.35	770,00	106	05.060.04J	104,00	66
01.000.207	5,00	74	02.009.13	139,00	68	03.036.36	210,00	29	05.062.00	70,00	105
01.000.208	9,90	74	02.009.15	109,50	68	03.036.38	269,00	43	05.062.00.R1	21,00	105
01.000.214	182,00	73	02.009.16	233,00	68	03.036.39	43,00	107	05.062.01	33,50	112
01.000.215	84,30	81	02.009.17	283,00	68	03.036.40	43,00	107	05.062.02	13,20	105
01.000.215W	86,50	81	02.009.18	4.800,00	69	03.050.00	36,00	65	05.062.03	13,90	135
01.000.224	162,00	81	02.009.19	5.500,00	69	03.050.06	420,00	65	05.062.04	14,00	135
01.000.224L	203,00	81	02.009.22	1.750,00	69	04.003.12	198,00	50	05.062.05	11,90	110
01.000.225	427,00	71	02.009.23	3.800,00	69	04.003.13	82,60	50	05.062.06	15,00	117
01.000.241	29,50	74	02.009.24	445,00	68	04.003.14	260,00	50	05.064.00	84,00	135
01.000.242	27,50	74	02.009.25	639,00	68	04.013.05	38,40	67	05.066.02	56,00	136
01.000.252	20,90	74	02.016.04	79,00	113	04.014.01	99,00	67	05.066.06PRO	449,00	138
01.000.253	23,90	74	02.020.05	290,00	113	04.014.02	349,00	141	05.066.11	p.a.r.	139
01.000.254	22,00	74	02.022.113	166,00	111	04.014.03	1.299,00	91	05.066.13	p.a.r.	139
01.000.255	22,70	74	02.022.91	15,40	105	04.018.05	321,00	140	05.066.27	p.a.r.	139
01.000.257	262,00	81	03.000.35	10,50	95	04.018.06	65,00	140	05.066.28	p.a.r.	139
01.000.258	156,00	142	03.000.36	11,40	95	04.019.02	576,00	140	05.067.01	39,00	112
01.000.260	548,00	144	03.000.38	337,00	96	04.024.01	119,00	114	05.073.21	4,50	149
01.000.261	10,00	144	03.000.40	425,00	96	04.024.02	175,00	114	05.073.22	4,98	149
01.000.269	115,00	81	03.000.42	79,00	149	04.029.01	38,00	115	05.073.24T	22,50	58
01.000.276	13,00	86	03.000.45	59,00	96	04.042.00	20,30	135	05.073.24TK	64,50	58
01.000.278	34,00	77	03.000.47	9,90	98	04.042.01	20,30	135	05.073.25T	42,00	58
01.000.279	1,95*	76	03.000.49	29,00	153	04.043.00	70,00	115	05.073.25TK	84,00	58
01.000.280	31,50	85	03.000.50	2.590,00	99	04.043.01	24,00	115	05.073.26	94,00	56
01.000.281	159,00	77	03.000.51	2.990,00	99	04.051.00	46,00	143	05.073.28	17,90	59
01.000.282	12,95	87	03.000.52	96,00	97	04.051.01	52,00	143	05.073.29	21,00	59
01.000.283E	282,00	78	03.001.06	990,00	95	04.051.02NEW	239,00	143	05.073.30	40,90	60
01.000.284	12,29	87	03.015.00	252,00	34	04.052.00	8,50	67	05.073.35	99,00	47
01.000.286	145,00	79	03.015.03	172,00	37	04.052.02	17,50	141	05.073.38	47,50	64
01.000.286.R2	32,00	79	03.015.04	379,00	37	04.052.03	21,00	141	05.073.39	34,00	62
01.000.294	15,57	87	03.015.11	559,00	35	04.052.04	23,10	141	05.073.40	31,00	61
01.000.295	195,00*	88	03.016.02	319,00	35	04.052.05	42,00	141	05.073.42	52,00	47
01.000.296	68,00	88	03.017.01	328,00	37	04.052.06	75,00	89	05.073.43	87,00	47
01.000.297	47,00	79	03.018.01	896,00	34	04.052.07	36,00	142	05.073.44	53,00	47
01.000.299	p.a.r.	80	03.019.02	1.050,00	36	04.053.00	49,80	116	05.073.45	72,00	47
01.000.300	327,00	82	03.020.10	429,00	34	04.053.01	72,00	116	05.073.46	12,50	64
01.000.300.R1	10,00	82	03.024.20	495,00	51	04.053.05	350,00	116	05.073.47	62,00	63
01.000.300.R2	40,00	82	03.024.22	1.140,00	54	04.053.07	39,00	116	05.073.48	29,90	84
01.000.306	49,00	78	03.024.30	46,00	53	04.053.08	145,00	115	05.073.49	38,00	63
01.000.308	435,00	76	03.024.31	65,90	53	04.053.09	35,00	115	05.073.51	32,00	58
01.000.309	66,50	76	03.024.32	95,60	53	05.008.01	6,50	135	05.073.52	28,60	60
01.000.310	550,00	70	03.024.33	59,90	53	05.013.03	5,95	135	05.074.05	120,00	136
01.000.311	172,00	71	03.024.34	34,90	55	05.013.04	28,00	66	05.075.10	382,00	48
01.000.319	10,80	73	03.024.37	78,00	55	05.019.03	130,00	108	05.075.11	4,80	49
01.000.320	12,80	73	03.024.38	322,00	42	05.036.04	249,00	107	05.075.12	31,00	49

Cod.	Promo, €	Pag.	Cod.	Promo, €	Pag.	Cod.	Promo, €	Pag.	Cod.	Promo, €	Pag.
05.075.13	19,00	49	05.086.00	159,00	127	05.088.146	734,00	6	05.090.43	19,55	9
05.075.14	52,00	49	05.086.05	109,00	127	05.088.147	169,00	13	05.090.44	16,50	9
05.075.15	52,00	49	05.086.11	26,00	127	05.088.148	320,00	131	05.090.47	130,00	114
05.075.16	1.290,00	48	05.086.12	45,00	127	05.088.149	189,00	22	05.090.48	34,00	126
05.075.17	422,00	49	05.086.14	102,00	128	05.088.150	499,00	12	05.090.49	136,00	123
05.075.18	p.a.r.	49	05.086.15	122,00	128	05.088.25	43,00	15	05.090.52	98,00	125
05.075.22	11,00	49	05.086.16	152,00	128	05.088.30	110,00	11	05.090.54	30,90	103
05.075.23	38,00	49	05.087.02	159,00	134	05.088.40	179,00	13	05.090.55	30,90	103
05.075.24	4,60	49	05.087.04	130,00	120	05.088.47	380,00	7	05.090.56	30,90	103
05.075.25	14,00	49	05.087.06	115,00	46	05.088.48	223,95	7	05.090.57	30,90	103
05.075.26	4,60	49	05.087.07	305,00	131	05.088.55T	319,00	6	05.090.58	30,00	103
05.075.27	56,00	49	05.087.10	38,50	134	05.088.55X	319,00	6	05.090.61	34,00	103
05.075.28	13,50	49	05.087.13	96,00	128	05.088.56X	542,00	6	05.090.62	30,00	122
05.075.29	13,50	49	05.087.16	210,00	120	05.088.58	175,00	98	05.090.63	28,50	122
05.075.30	152,00	48	05.088.02	62,00	15	05.088.60	88,00	150	05.090.64	69,00	122
05.075.31.R1	p.a.r.	48	05.088.03	33,00	15	05.088.67	27,90	150	05.090.65	69,00	122
05.078.04	47,00	125	05.088.06X	699,00	6	05.088.68	28,70	150	05.090.66	7,00	103
05.078.07	69,00	117	05.088.105	290,00	14	05.088.69	16,34	29	05.090.67	112,00	104
05.081.04	16,00	35	05.088.109	220,00	15	05.088.70	20,90	29	05.090.68	67,00	104
05.081.05	16,00	35	05.088.109W	136,00	15	05.088.73	290,00	22	05.090.70	58,00	113
05.083.00	38,00	46	05.088.112	9,90	11	05.088.74	396,00	22	05.090.72	119,00	108
05.083.01	34,00	46	05.088.113	9,90	11	05.088.79	39,90	15	05.090.73	16,10	72
05.083.02	26,40	29	05.088.114	268,00*	88	05.088.82X	285,00	6	05.090.75	9,00	112
05.083.03	43,70	29	05.088.115	72,00	88	05.088.89X	611,00	6	05.090.76	34,00	112
05.083.04	26,00	46	05.088.116	370,00*	88	05.088.91	611,00	6	05.090.77	65,00	104
05.084.02L	155,00	31	05.088.117	80,00	88	05.088.94	56,00	98	05.090.78	69,00	104
05.084.04	86,70	45	05.088.119	699,00	6	05.088.99X	768,00	6	05.090.79	121,00	104
05.084.05P	194,00	30	05.088.120	768,00	6	05.089.00	58,70	124	05.090.80	123,00	104
05.084.07	128,00	32	05.088.121	542,00	6	05.090.00	55,00	124	05.090.81	158,00	104
05.084.11L	850,00	98	05.088.125	27,95	148	05.090.01	59,50	124	05.090.83	96,00	117
05.084.12	20,00	32	05.088.126	26,00	148	05.090.02	64,00	124	05.090.84	64,00	117
05.084.13	28,00	32	05.088.127	1.744,00	24	05.090.05	89,00	124	05.090.85	18,00	136
05.084.14	39,00	32	05.088.127.R1	560,00	25	05.090.07	48,00	114	05.090.88	8,00	103
05.084.15	92,00	32	05.088.128	112,00	28	05.090.08	48,00	116	05.090.95	449,00	7
05.084.16	48,00	32	05.088.129	17,50	151	05.090.10	98,00	65	05.090.96	292,95	7
05.084.17	185,00	32	05.088.130	176,00	97	05.090.13	49,00	65	05.090.97	45,70	148
05.084.21	59,00	153	05.088.131/100	1,80	24	05.090.14	27,00	126	05.090.98	22,00	151
05.084.22	299,00	46	05.088.131/150	2,00	24	05.090.15	57,00	126	05.090.99	480,00	10
05.084.25	94,00	30	05.088.131/200	2,00	24	05.090.16	86,00	123	05.091.02	92,00	136
05.084.26	224,00	31	05.088.131/25	1,60	24	05.090.17	29,90	123	05.091.04DP	148,00	101
05.084.28	585,00	16	05.088.131/50	1,60	24	05.090.22	11,00	135	05.091.04DPR1	30,00	101
05.084.35	504,00	16	05.088.131/75	1,80	24	05.090.23	16,50	125	05.091.05DP	171,00	100
05.085.00	53,00	32	05.088.132	3,50	24	05.090.24	15,00	103	05.091.05DPR1	30,00	100
05.085.01	35,30	32	05.088.133	6,90	24	05.090.25	31,50	136	05.091.11	135,00	101
05.085.04C	430,00	120	05.088.134	37,50	148	05.090.26	43,00	126	05.091.12	399,00	100
05.085.04L	550,00	120	05.088.135	258,00	23	05.090.29B	69,00	9	05.091.12.R1	42,00	100
05.085.05	148,00	121	05.088.136	498,00	23	05.090.30	39,00	8	05.091.13	110,00	102
05.085.07	62,00	122	05.088.137	598,00	28	05.090.31	40,00	8	05.091.14	82,00	102
05.085.08COMBI	248,00	45	05.088.137.R2	121,00	28	05.090.32	45,50	9	05.092.01	16,80	134
05.085.10	119,00	121	05.088.137.R3	209,00	28	05.090.33	39,85	8	05.096.03	10,90	149
05.085.11	94,00	30	05.088.137.R4	369,00	28	05.090.34	28,50	8	05.096.04	4,50	149
05.085.12	156,00	45	05.088.138	427,00	13	05.090.35	25,00	9	05.098.01	34,00	105
05.085.13	33,00	45	05.088.138.R1	244,00	24	05.090.36	19,80	8	05.098.02	49,00	115
05.085.14	62,80	121	05.088.140	598,00	4	05.090.37	12,80	8	05.100.00	11,00	37
05.085.16	1.980,00	17	05.088.141	306,00	6	05.090.38	12,90	8	05.100.01	11,00	37
05.085.17	1.360,00	119	05.088.142	1.369,00	26	05.090.39	29,50	9	WCR000103	42,60	73
05.085.18	1.680,00	119	05.088.143	508,95	6	05.090.40	20,00	9			
05.085.19	p.a.r.	20	05.088.144	577,95	6	05.090.41	17,40	9			
05.085.20	p.a.r.	18	05.088.145	665,00	6	05.090.42	13,70	8			

FINE SERIE  
SELL OUT

Cod. 05.088.140

€ 598,00



**7-DRAWER ROLL CAB** with 196 tools\* (5 full drawers)  
with stainless steel top and side door with key

**CARRELLO 7 CASSETTI** con 196 utensili\* (5 cassetti pieni)  
con piano inox e sportello laterale con chiave

60 mm (6)		SINGLE	INOX TOP	
		TOTAL		
140 mm (1)				69/73
		Ø 125 mm	775x460x800	785x485x760

SINGLE LOCKING FOR EACH DRAWER  
STAINLESS STEEL TOP  
PERFORATED TOOL HOLDER PANEL WITH KEY

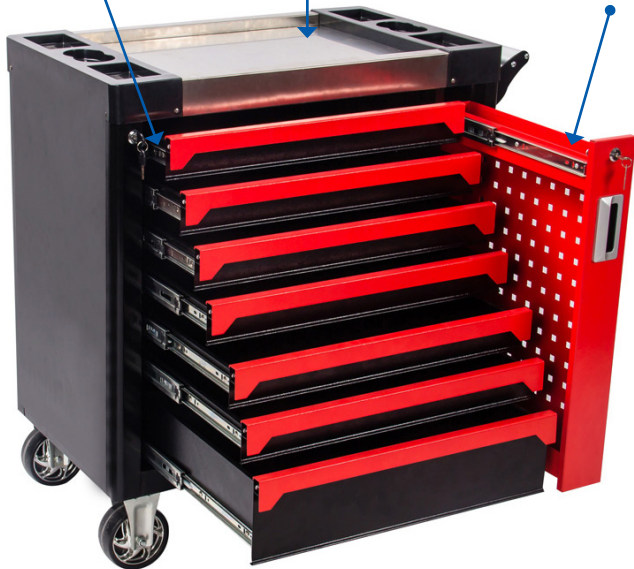

1



2

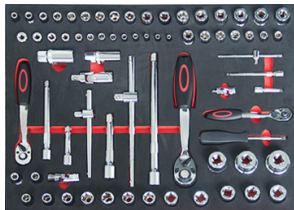

3



4



5



1



- 7PCS Screwdriver set, (-): SL6\*38 SL8\*175 SL3\*75
- SL6.0\*150 SL3.5\*75 SL5\*100 SL4\*100
- 7PCS Screwdriver set, (+): PH0\*75 PH1\*100 PH2\*100 PH2\*125
- PH3\*150 PH2\*38 PH4\*200
- 6PCS screwdriver
- PH1\*100, PH2\*100, SL3\*75, SL4\*100, SL5.5\*125, SL6.5\*150
- 7pcs precision screwdriver PH0, PH00, PH1, SL3.0, SL2.5, SL2.0, SL1.5
- 8pcs hex key



2

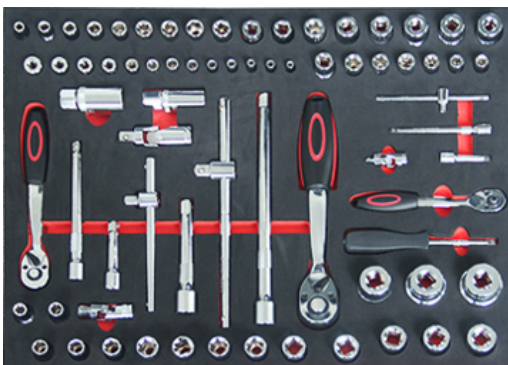

- 17pcs 1/2" DR 10-11-12-13-14-15-16-17-18-19-21-22-23-24-27-30-32 mm
- 1pc 1/2 universal joint
- 1pc 1/2 sliding bar
- 2pc 1/2 extension bar
- 1pc 1/2 ratchet handle 72T
- 17pcs-3/8" dr. Socket: 6-7-8-9-10-11-12-13-14-15-16-17-18-19-20-21-22 mm
- 1pcs 3/8" dr. universal joint
- 1pcs 3/8" dr. Sliding t bar
- 1pcs 3/8" dr x 3" extension bar
- 1pcs 3/8" dr x 6" extension bar
- 2pcs- 3/8" dr. Spark plug socket 16 21mm
- 7pcs-3/8" dr. Tx sockets: E8, E10, E12, E14, E16, E18, E20,
- 1pcs-3/8" ratchet handle
- 13pcs 1/4 dr socket 4-4.5-5-5.5-6-7-8-9-10-11-12-13-14 mm
- 1pc 1/4 universal joint
- 1pc 1/4 sliding bar
- 2pc 1/4 extension bar
- 1pc 1/4 ratchet handle 72T
- 1pc 1/4 sockets holder

3

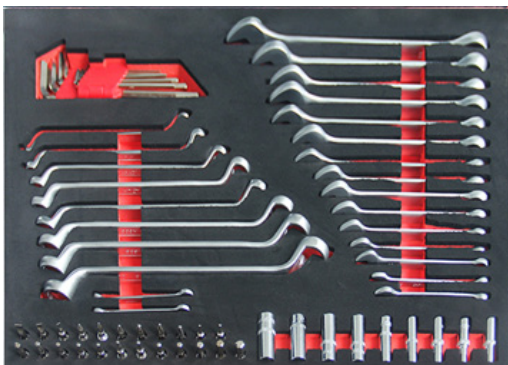

- 9pcs 1/4 deep sockets, 5-6-7-8-9-10-11-12-13 mm
- 23pcs 1/4 socket bits
- T8-10-15-20-25-27-30-40, PH1-2-3, PZ1-2-3, SL4-5.5-7, H3-4-5-6-7-8 mm
- 9pcs ball point hex key set, 1.5 mm, 2 mm, 2.5mm, 3mm, 4mm, 5mm, 6mm, 8mm, 10mm
- 8pcs Double Ring Wrench Set,
- 6x7, 8x9, 10x11, 12x13, 14x15, 16x17, 18x19, 20x22 mm
- 17pcs Combination Wrench set
- 6-7-8-9-10-11-12-13-14-15-16-17-18-19-20-21-22 mm

4



- 1pc 10" locking plier
- 1pc 10" D4 groove joint plier
- 8" long nose plier
- 7" diagonal plier
- 8" combination plier
- 6pcs Hex Key Wrench Set
- 2.0\*100mm, 2.5\*100mm, 3.0\*100mm
- 4.0\*150mm, 5.0\*150mm, 6.0\*150mm

5



- 1pc 5m measuring tape
- 1pc 1m folding ruler
- 1pc 9" level
- 1pc mini hack saw
- 1pc angle square
- 1pc 300g machinist's hammer
- 1pc 35mm rubber mallet
- Steel Files 1pc flat, 1pc half round, 1pc triangle, 1pc round, 1pc square (T8/T12)

PROMO 2022/2

CARRELLO 7 CASSETTI • 7-DRAWERS ROLL CAB • CARRITO DE 7 CAJÓNES

Prezzi netti per quantità / Net prices for min. q.ty



disponibile in 2 colori / available in 2 colors:  
nero / black ■ + rosso / red ■

VUOTO / EMPTY / VACIO	■	Cod. 05.088.55X	€ 319,00
	■	Cod. 05.088.55T	
+ BASIC kit 3	■	Cod. 05.088.56X	€ 542,95
	■	Cod. 05.088.121	
+ BASIC kit 4	■	Cod. 05.088.89X	€ 611,95
	■	Cod. 05.088.91	
+ PROFI kit 5	■	Cod. 05.088.06X	€ 699,00
	■	Cod. 05.088.119	
+ PROFI kit 6	■	Cod. 05.088.99X	€ 768,00
	■	Cod. 05.088.120	

	SINGLE	ABS TOP	 76,2
	TOTAL	ANTI-SHOCK PROTECTION	
		 770x465x980	 790x470x850

CARRELLO 6 CASSETTI • 6-DRAWERS ROLL CAB • CARRITO DE 6 CAJÓNES

Prezzi netti per quantità / Net prices for min. q.ty



VUOTO / EMPTY / VACIO	■	Cod. 05.088.82X	€ 285,00
+ BASIC kit 3	■	Cod. 05.088.143	€ 508,95
+ BASIC kit 4	■	Cod. 05.088.144	€ 577,95
+ PROFI kit 5	■	Cod. 05.088.145	€ 665,00
+ PROFI kit 6	■	Cod. 05.088.146	€ 734,00

	SINGLE	ABS TOP	 58,5
	TOTAL	ANTI-SHOCK PROTECTION	
		 780x460x900	 780x460x820

Cod. 05.088.48 € 223,95

BASIC kit 3

154 pz / pcs

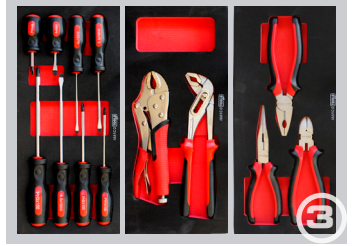
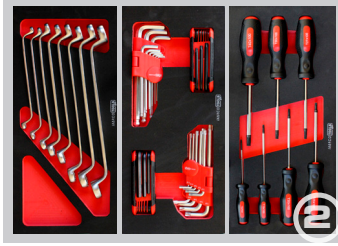
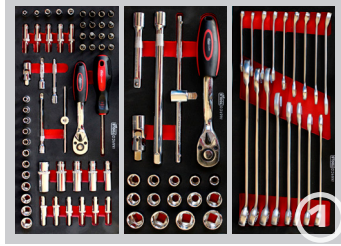

Cod. 05.090.96 € 292,95

BASIC kit 4

161 pz / pcs

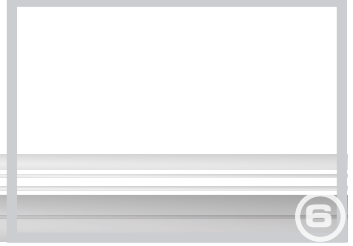
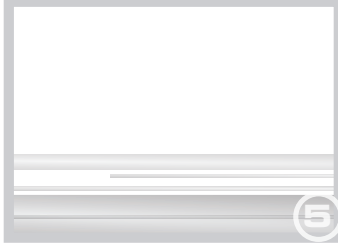
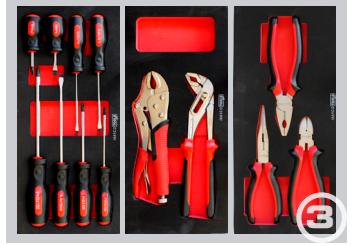
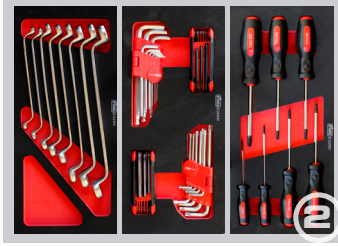
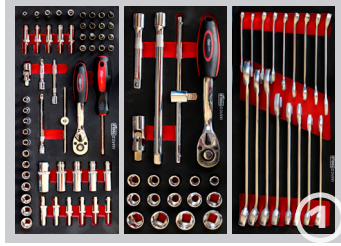

Cod. 05.088.47 € 380,00

PROFI kit 5

193 pz / pcs

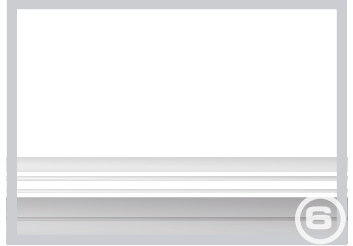
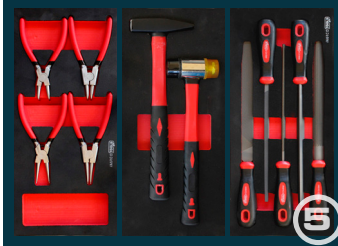
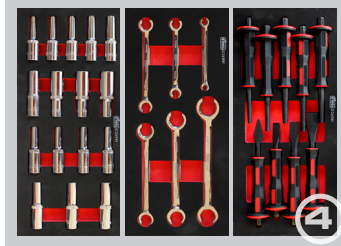
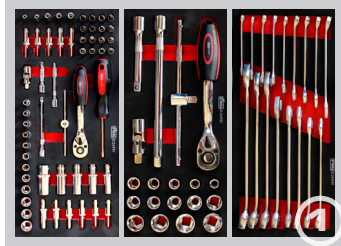

Cod. 05.090.95 € 449,00

PROFI kit 6

200 pz / pcs

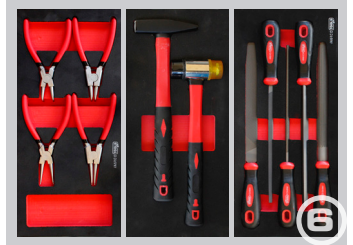
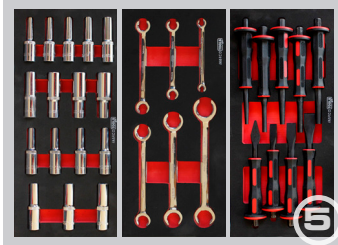
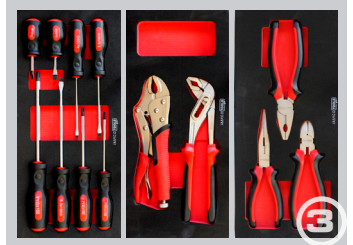
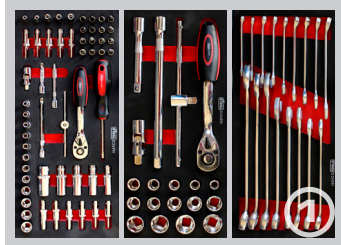

PROMO 2022/2

**KIT UTENSILI DA ESPOSIZIONE IN MORBIDA SPUGNA BICOLORE**  
**TOOLS EXHIBITION KITS IN SOFT TWO-COLOURED SPONGE**  
**KIT DE EXPOSICIÓN DE HERRAMIENTAS EN ESPONJA BLANDA DE DOS COLORES**



**Cod. 05.090.30 € 39,00**



**Set 54 bussole/accessori**  
**Kit of 54pcs socket wrenches 1/4"**  
**Juego de 54pcs llaves de tubo/accesorios 1/4"**  
 Materiale • Material: CR-V  
**Il set contiene • The kit includes • El kit incluye:**  
 Bussole • socket wrenches • Llaves de tubo  
 1/4" 4-4,5-5-6-7-8-9-10-11-12-13 mm  
 Bussole lunghe • Long socket wrenches • Llaves largas  
 1/4" 4-5-6-7-8-9-10-11-12-13-14 mm  
 Bussole • socket wrenches • Llaves torx  
 1/4" torx E 4-5-6-7-8  
 Barre estensione • Extension bars • Barras de extension  
 1/4" 50-75-100 mm  
 Inserti • Inserts • Insertos  
 1/4" PH1,2 - PZ1,2, SL 4,5 - 5, H3, 4, 5, 6, T8, T10, T15, T20, T25, T30

**Cod. 05.090.36 € 19,80**



**Set 34 chiavi esagonali a L**  
**Kit 34pcs hexagonal L-wrenches**  
**Juego de 34pcs llaves hexagonales en L**  
 Materiale • Material: CR-V  
**Il set contiene • The kit includes • El kit incluye:**  
 9 chiavi esag. • 9 hexagon keys • 9 llaves hex.  
 1,5 - 2 - 2,5 - 3 - 4 - 5 - 6 - 8 - 10mm  
 9 chiavi esag. SAE • 9 SAE hexagon keys • 9 llaves hex. SAE  
 1/16, 5/64, 3/32, 1/8, 5/32, 3/16, 1/4, 5/16, 3/8  
 8 chiavi torx • 8 torx keys • 8 llaves torx  
 T9, T10, T15, T20, T25, T27, T30, T40  
 8 chiavi esag. SAE • 8 SAE hexagon keys • 8 llaves hex. SAE  
 1/16, 5/64, 3/32, 1/8, 5/32, 3/16, 7/32, 1/4"

**Cod. 05.090.31 € 40,00**



**Set 19 bussole/accessori 1/2"**  
**Kit 19pcs socket wrenches/accessories 1/2"**  
**Juego de 19pcs llaves de tubo/accesorios 1/2"**  
 Materiale • Material: CR-V  
**Il set contiene • The kit includes • El kit incluye:**  
 Bussole Socket wrenches Llaves de tubo  
 1/2" 10 - 11 - 12 -13- 14 - 15 -16 -17- 18 - 19 - 21 - 22- 23 - 24mm  
 Barre estensione • Extension bars • Barras de extension  
 1/2" 125-150mm  
 Giunto girevole 1/2" • 1/2" Swivel joint • Junta rotatoria 1/2"  
 Barra scorrevole 1/2" • 1/2" Sliding bar • Barra corredera 1/2"  
 25mm  
 Cricchetto 1/2" • 1/2" Ratchet • Carraca 1/2"

**Cod. 05.090.37 € 12,80**



**Set 7 cacciaviti torx**  
**Kit 7pcs torx screwdrivers**  
**Juego de 7pcs destornilladores torx**  
 Materiale • Material: CR-V  
**Il set contiene • The kit includes • El kit incluye:**  
 T10/75, T15/100, T20/100, T25/100, T30/100, T40/100

**Cod. 05.090.33 € 39,85**



**Set 17 chiavi combinate**  
**Kit 17pcs combined wrenches**  
**Juego de 17pcs llaves combinadas**  
 Materiale • Material: CR-V  
**Il set contiene • The kit includes • El kit incluye:**  
 6-7-8-9-10-11-12-13-14-15-16-17-18-19-20-21-22mm

**Cod. 05.090.38 € 12,90**



**Set 8 cacciaviti a taglio e croce**  
**Kit 8pcs screwdrivers with flat and cross tip**  
**Juego de 8pcs destornilladores con punta plana y en cruz**  
 Materiale • Material: CR-V  
**Il set contiene • The kit includes • El kit incluye:**  
 6,5x1,2x38 4x08x100  
 5,5x1x100 6,5x1,2x150  
 2x38, 1x100 2x100, 3x150

**Cod. 05.090.34 € 28,50**



**Set 8 chiavi poligonali**  
**Kit 8pcs polygonal wrenches Material CR-V**  
**Juego de 8pcs llaves poligonales**  
 Materiale • Material: CR-V  
**Il set contiene • The kit includes • El kit incluye:**  
 6x7, 8x9, 10x11, 12x13, 14x15, 16x17, 18x19, 20x22mm

**Cod. 05.090.42 € 13,70**



**2 pinze L = 250mm**  
**2 pliers L = 250mm**  
**2 alicates L = 250mm**  
 Materiale • Material: CR-V  
**Il set contiene • The kit includes • El kit incluye:**  
 Pinza a coccodrillo • Crocodile clips • Pinza de crocodilo  
 L = 250mm  
 Pinza per lamiera • Plate grip Pinzas • de chapa  
 L = 250mm

PROMO 2022/2



	<p><b>Cod. 05.090.41 € 17,40</b></p>
	<p><b>Set 3 pinze</b> <b>Kit 3pcs pliers</b> <b>Juego de 3pcs alicates</b></p> <p>Materiale • Material: CR-V</p> <p><b>Il set contiene • The kit includes • El kit incluye:</b></p> <p>Pinza combinata • Combined pliers • Alicates combinados 200mm Pinza a becchi dritti • Straight nose pliers • Alicates de punta fina 200mm Tronchesi • Clippers • Tijeras</p>

	<p><b>Cod. 05.090.29B € 69,00</b></p>
	<p><b>Kit 7 chiavi a T snodate</b> <b>7 T-bended wrenches kit</b> <b>Juego de llaves de cubo a T</b></p> <p>Materiale • Material: CR-V</p> <p><b>Il set contiene • The kit includes • El kit incluye:</b></p> <p>7, 8, 10, 11, 13, 15, 17 mm</p>

	<p><b>Cod. 05.090.32 € 45,50</b></p>
	<p><b>Kit 16pcs bussole lunghe 1/2"</b> Materiale CR-V <b>Kit 16pcs long socket wrenches 1/2"</b> Material CR-V <b>Juego de 16pcs llaves de tubo largas 1/2"</b></p> <p>Materiale • Material: CR-V</p> <p><b>Il set contiene • The kit includes • El kit incluye:</b></p> <p>Chiavi esagonali • Hexagonal wrenches • Llaves hexagonales 1/2" 8-9-10-11-12-13mm Chiavi torx • Torx wrenches • Llaves torx 1/2" E10, E11, E12, E14, E16, E18, E20, E22, E24</p>

	<p><b>Cod. 05.090.43 € 19,55</b></p>
	<p><b>Kit 4pcs pinze seeger</b> <b>Kit 4pcs pliers for seeger</b> <b>Juego de 4pcs alicates para seeger</b></p> <p>Materiale • Material: CR-V</p> <p><b>Il set contiene • The kit includes • El kit incluye:</b></p> <p>Dritta per seeger interni • straight for internal seegers • recta para seeger internos Angolare per seeger interni • bent for internal seegers • curvada para seeger internos Dritta per seeger esterni • straight for external seegers • recta para seeger externos Angolare per seeger esterni • bent for external seegers • curvada para seeger externos</p>

	<p><b>Cod. 05.090.35 € 25,00</b></p>
	<p><b>Set 6pcs chiavi per tubi freni</b> <b>Kit 6pcs wrenches for brake hoses</b> <b>Juego de 6pcs de llaves para mangueras de frenos</b></p> <p>Materiale • Material: CR-V</p> <p><b>Il set contiene • The kit includes • El kit incluye:</b></p> <p>6*8 - 10*12 - 13*14 - 15*17 - 19*21 - 22*24mm</p>

	<p><b>Cod. 05.090.44 € 16,50</b></p>
	<p><b>2pcs martelli</b> <b>2pcs hammers</b> <b>2pcs martillos</b></p> <p><b>Il set contiene • The kit includes • El kit incluye:</b></p> <p>1pz martello • 1pc hammer • 1pc martillo 300gr 1pz mazzuolo in plastica • 1pc plastic mallet • 1pc mazo de plastico</p>

	<p><b>Cod. 05.090.39 € 29,50</b></p>
	<p><b>Kit 9pcs scalpelli</b> <b>Kit 9pcs chisels</b> <b>Juego de 9pcs cinceles</b></p> <p><b>Il set contiene • The kit includes • El kit incluye:</b></p> <p>3pz punta piatta • 3pcs flat head • 3pcs punta plana 19x12x180; 12x10x160; 16x12x175 2pz punta fine • 2pcs pin head • 2pcs punta fina 8x12x180; 10x12x180 2pz punta conica • 2pcs taper punch • 2pcs punta conica 6x10x180; 8x12x180 1pz punta triangolare • 1pc triangular head • 1pc punta triangular 6x10x180</p>

	<p><b>Cod. 05.090.40 € 20,00</b></p>
	<p><b>Kit 5pcs lime 8"</b> <b>Kit 5pcs files 8"</b> <b>Juego de 5pcs limas 8"</b></p> <p><b>Il set contiene • The kit includes • El kit incluye:</b></p> <p>1 lima piana • 1 flat file • 1 lima fina 1 lima mezza tonda • 1 half rounded file • 1 lima media redondeada 1 lima triangolare • 1 triangular file • 1 lima triangular 1 lima quadra • 1 square file • 1 lima cuadrada 1 lima tonda • 1 rounded file • 1 lima redondeada</p>

PROMO 2022/2

**3 SET EVA PER STRUMENTI ISOLATI PER I LAVORI SU VETTURE IBRIDE (CONFORME IEC 60900)**  
**3 EVA SETS FOR INSULATED TOOLS FOR SERVICE ON HYBRID CARS (ACCORDING TO IEC 60900)**  
**3 JUEGOS DE HERRAMIENTAS AISLADAS PARA EL MANTENIMIENTO EN COCHES HÍBRIDOS (SEGÚN IEC 60900)**

**HYBRID  
CARS**

Cod. 05.090.99

€ **480,00**

**NEW!  
2022**

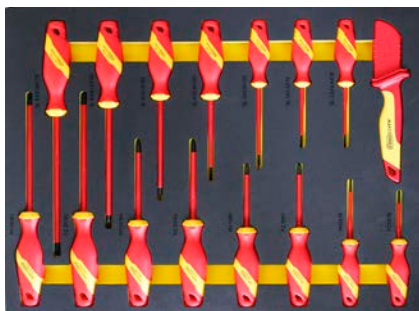

1	Insulated Combination Pliers, 200mm	
2	Insulated Wire Stripping Pliers, 160mm	
3	Insulated Flat Nose Pliers, 200mm	
4	Insulated High Leverage Long Snipe Nose Pliers, 200mm	
5	Insulated Cable Cutting Pliers, 160mm	
6	Insulated Slotted Screwdriver, 2.5*0.4*75mm	
7	Insulated Slotted Screwdriver 3*0.5*75mm	
8	Insulated Slotted Screwdriver 3*0.5*100mm	
9	Insulated Slotted Screwdriver 4*0.8*100mm	
10	Insulated Slotted Screwdriver 5.5*1*125mm	
11	Insulated Slotted Screwdriver 6.5*1.2*150mm	
12	Insulated Slotted Screwdriver 8.0*1.6*175mm	
13	Insulated Phillips Screwdriver PH0*75mm	
14	Insulated Phillips Screwdriver PH1*80mm	
15	Insulated Phillips Screwdriver PH2*100mm	
16	Insulated Phillips Screwdriver PH3*150mm	
17	Insulated Pozidriv Screwdriver PZ0*60mm	
18	Insulated Pozidriv Screwdriver PZ1*80mm	
19	Insulated Pozidriv Screwdriver PZ2*100mm	
20	Insulated Pozidriv Screwdriver PZ3*150mm	
21	VDE Insulated Cable Knife 190mm/208mm (52mm blade)	

22	1/2" Insulated Sockets 10mm	
23	1/2" Insulated Sockets 11mm	
24	1/2" Insulated Sockets 12mm	
25	1/2" Insulated Sockets 13mm	
26	1/2" Insulated Sockets 14mm	
27	1/2" Insulated Ratchet Wrench 250mm	
28	1/2" Insulated Extension Bar 125mm	
29	1/2" Insulated Extension Bar 250mm	
30	Insulated Ring Wrench 6mm	
31	Insulated Ring Wrench 7mm	
32	Insulated Ring Wrench 8mm	
33	Insulated Ring Wrench 9mm	
34	Insulated Ring Wrench 10mm	
35	Insulated Ring Wrench 11mm	
36	Insulated Ring Wrench 12mm	
37	Insulated Ring Wrench 13mm	
38	Insulated Ring Wrench 14mm	
39	Insulated Ring Wrench 15mm	
40	Insulated Ring Wrench 16mm	
41	Insulated Ring Wrench 17mm	
42	Insulated Ring Wrench 18mm	
43	Insulated Ring Wrench 19mm	

PROMO 2022/2

■ Cod. 05.088.141 € 306,00

VUOTO / EMPTY / VACIO



Cod. 05.090.99 € 480,00

3 EVA SET

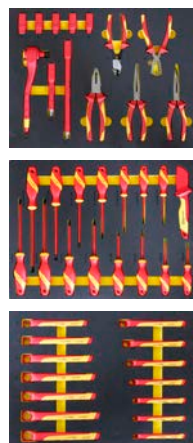

NEW!  
2022

+

=

€ 786,00

Cod. 05.088.30 € 110,00

CASSETTIERA PORTA UTENSILI PORTATILE (VUOTA)  
PORTABLE TOOL DRAWER BOX (EMPTY)  
CAJONERA PORTAHERRAMIENTAS MÓVIL (VACÍA)



	③ 150x225x30	TOTAL	KG
	② 570x225x30	KEY	11/12
	① 570x225x30	600x260x345	660x31x41

COPERTINE DI NYLON • NYLON COVERS • CUBIERTAS DE NYLON

Cod. 05.088.112 € 9,90



- Copertina in nylon per carrello 05.088.141
- Colore nero
- Dimensioni: 78,5x52,5x78cm

- Nylon cover for trolley 05.088.141
- Black color
- Size: 78,5x52,5x78cm

Cod. 05.088.113 € 9,90



- Copertina in nylon per carrelli 05.088.55, 05.088.50R-EVA, B-EVA, G-EVA + 05.088.150
- Colore nero
- Dimensioni: 84x52x82cm

- Nylon cover for 05.088.55, 05.088.50R-EVA, B-EVA, G-EVA + 05.088.150
- Black color
- Size: 84x52x82cm



BUDGET

Cod. 05.088.150

€ 499,00

NEW!

**CARRELLO 7 CASSETTI** con 172 utensili (4 cassette piene) su supporto di morbida spugna

**7-DRAWER ROLL CAB** with 172 tools (4 full drawers) on soft sponge support

**CARRITO DE 7 CAJÓNES** con 172 herramientas (4 cajones llenos) en soporte de esponja blanda

	<b>SINGLE</b> 	<b>ABS TOP</b>	 KG 76,2
	<b>TOTAL</b> 	<b>ANTI-SHOCK PROTECTION</b>	 770x460x908
		 780x480x1020	

1

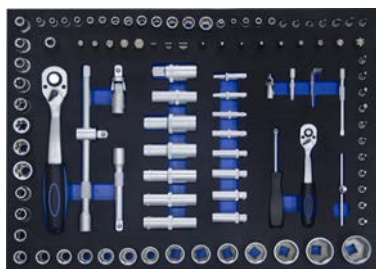

**108 PCS SOCKET SET TOOL TRAY**

- Phillips screwdriver - 2x38 mm
- Phillips screwdriver - PH 0x75 mm
- Phillips screwdriver - PH 1 x 100 mm
- Phillips screwdriver - PH 2 x 100 mm
- Phillips screwdriver - PH 3 x 150 mm
- Phillips screwdriver - PH 4 x 200 mm
- Slotted screwdriver - SL 6x38 mm
- Slotted screwdriver - SL 3x100 mm
- Slotted screwdriver - SL 5x75 mm
- Slotted screwdriver - SL 6x100 mm
- Slotted screwdriver - SL 8x150 mm
- Slotted screwdriver - SL 10x200 mm
- Set of 9 allen keys "L" shaped with round end
- Set of 9 torx keys L-shaped

2

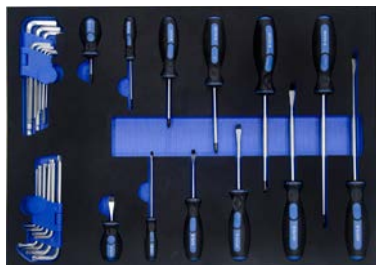

**30 PCS SCREWDRIVER AND "L" KEY SET TRAY**

- 1x 1/2" universal ratchet handle
- 1x 1/2" \*5/16" head adapter
- 5x 1/2" deep sockets(6PT): 14, 15, 17, 19, and 22 mm
- 17x 1/2" metric sockets(6PT): 10, 11, 12, 13, 14, 15, 16, 17, 18, 19, 20, 21, 22, 24, 27, 30, and 32 mm.
- 8x 1/2" star sockets: E10, E11, E12, E14, E16, E18, E20 and E24
- 2x 1/2" spark plug sockets: 16 mm and 21 mm
- 2x extension bars: 5" and 10" with sliding head.
- 1x 1/2" universal joint.
- 1x 1/4" universal ratchet handle.
- 18x bit sockets: PH: #1, #2 / PZ: #1 and #2 / HEX: 3, 4, 5, 6 mm / SL: 4, 5.5, 6.5 mm / TX: 8, 10, 15, 20, 25, 27, 30 mm
- 1x 1/4" spin handle
- 1x 1/4" universal joint
- 1x 1/4" slide handle
- 2x extension bars: 2", 5"
- 13x metric sockets(6PT): 4, 4.5, 5, 5.5, 6, 7, 8, 9, 10, 11, 12, 13, 14 mm
- 8x 1/4" deep sockets(6PT): 6, 7, 8, 9, 10, 11, 12, and 13 mm
- 5x 1/4" star sockets: E4, E5, E6, E7, and E8
- 17x bits (8 mm): HEX: 7, 8, 10, 12, 14 mm / SL: 8, 10, 12 mm / PH: #3, #4 / PZ: #3, #4 / TX: 40, 45, 50, 55, 60 mm
- 3x Allen keys: 1.5, 2, 2.5 mm

3



**25 PIECE SPANNER SET TRAY**

- Double end ring spanner - 6x7mm, 8x9mm, 10x11mm, 12x13mm, 14x15mm, 16x17mm, 18x19mm, 20x22mm
- Combination spanner: 6-7-8-9-10-11-12-13-14-15-16-17-18-19-20-21-22mm

4



**9 PCS HAMMER AND PLIER SET TRAY**

- Ball pein hammer
- Install hammer
- Water pump plier 10"
- 7" internal circlip pliers ( straight tips)
- 7" external circlip pliers (straight tips)
- Locking plier 10"
- Diagonal plier 7.5"
- Long nose plier 8"
- Measuring tape 3m

Cod. 05.088.138 € 427,00



**CARRELLO 6 CASSETTI** con 172 utensili/4 cassette pieni su supporto di morbida spugna\*

**6-DRAWER ROLL CAB** with 172 tools/4 full drawers on soft sponge support\*

**CARRITO DE 6 CAJONES** con 172 herramientas/4 cajones llenos en soporte de esponja blanda\*

\*stessa dotazione del modello 05.088.150

\*same sets as cod. 05.088.150

\*mismo equipamiento que el modelo 05.088.150

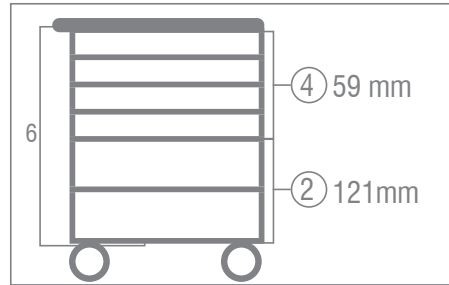
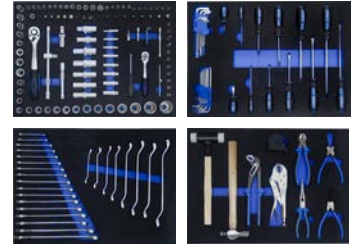

TOTAL 	RUBBER TOP	 KG 60
	 600x400x783	 660x460x720



Cod. 05.088.40 € 179,00



**CARRELLO 5 CASSETTI • 5-DRAWERS ROLL CAB • CARRO 5 CAJONES VUOTO • EMPTY • VACÍO**

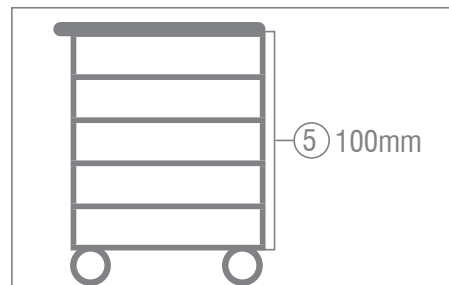

RUBBER TOP	
TOTAL 	 KG 27,2
 615x330x762	 680x385x730

GUIDA SU CUSCINETTI  
BALL BEARING SLIDES  
GUIA CON COJINETES DE BOLAS

Cod. 05.088.147 € 169,00

**4 VASSOI PORTAUTENSILI EVA PER 05.088.40 (107 UTENSILI)**

**4 EVA TOOL TRAYS FOR 05.088.40 (107 TOOLS)**

**4 PORTAHERRAMIENTAS EVA PARA 05.088.40 (107 HERRAMIENTAS)**

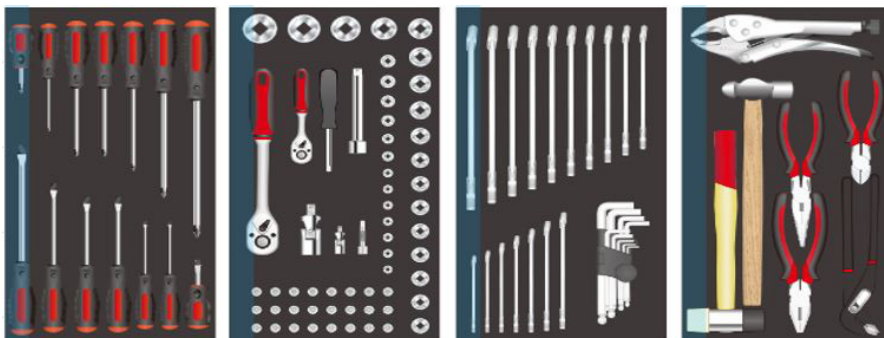

PROMO 2022/2

CARRELLO MULTIFUNZIONE • MULTIFUNCTIONAL TROLLEY • CARRO MULTIFUNCIONAL

Cod. 05.088.105

€ 290,00

GOLDEN MATE

Cod. 05.088.105/N CUSTOM (NO LOGO)

disponibile in 2 colori / available in 2 colors:  
nero / black ■ + argento / silver ■



DATI TECNICI:

- Dotato di 3 piani di appoggio
- 1 piano scorrevole per tastiera PC
- Porta rotolo
- 3 avvolgicavi in acciaio
- 3 contenitori per materiali di consumo laterali (in acciaio)
- Un vano porta tester con chiave
- 2 ruote fisse e 2 piroettanti (1 con freno)
- Dimensioni (carrello montato): 48x60x107 cm
- Fornito in kit di montaggio
- Dim. imballo 53x108x13 Peso, 42 kg
- Peso: 37 kg

TECHNICAL DATA:

- Equipped with 3 support surfaces
- 1 sliding top for PC keyboard
- Roll holder
- 3 steel cable reels
- 3 side containers for consumables (steel)
- Compartment for other devices with key
- 2 Fixed and 2 swivel castor wheels (1 with brake)
- Dimensioni (carrello montato): 48x60x107 cm
- Supplied in a mounting kit
- Packing size 53x108x13 cm, weight 42kgs
- Weight: 37kgs

UN VERO "COMPAGNO" PER LA TUA ATTIVITÀ DI AUTORIPARATORE  
A REAL "BUDDY" FOR YOUR ACTIVITY AS A CAR REPAIRER



LOGISTICA DI MAGAZZINO • WAREHOUSE LOGISTICS • LOGÍSTICA DE ALMACÉN



300 Kg

Cod. 05.088.109 € 220,00

CARRELLO 3 PIANI TIPO PESANTE / 3-LEVEL HEAVY DUTY TROLLEY

- carrello in acciaio verniciato (uso industriale)
- 2 ruote fisse, 2 piroettanti Ø125 mm con freno
- tappeti in gomma antiolio
- portata 300 kg
- Fornito con il kit di montaggio

- trolley in painted steel (industrial use)
- 2 Fixed wheels, 2 pivoting 125 mm diameter with brake
- Anti-oil rubber mats
- capacity 300 kgs
- In mounting kit



Cod. 05.088.02 € 62,00

100 Kg

765x400x845

730x400x180

20 KG



300 Kg

SPECIAL VERSION

Cod. 05.088.109W € 136,00

CARRELLO 3 PIANI TIPO PESANTE / 3-LEVEL HEAVY DUTY TROLLEY

- carrello in acciaio verniciato (uso industriale)
- 2 ruote fisse, 2 piroettanti Ø125 mm con freno
- tappeti in gomma antiolio
- portata 300 kg
- Fornito con il kit di montaggio

Prezzi netti per quantità / Net prices for min. q.ty

- trolley in painted steel (industrial use)
- 2 Fixed wheels, 2 pivoting 125 mm diameter with brake
- Anti-oil rubber mats
- capacity 300 kgs
- In mounting kit



Cod. 05.088.25 € 43,00



100 Kg

Cod. 05.088.03 € 33,00



70 Kg

Cod. 05.088.79 € 39,90



- Ruote in poliuretano piene
  - Solid polyurethane wheels
  - Ruedas de poliuretano sólido
- ø 260mm



200 Kg





Cod. 05.084.35

€ 504,00

**PIATTAFORMA MOBILE A FORBICE SINGOLA CON SOLLEVAMENTO A PEDALE**

**MOBILE SINGLE-SCISSOR LIFTING PLATFORM WITH PEDAL SYSTEM**

**PLATAFORMA ELEVADORA MÓVIL DE TIJERA SIMPLE CON SISTEMA DE PEDAL**

- Capacità: 500 kg
- Pompa a pedale
- Altezza min.: 390 mm
- Altezza max.: 900 mm
- Dimensioni piattaforma: 815x500x55mm
- Ruote girevoli: Ø 127
- Dimensioni imballo: 900x520x390mm
- Peso: 81 kg
- Capacity: 500 kg
- Pedal pump
- Min. Height: 390 mm
- Max. Height: 900 mm
- Platform dimensions: 815x500x55mm
- Caster wheels: Ø 127
- Packaging dimensions: 900x520x390mm
- Weight: 81 kg
- Capacidad: 500 kg
- Bomba de pedal
- Altura min.: 390 mm
- Altura max.: 900 mm
- Dimensiones plataforma: 815x500x55mm
- Ruedas giratorias: Ø 127
- Dimensiones embalaje: 900x520x390mm
- Peso: 81 kg



Cod. 05.084.28

€ 585,00

**PIATTAFORMA MOBILE A DOPPIA FORBICE CON SOLLEVAMENTO A PEDALE**

**DOUBLE-SCISSOR LIFTING PLATFORM WITH PEDAL SYSTEM**

**PLATAFORMA ELEVADORA DE DOBLE TIJERA CON SISTEMA DE PEDAL**

- Capacità: 350 kg
- Pompa a pedale
- Altezza min.: 395 mm
- Altezza max.: 1300mm
- Dimensioni piattaforma: 905x512x55mm
- Ruote girevoli: Ø 127
- Dimensioni imballo: 1000x520x420mm
- Peso: 100 kg
- Capacity: 350 kg
- Pedal pump
- Min. Height: 395 mm
- Max. Height: 1300mm
- Platform dimensions: 905x512x55mm
- Caster wheels: Ø 127
- Packaging dimensions: 1000x520x420mm
- Weight: 100 kg
- Capacidad: 350 kg
- Bomba de pedal
- Altura min.: 395 mm
- Altura max.: 1300mm
- Dimensiones plataforma: 905x512x55mm
- Ruedas giratorias: Ø 127
- Dimensiones embalaje: 1000x520x420mm
- Peso: 100 kg



Cod. 05.085.16

€ 1.980,00

NEW!

**PIATTAFORMA DI SOLLEVAMENTO IDRAULICA (A DOPPIA FORBICE)***per motori, cambi e pacchi batterie al litio di vetture ibride***HYDRAULIC LIFTING PLATFORM (DOUBLE SCISSOR LIFT)***for engines, gear boxes and lithium battery packs of hybrid cars***PLATAFORMA ELEVADORA HIDRÁULICA (ELEVADOR DE DOBLE TIJERA)***para motores, cajas de cambios y paquetes de baterías de litio de automóviles híbridos*1000  
Kg

- Max. altezza: 180 cm
- Min. altezza: 50 cm
- Range sollevamento: 50 ÷ 180 cm
- Dimensioni piattaforma: 130x80x7 cm
- Sfere di scorrimento
- Capacità: 1000 kg
- Ruote in poliuretano con freno e blocco
- Pompa idraulica a pedale
- Dimensioni imballo: 160x90x131 cm
- Peso: 300 kg

- Max. Height: 180 cm
- Min. height: 50 cm
- Lifting range: 50 ÷ 180 cm
- Platform dimensions: 130x80x7 cm
- Scrolling spheres
- Capacity: 1000 kg
- Polyurethane wheels with brake and lock
- Hydraulic foot pump
- Packaging dimensions: 160x90x131cm
- Weight: 300 kg

- Altura máx: 180 cm
- Altura mínima: 50 cm
- Range de elevación: 50 ÷ 180 cm
- Dimensiones de la plataforma: 130x80x7 cm
- Esferas de desplazamiento
- Capacidad: 1000 kg
- Ruedas de poliuretano con freno y cerradura
- Bomba de pie hidráulica
- Dimensiones de embalaje: 160x90x131cm
- Peso: 300 kg



POMPA A PEDALE  
FOOT CONTROL PUMP  
BOMBA DE PIE

Cod. 05.085.20

Prezzo a richiesta  
Price on request**PONTE A FORBICE ELETTRIDRAULICO DA 2,7 TON**  
per carrozzerie**2,7 TONS LOW-RISE ELECTRO-HYDRAULIC SCISSOR LIFT**  
for body shops**ELEVADOR DE TIJERA ELECTROHIDRÁULICO DE 2,7 TONELADAS**  
para talleres de carrocería

- Questo ponte elettroidraulico a forbice è idoneo per vetture e veicoli commerciali leggeri con peso totale non superiore a **2700 kg**
- Il sollevatore è dotato di un **blocco meccanico di sicurezza**
- Il suo principale vantaggio è che durante tutto il tempo di attesa del sollevatore si trova in posizione di sicurezza e si sblocca solo al momento della discesa da parte dell'operatore. Questa soluzione evita errori di disattivazione del sistema di sicurezza e **riduce a zero la possibilità di lasciare il veicolo incontrollato**
- Il sollevatore è dotato di **bracci regolabili** con ampia gamma di lavoro
- This electro-hydraulic scissor lift is suitable for cars and light commercial vehicles with a total weight not exceeding **2700 kg**
- The lift is equipped with a **mechanic safety lock** designed for the operator's safety
- Its main advantage is that during the entire lifetime of the lift, it is in the secured position and is released only for the time of lowering by the operator. This solution prevents deactivation by mistake of the security system and **reduces the possibility of uncontrolled leaving of the vehicle to zero**
- This lift is equipped with adjustable **load-bearing arms** with a wide range of work
- Este elevador de tijera electrohidráulico es adecuado para automóviles y vehículos comerciales ligeros con un peso total que no exceda los **2700 kg**.
- Este elevador está equipado con un **bloqueo de seguridad mecánico** diseñado para la seguridad del operador.
- Su principal ventaja es que durante toda la vida útil del ascensor, éste se encuentra en la posición asegurada y solo se suelta durante el tiempo de descenso por parte del operador. Esta solución evita la desactivación por error del sistema de seguridad y **reduce a cero la posibilidad de salida incontrolada del vehículo**.
- Este elevador está equipado con **brazos de carga ajustables** con una amplia gama de trabajo



**CARATTERISTICHE TECNICHE:**

- Sollevatore elettroidraulico mobile
- Portata: 2700 kg
- Potenza motore: 2,2 kw, 230V 1ph
- Altezza di sollevamento: 180 ÷ 1400 mm
- Tempo di risalita/discesa: 50/30 sec
- Centralina elettro-idraulica con serbatoio olio di 10 lt
- Tipo di olio idraulico: 46
- Dimensioni piano appoggio con bracci: 1000-1476 mm
- Spessore solaio in cemento armato: 300 mm (A RICHIESTA)
- Tipo di cemento: B25
- Peso netto/lordo: 478/500 kg
- Dimensioni imballo: 260x108x71cm

**CARATTERISTICHE TECNICHE:**

- Movable electro-hydraulic lift
- Capacity: 2700 kg
- Motor power: 2.2 kw, 230V 1ph
- Lifting height: 180 ÷ 1400 mm
- Ascent / descent time: 50/30 sec
- Electro-hydraulic unit with 10 lt oil tank
- Type of hydraulic oil: 46
- Support surface with arms dimensions: 1000-1476 mm
- Thickness of reinforced concrete floor: 300 mm (OPTIONAL)
- Type of cement: B25
- Net / gross weight: 478/500 kg
- Packaging dimensions: 260x108x71cm

**CARACTERÍSTICAS TÉCNICAS:**

- Elevador electrohidráulico móvil
- Capacidad: 2700 kg
- Potencia motor: 2,2 kw, 230V 1ph
- Altura de elevación: 180 ÷ 1400 mm
- Tiempo de subida/bajada: 50/30 seg
- Grupo electrohidráulico con depósito de aceite de 10 lt.
- Tipo de aceite hidráulico: 46
- Dimensiones de aplicación de tapa con brazos: 1000-1476 mm
- Espesor del piso de hormigón armado: 300 mm (bajo pedido)
- Tipo de cemento: B25
- Dimensiones del embalaje: 160x180x65cm

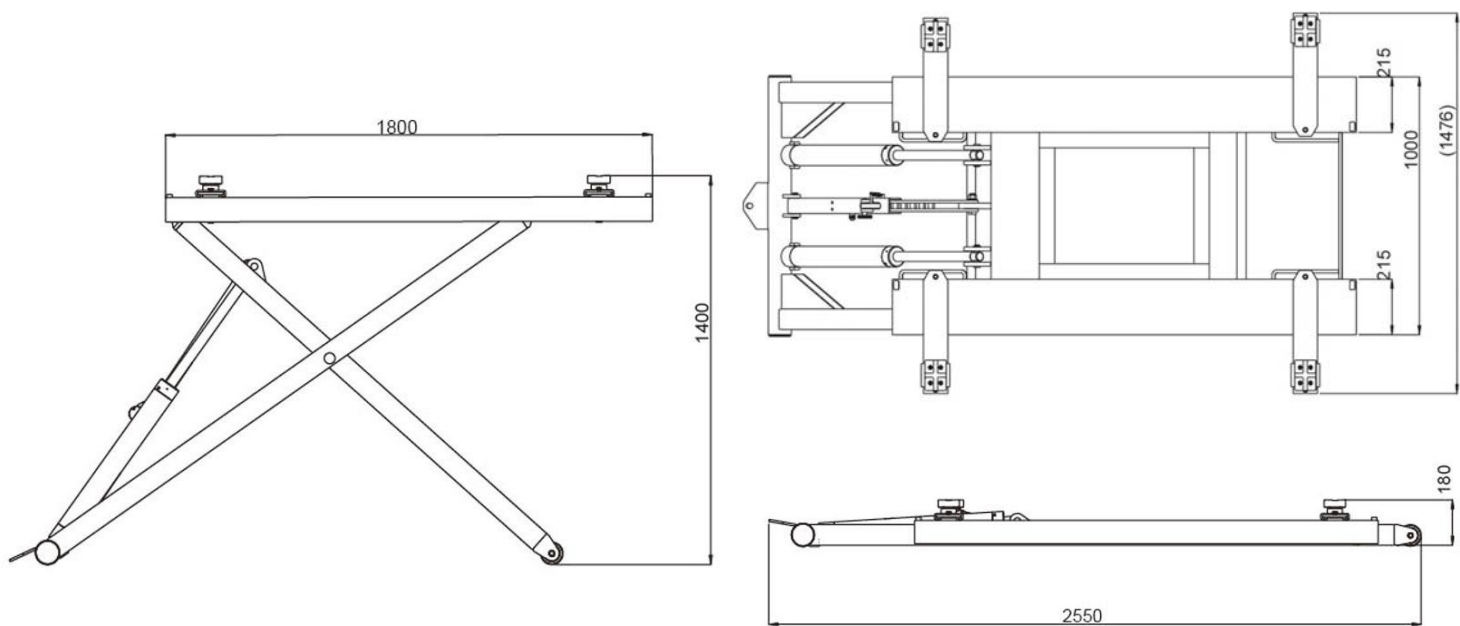

PROMO 2022/2

Cod. 05.085.19

Prezzo a richiesta  
Price on request**SOLLEVATORE A FORBICE ELETTROIDRAULICO A BASSA ALZATA DA 3 TON**

completo di carrello e ruote per spostamento (per gommisti)

**3 TON LOW-RISE ELECTRO-HYDRAULIC SCISSOR LIFT**

complete with handling kit (for tire specialists)

**ELEVADOR DE TIJERA ELECTROHIDRÁULICO DE 3 TONELADAS**

completo con kit de manejo (para los especialistas en neumáticos)

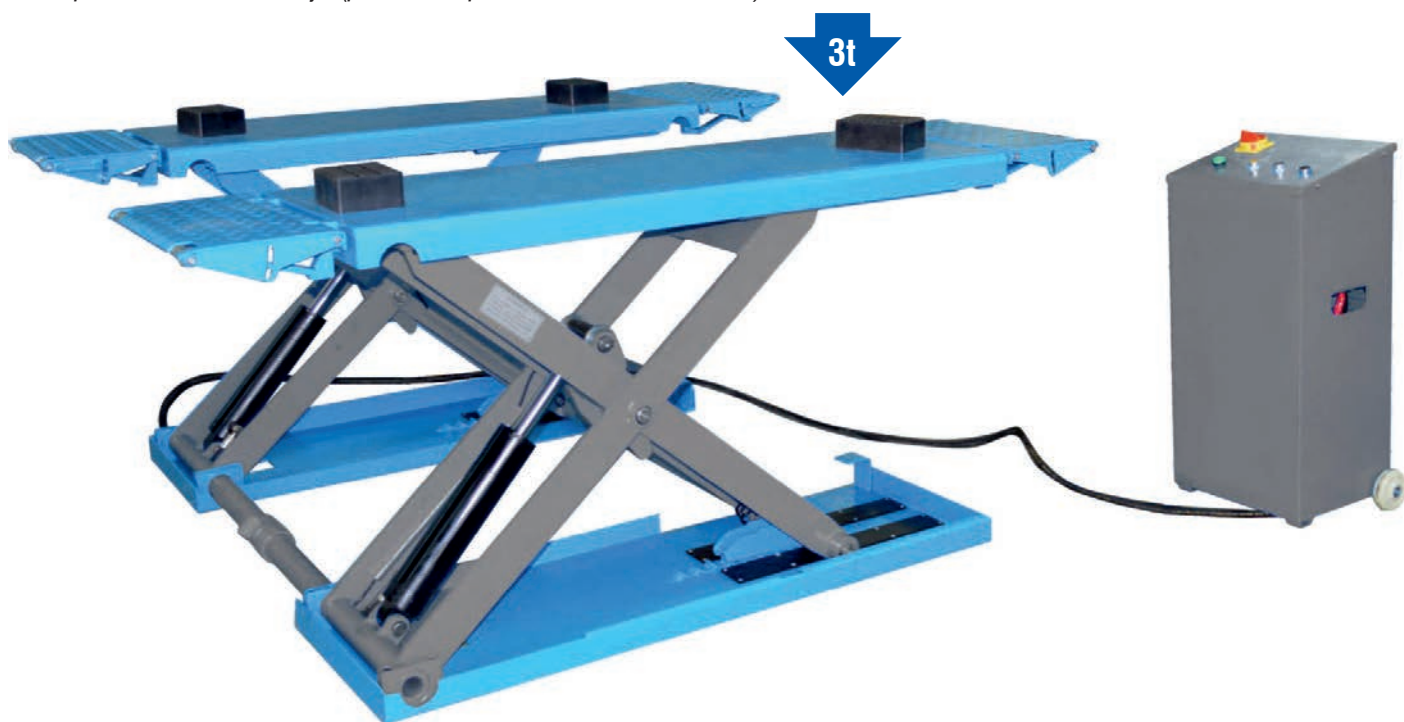
**CARATTERISTICHE TECNICHE:**

- Sollevatore elettroidraulico mobile
- Portata: 3000 kg
- Altezza di sollevamento: 110÷1000 mm
- Lunghezza piattaforma: 1400-1900 mm
- Sgancio arpioni pneumatico
- Sincronizzazione meccanica dei movimenti delle pedane
- Tamponi in gomma e set per il movimento del sollevatore inclusi
- Dispositivi di sicurezza in accordo con EN1493:2010
- Serbatoio olio di 10 lt
- Alimentazione: 400 V/50 Hz
- Alimentazione pneumatica: 6-8 bar
- Potenza motore: 2,2 kw
- Livello di rumore: <70 dB
- Peso: 550 kg
- Dimensioni imballo: 160x180x65cm

**CARATTERISTICHE TECNICHE:**

- Easy movable electro-hydraulic lift
- Capacity: 3000 kg
- Lifting height: 110÷1000 mm
- Platform length: 1400-1900 mm
- Mechanical height lock pneumatically released
- Mechanically synchronized adjustable platforms
- Rubber pads and moving set included
- Safety appliances according to EN1493: 2010
- 10 lt oil tank
- Power supply: 400 V / 50 Hz
- Pneumatic supply: 6-8 bar
- Motor power: 2.2 kw
- Noise level: <70dB
- Weight: 550 kg
- Packaging dimensions: 160x180x65cm

**CARACTERÍSTICAS TÉCNICAS:**

- Elevador electrohidráulico de fácil desplazamiento
- Capacidad: 3000 kg
- Altura de elevación: 110÷1000 mm
- Longitud de la plataforma: 1400-1900 mm
- Bloqueo mecánico de altura liberado neumáticamente
- Plataformas ajustables sincronizadas mecánicamente
- Almohadillas de goma y set móvil incluidos.
- Aparatos de seguridad según EN1493:2010
- Depósito de aceite de 10 lt.
- Fuente de alimentación: 400 V / 50 Hz
- Alimentación neumática: 6-8 bar
- Potencia del motor: 2,2 kw
- Nivel de ruido: <70dB
- Peso: 550 kg
- Dimensiones del embalaje: 160x180x65cm



3t

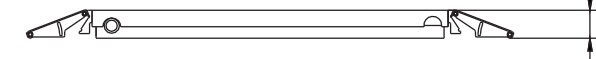
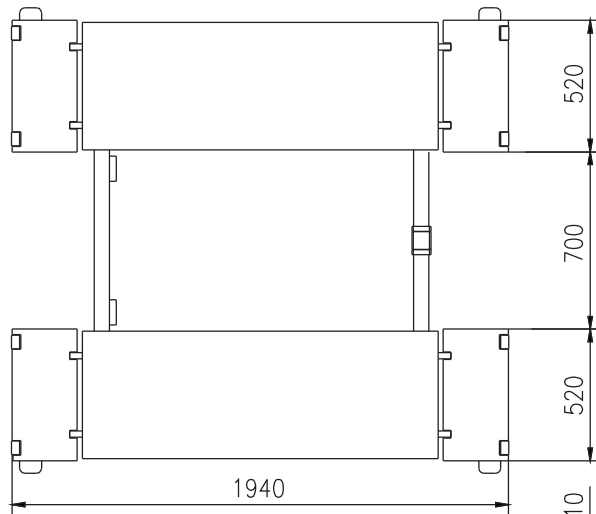
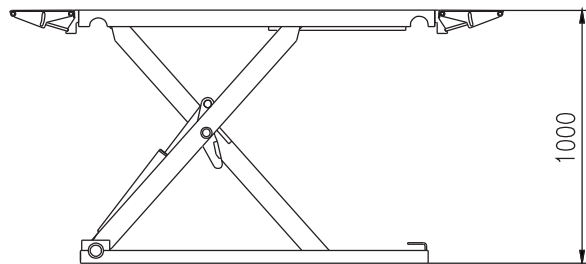

PROMO 2022/2

**TAVOLI DA LAVORO CON PANNELLO PORTA CHIAVI**  
**FOLDABLE WORK BENCH WITH TOOLS HOLDER PANEL**

Cod. 05.088.149

€ 189,00

**TAVOLO DA LAVORO CON PANNELLO PORTA CHIAVI**  
**FOLDABLE WORK BENCH WITH TOOLS HOLDER PANEL**  
**BANCO DE TRABAJO PLEGABLE CON PANEL PORTAHERRAMIENTAS**

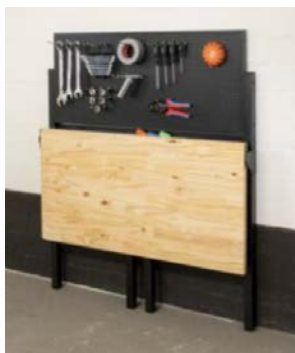

- Plano in legno multistrato
- Dimensioni (montato): 120x64xh144 cm
- Imballo 132x173x10 cm
- Peso 30,6 kg
- multi-layer wood top
- Dimensions (assembled): 120x64xh144 cm
- Packaging 132x173x10 cm
- Weight 30.6 kg
- Plano en madera multicapa
- Dimensiones (montado): 120x64xh144 cm
- Embalaje 132x173x10 cm
- Peso 30,6 kg

Cod. 05.088.73

€ 290,00

800 kg



DISPONIBILE MODELLO DA 1MT, COD. 05.088.72

- 1.6 mt, 1 cassetto, 1 ripiano inferiore
- Lamiera piano appoggio da 30/10, altezza bordi 40mm
- Cassetto con guida su cuscinetti e chiave
- In kit di montaggio
- 1.6 mt, 1 drawer ,1 lower rack.
- Sheet metal worktop thickness 30/10, height of edges: 40mm
- Drawer with guide bearings and key
- In mounting kit
- 1.6mt,1 cajón, 1 estante inferior
- Espesor de la plancha de metal de trabajo de 30/10, altura de los bordes 40mm
- Cajon con cojinetes de guía y clave
- Kit de montaje

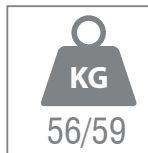

Cod. 05.088.74

€ 396,00

1000 kg



- 2 mt, 2 cassetti, 1 ripiano inferiore, 6 gambe
- Lamiera piano appoggio da 30/10, altezza bordi 40mm
- 2 cassetti con guida su cuscinetti e chiave
- In kit di montaggio
- 2 mt, 2 drawers ,1 lower rack.
- Sheet metal worktop thickness 30/10, height of edges: 40mm
- 2 drawers with guide bearings and key
- In mounting kit
- 2mt,2 cajones, 1 estante inferior
- Espesor de la plancha de metal de trabajo de 30/10, altura de los bordes 40mm
- 2 cajones con cojinetes de guía y clave
- Kit de montaje



Cod. 05.088.135

€ 258,00

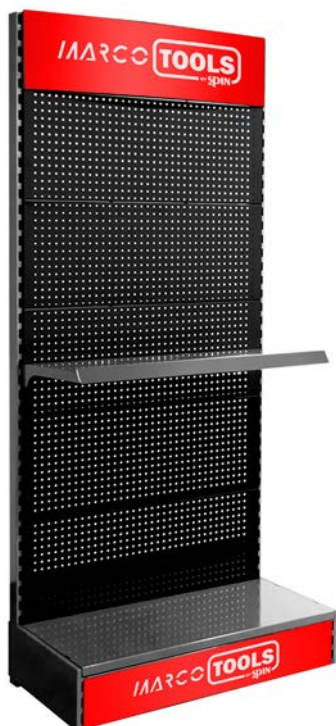

**ESPOSITORE CON PANNELLI FORATI PORTAUTENSILI  
PERFORATED TOOL-HOLDER PANEL  
PANEL PORTAHERRAMIENTAS PERFORADO**

- 5 pannelli perforati, 96x35 cm, fori tondi
- 3 ripiani: 96,8x35 cm
- 20 ganci in acciaio cromato
- 2 piedini di livellamento in altezza
- Dimensioni: 100x50x220 cm
- Dim. imballo: 123x53x15 cm
- Peso: 35,7 / 37,7 kg

- 5 perforated panels, 96x35 cm, round holes
- 3 shelves: 96.8x35 cm
- 20 hooks in chromed steel
- 2 x height leveling feet
- Dimensions: 100x50x220 cm
- Packing size: 123x53x15 cm
- Weight: 35.7 / 37.7 kg

- 5 paneles perforados, 96x35 cm, agujeros redondos
- 3 estantes: 96.8x35 cm
- 20 ganchos en acero cromado
- 2 x pies niveladores de altura
- Dimensiones: 100x50x220 cm
- Tamaño del embalaje: 123x53x15 cm
- Peso: 35,7 / 37,7 kg

Cod. 05.088.136

€ 498,00



**ARMADIO CON PANNELLI FORATI PORTAUTENSILI  
CABINET WITH TOOL HOLDER PERFORATED PANELS  
ARMARIO CON PANELES PERFORADOS PORTAHERRAMIENTAS**

- 5 pannelli forati 96x35 cm, fori tondi
- 3 ripiani: 92,6x30 cm
- 2 faretti LED 3W, presa Schuko
- 20 ganci in acciaio cromato
- 2 maniglie x sportello, serratura inclusa
- 2 piedini di livellamento in altezza
- Dimensioni: 100x50x220 cm
- Dim. imballo: 1) 123x53x15, 2)100x48x28, 3)177x50x13 cm
- Peso: 35,7 / 37,7 kg

- 5 pcs perforated panels 96x35 cm, round holes
- 3 pcs shelves: 92,6x30 cm
- 2pcs. 3W LED spotlight, Schuko power plug
- 20 pcs chrome plate steel hooks
- 2pcs door handle, incl.lock
- 2 pcs height levelling feet
- Dimensions: 100x50x220 cm
- Packaging: 1) 123x53x15, 2)100x48x28, 3)177x50x13 cm
- Weight: 35,7/37,7 kg

- 5 paneles perforados 96x35 cm, agujeros redondos
- 3 baldas: 92,6x30 cm
- 2 luz LED 3W, enchufe de alimentación Schuko
- 20 ganchos en acero cromado
- 2 manijas de puerta, cerradura incluida
- 2 pies niveladores de altura
- Dimensiones: 100x50x220 cm
- Tamaño del embalaje: 1) 123x53x15, 2) 100x48x28, 3) 177x50x13 cm
- Peso: 35,7 / 37,7 kg

ARREDO PER OFFICINA • WORKSHOP FURNITURE • MUEBLES DE TALLER

Cod. 05.088.127 € 1.744,00



THE BEST FUNCTIONAL AND COST SAVING RATIO ON LOGISTICS COSTS. IDEAL FOR SMALL/MEDIUM WORKSHOPS AND FOR ONLINE SALES.

LA MEJOR RELACIÓN FUNCIONAL Y DE AHORRO EN COSTES LOGÍSTICOS IDEAL PARA TALLERES PEQUEÑOS/MEDIANOS Y PARA VENTAS ONLINE

Disponibile solo in colore nero-grigio RAL 7011 / in black-grey RAL 7011 color available only

SET DI 172 UTENSILI CON SUPPORTI IN GOMMA NON INCLUSI NEL COD. 05.088.127  
SET OF 172 TOOLS WITH RUBBER SUPPORTS NOT INCLUDED IN COD. 05.088.127

Cod. 05.088.138.R1 € 244,00

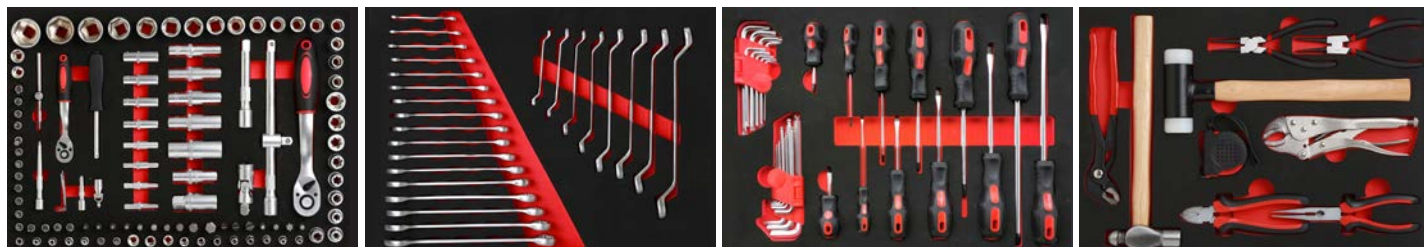

SERIE DI GANCI E SUPPORTI PER PANNELLI FORATI. Prezzi/quantità a richiesta  
PEGBOARD HOOKS FOR TOOLS. Prices/quantity on request

GANCIO DOPPIO / 2 SHORT PIN HOOK / DOBLE GANCHO



Cod. 05.088.131/25 € 1,60

Cod. 05.088.131/50 € 1,60

Cod. 05.088.131/75 € 1,80

Cod. 05.088.131/100 € 1,80

Cod. 05.088.131/150 € 2,00

Cod. 05.088.131/200 € 2,00

Cod. 05.088.132 € 3,50

SUPPORTO PER BUSSOLE  
HOLDER FOR SOCKETS  
SOPORTE DE BRÚJULA













Cod. 05.088.133 € 6,90

SUPPORTO PER CACCIAVITI  
HOLDER FOR SCREWDRIVERS  
SOPORTE PARA DESTORNILLADORES





COMPOSIZIONE ARREDO PER OFFICINA •  
WORKSHOP FURNITURE COMPOSITION • COMPOSICIÓN MUEBLES DE TALLER

 <p>762x458x1830mm</p>	<p><b>05.088.127.R1</b> € <b>560,00</b></p> <ul style="list-style-type: none"> <li>armadio a due porte, 3 ripiani</li> <li>chiusura centrale con chiave e due magneti, struttura saldata</li> <li>4 piedi regolabili in altezza</li> <li>two-door cabinet, 3 shelves</li> <li>central locking with key and two magnets</li> <li>4 feet adjustable in height</li> </ul>	 <p>610x406x758mm</p>	<p>Carrello vuoto 6 cassetti 6 Ripiani in gomma 15 mm inclusi Empty trolley 6 drawers 6 EVA 15 mm included</p>
 <p>610x280x338mm</p>	<ul style="list-style-type: none"> <li>pensile con anta basculante con ammortizzatore</li> <li>wall unit with tilting door with shock absorber</li> </ul>		<p>8 ganci / supporti inclusi 8 hooks / holders included</p>
 <p>610x406x758mm</p>	<ul style="list-style-type: none"> <li>armadietto inferiore a 2 ante</li> <li>un ripiano (0,7mm)</li> <li>chiusura centrale con chiave a due magneti</li> <li>4 piedi regolabili in altezza</li> <li>lower cabinet with 2 doors</li> <li>one shelf (0,7mm)</li> <li>central locking with two-magnet key.</li> <li>4 height adjustable feet</li> </ul>	 <p>610x280x338mm</p>	<p>6 pannelli forati porta utensili Foro quadrato: 10x10mm, Distanza tra i fori: 38x38 mm 6 perforated tool panels Square hole: 10x10mm, Hole spacing: 38x38mm</p>
 <p>610x406x758mm</p>	<ul style="list-style-type: none"> <li>cassettiera a 4 cassetti</li> <li>guide su cuscinetti</li> <li>maniglie in alluminio,</li> <li>4 piedi regolabili in altezza</li> <li>ripiani in gomma 15 mm incl.</li> <li>chest of 4 drawers</li> <li>guides on bearings</li> <li>Aluminum handles</li> <li>4 feet adjustable in height</li> <li>15 mm EVA incl.</li> </ul>	 <p>610x324x24mm</p>	<p>Ripiano superiore aperto Upper open shelf</p>
		 <p>1830x406x25mm</p>	<p>1 piano di lavoro in acciaio inox 1 worktop in stainless steel</p>
			<p>4 barre di fissaggio 1750x60mm 4 fixing bars 1750x60mm</p>

IL MIGLIOR RAPPORTO FUNZIONALE E SALVA COSTI DI LOGISTICA  
IDEALE PER PICCOLE/MEDIE OFFICINE E PER LA VENDITA ONLINE



PALLET 1

855 x 500 x 1840mm  
165 kg

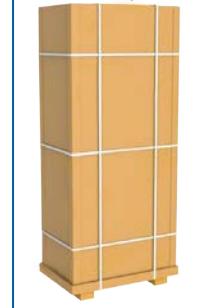

PALLET 2

625 x 420 x 770mm  
50 kg



ARREDO PER OFFICINA • WORKSHOP FURNITURE • MUEBLES DE TALLER

**NEW!**

Cod. 05.088.142

€ 1.369,00

SET DI 107 UTENSILI INCLUSO  
SET OF 107 TOOLS INCLUDED



**BUDGET**

Disponibile solo in colore rosso-nero  
Available only in black-red color

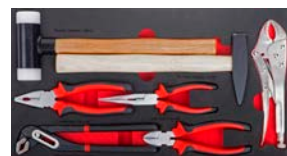

1. Armadio a due porte, 3 ripiani, con 4 piedini regolabili
2. Carrello estraibile con 4 cassetti, completo di 4 eva supporti con 107 utensili (pagina 2)
3. Carrello estraibile con 1 cassetto e 2 sportelli
4. Piano in legno multistrato, tavolo con 4 piedini regolabili
5. 6 pannelli forati portautensili
6. 2 sportelli con anta apribile
7. 2 ripiani porta oggetti

1. Two-door cabinet , 3 shelves, 4 feet adjustable in height
2. 4 drawers trolley with 107 tools on 4 eva supports included (page 2)
3. 2 doors trolley with 1 drawer
4. Plywood workbench, 4 feet adjustable in height
5. 6 perforated tool panels
6. 2 wall cabinets with door
7. 2 shelves

**Dimensioni / dimensions:**

1. 760x495x1960 (2056,5 with foot) mm
2. 616,5x330,3x800,4 mm
3. 616,5x330,3x800,4 mm
4. 1600x500x826,5 (863 with foot) mm
5. 398x19,5x600 mm
6. 400x198x600 mm
7. 798x20x178 mm

**1 PALLET**

525 x 790 x 2090mm  
Net/gross: 124/141 kg

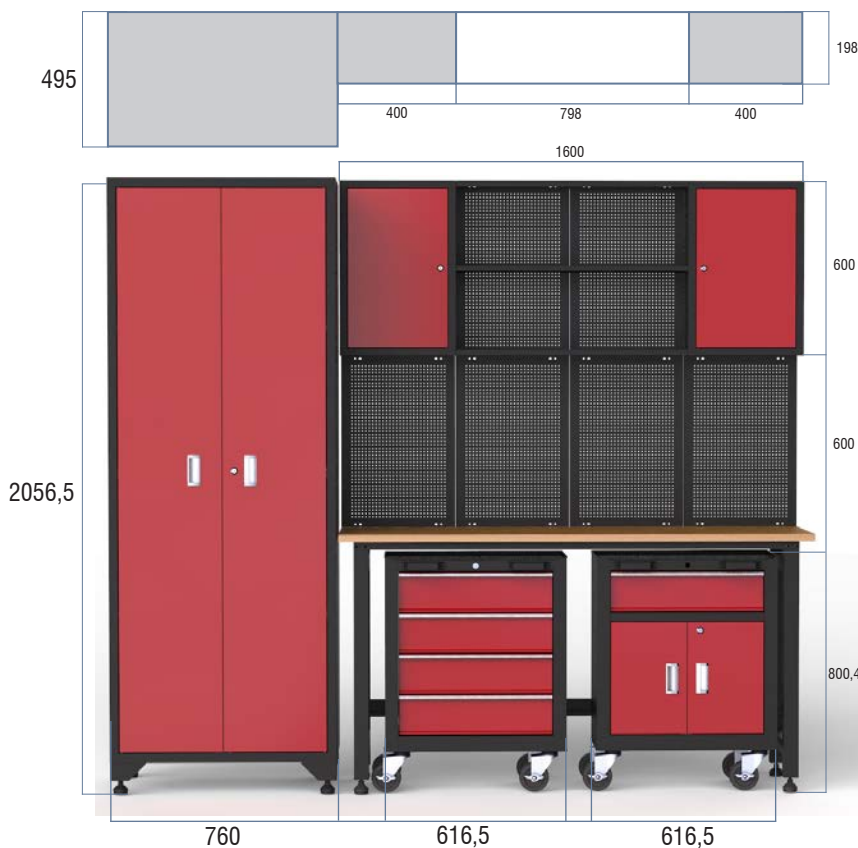

PROMO 2022/2

SET DI 107 UTENISLI CON SUPPORTI IN GOMMA INCLUSI NEL KIT 05.088.142  
 SET OF 107 TOOLS WITH RUBBER SUPPORTS INCLUDED IN KIT 05.088.142

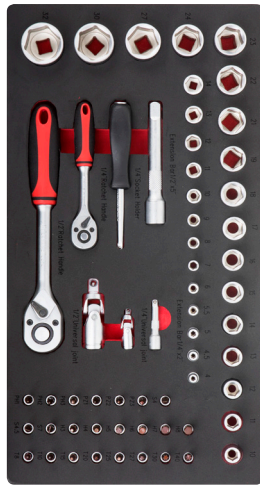
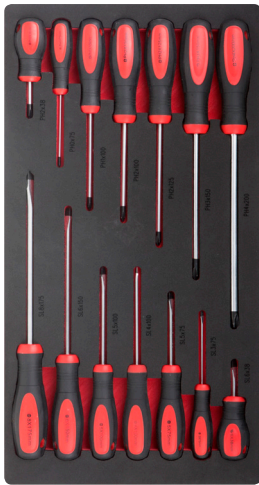

1° cassetto 1st Tray	14 pz/pcs	7pcs	SL Cacciavite / Screwdriver	SL 6*38MM-8*175MM-3*75-6*150MM-5*75-4*100MM-5*100MM
2° cassetto 2nd Tray	60 pz/pcs	7Pcs	PH Cacciavite / Screwdriver	PH0*75-PH1*100MM-PH2*100-PH2*125-PH3*150--PH2*38-PH4*200
		17Pcs	1/2" Socket	10-11-12-13-14-15-16-17-18-19-21-22-23-24-27-30-32MM
		1Pcs	1/2" giunto universale	1/2"universal joint
		1Pcs	1/2" barra di estensione	1/2" extension Bar-125MM
		1Pcs	1/2" manico a cricchetto	1/2"ratchet Handle -72T
		13Pcs	1/4" Socket	4-4.5-5-5.5-6-7-8-9-10-11-12-13-14MM
		1Pcs	1/4" giunto universale	1/4"universal joint
		1Pcs	1/4" barra di estensione	1/4" extension bar: 50mm
		1Pcs	1/4" manico a cricchetto	1/4"ratchet Handle -72T
		1Pcs	1/4" supporto per presa Manico a girante	1/4"Socket Holder/Spinder handle
3° cassetto 3rd Tray	26 pz/pcs	23pcs	1/4" presa a bussola Socket Bit	T8-10-15-20-25-27-30-40-PH1-2-3,PZ1-2-3,SL4-4.5-7,H3-4-5-6-7-8
		17pcs	6-22mm chiave combinata Combination Wrench	6-7-8-9-10-11-12-13-14-15-16-17-18-19-20-21-22mm
		9Pcs	Set di chiavi esagonali a sfera	Ball Point Hex Key sets 1.5-2-2.5-3-4-5-6-8-10MM
4° cassetto 4th Tray	7 pz/pcs	1Pcs	40mm martello di gomma	40mm Rubber Mallet
		1Pcs	500g martello da macchinista	500g Machinist Hammer
		1Pcs	8" pinze combinate	Combination Pliers
		1Pcs	8" pinza a becchi lunghi	Long nose Plies
		1Pcs	7" pinze diagonali	Diagonal Pliers
		1Pcs	10" pinze di bloccaggio	Locking Pliers
		1Pcs	10" pinza per giunti scanalati	D4 Groove joint Pliers



PROMO 2022/2

Cod. 05.088.128

€ 112,00

**SET DI 3 CONTENITORI PORTA TUTTO IN TELAIO DI ALLUMINIO**  
per lavoro - tempo libero - sport

**SET OF 3 STORAGE BOXES IN ALUMINUM FRAME**  
for work - leisure - sport

**JUEGO DE 3 CAJAS DE ALMACENAMIENTO CON ESTRUCTURA DE ALUMINIO**  
para el trabajo - tiempo libre - deporte

- Materiale: alluminio - ABS - 3,9mm MDF + 2mm EVA
- Piccolo: 47,5x26x21 cm
- Medio: 68x31x32 cm
- Grande: 73x38x36 cm
- Non vendibili separatamente
- Dimensioni imballo: 76,5x41x41 cm / peso: 12,7 kg

- Material: aluminum - ABS - 3,9mm MDF + 2mm EVA
- Small: 47.5x26x21 cm
- Medium: 68x31x32 cm
- Large: 73x38x36 cm
- Not for separate sale
- Packaging dimensions: 76.5x41x41 cm / weight: 12.7 kg

- Material: aluminio - ABS - MDF de 3,9 mm + EVA de 2 mm
- Pequeño: 47,5x26x21 cm
- Mediano: 68x31x32 cm
- Grande: 73x38x36 cm
- No para venta separada
- Dimensiones del embalaje: 76,5x41x41 cm / peso: 12,7 kg



Cod. 05.088.137

€ 598,00

**SET DI 3 CONTENITORI IN ALLUMINIO AD ALTA RESISTENZA**  
ideali per i settori autocarro/edilizia/idraulica/cantieri

**SET OF 3 HIGH RESISTANCE ALUMINUM CONTAINERS**  
suitable for the truck / construction / hydraulics / worksites sector

**JUEGO DE 3 CONTENEDORES DE ALUMINIO DE ALTA RESISTENCIA**  
adecuado para los sectores de camiones / construcción / hidráulica / lugares de trabajo

- Medio: 76,5x35,3x25,4 cm; 5,5 kg
- Grande: 123x38x38 cm; 12 kg
- Extra grande: 145x52x46 cm; 19 kg
- Dimensioni imballo 3 in one: 147x54x48 cm / peso: 41 kg

- Medium: 76.5x35.3x25.4 cm; 5.5 kg
- Large: 123x38x38 cm; 12 kg
- Extra Large: 145x52x46 cm; 19 kg
- 3 in one packaging dimensions: 147x54x48 cm / weight: 41 kg

- Medio: 76,5x35,3x25,4 cm; 5,5 kg
- Grande: 123x38x38 cm; 12 kg
- Extra grande: 145x52x46 cm; 19 kg
- Dimensiones embalaje 3 en uno: 147x54x48 cm / peso: 41 kg



① Cod. 05.088.137.R2 € 121,00

② Cod. 05.088.137.R3 € 209,00

③ Cod. 05.088.137.R4 € 369,00

Cod. 03.036.36

€ 210,00

VASCA RACCOGLI OLIO IN PLASTICA  
OIL COLLECTION PLASTIC TANK  
TANQUE EN PLÁSTICO PARA LA RECOGIDA DE ACEITE

- Robusta struttura in polietilene
- Stoccaggio salvaspazio
- Piano in polietilene rimovibile
- Con valvola di scarico
- Dimensioni: 130x68x30cm
- Peso 22 kg

- Sturdy polyethylene structure
- Space-saving storage
- Removable polyethylene top
- With drain valve
- Dimensions: 130x68x30cm
- Weight 22 kg

- Robusta estructura de polietileno
- Almacenamiento que ahorra espacio
- Tapa de polietileno extraíble
- Con válvula de drenaje
- Dimensiones: 130x68x30cm
- Peso 22 kilogramos



MAX. 20 PZ IMPILABILI  
MAX. 20 STACKABLE PCS



Cod. 05.088.70

€ 20,90

- 450x80x320 mm



Cod. 05.088.69

€ 16,34

- 360x65x280 mm

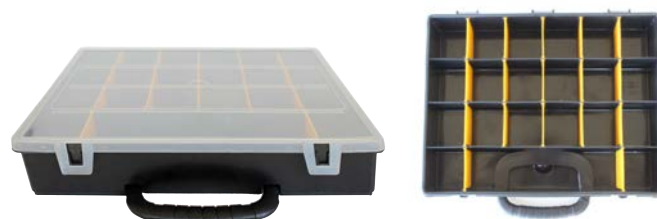

Cod. 05.083.03

€ 43,70

SGABELLO REGOLABILE CON PORTAUTENSILI  
ADJUSTABLE STOOL WITH TOOL-HOLDER  
TABURETE AJUSTABLE CON PORTAHERRAMIENTAS

- Portata / Capacity / Capacidad: 130Kg
- Altezza max / Max. height / Longitud max: 540mm
- Altezza min / min. height / Longitud min.: 420mm



Cod. 05.083.02

€ 26,40

SGABELLO FISSO CON QUATTRO RUOTE E PORTA UTENSILI  
STOOL WITH FOUR WHEELS AND TOOLS-HOLDER  
TABURETE CON CUATRO RUEDAS Y PORTA-HERRAMIENTAS

- Weight / Peso: 3,8kgs
- Dim: 360x365x365mm



Cod. 05.084.25

€ 94,00

**SUPPORTO TELESCOPICO A VITE CON PEDALE**  
TELESCOPIC MECHANICAL SUPPORT WITH PEDAL  
SOPORTE MECANICO TELESCOPICO CON PEDAL

Ideale per tutti i lavori dove è necessario un sostegno aggiuntivo.

- Lunghezza: min. 1360 - max. 2030 mm
- Capacità massima: 750kgs
- Peso: 18,3 lordi, 15,3 netti
- Dimensioni imballo: 141x37x6,5cm

**Ideal for all works when extra support is needed**

- Length: min 1360 – max 2030mm
- Max capacity: 750kgs
- Weight: 18,3 gross, 15,3 net
- Packaging dimensions: 141x37x6,5cm

**Ideal para todos los trabajos donde se necesita soporte adicional.**

- Longitud: min. 1360 - max. 2030mm
- Capacidad máxima: 750kgs
- Peso: 18,3 bruto, 15,3 neto
- Dimensiones del embalaje: 141x37x6,5cm

Cod. 05.085.11

€ 94,00

**DISPOSITIVO DI TRASPORTO FUSTI OLIO FINO A 350KGS**  
DEVICE FOR TRANSPORTING OIL DRUMS UP TO 350KGS  
DISPOSITIVO PARA EL TRANSPORTE DE BARRILES DE ACEITE HASTA 350KGS



**Per il trasporto facile e sicuro di fusti da 210lt; è utilizzabile con gru e/o carrelli elevatori da officina**

- Capacità di carico: 350kgs
- Peso netto/lordo: 9,5/11,5kgs
- Dimensioni imballo: 490x260x210mm

**For an easy and safe transportation of 210lt drums; it can be used with cranes or forklift trucks for mechanic garages**

- Load capacity: 350kgs
- Net/gross weight: 9,5/11,5kgs
- Packing dimensions: 490x260x210mm

**Para un transporte sencillo y seguro de los barriles de 210lt; puede ser utilizado con grúas o montacargas para talleres mecánicos**

- Capacidad de carga: 350kgs
- Peso bruto/neto: 9,5/11,5kgs
- Dimensiones embalaje: 490x260x210mm

Cod. 05.084.05P

€ 194,00

**SOLLEVATORE IDRAULICO DA FOSSA CON COMANDO A PEDALE**

Fornito con supporto a croce a quattro braccia (A) e supporto inclinabile per allineamento cambi e differenziali (B)

**HYDRAULIC TRANSMISSION JACK WITH FOOT CONTROL**

Supplied with a 4-arms crosswise support (A) and adjustable support for the alignment of gearboxes and differentials (B)

**GATO HIDRAULICO PARA TRANSMISIONES CON CONTROL DE PEDAL**

Se suministra con un soporte de 4 brazos en cruz (A) y soporte ajustable para la alineación de cajas de cambio y diferenciales (B)

**DATI TECNICI:**

- Capacità: 500 Kg
- Pompa a pedale
- Valvola limitatrice di carico
- Altezza max : 1990 mm
- Altezza min 1140

**TECHNICAL FEATURES:**

- Capacity: 500 Kg
- Foot pump
- Overload safety valve
- Max height: 1990mm
- Min. height: 1140mm

**DATOS TÉCNICOS:**

- Capacidad: 500kgs
- Bomba de pie
- Válvula de seguridad de sobrecarga
- Altura máx.: 1990mm
- Altura min.: 1140mm

**DOPPIA CULLA**  
**INTERCAMBIABILE**  
**(A+B)**

**INTERCHANGEABLE**  
**DOUBLE CRADLE**  
**(A + B)**

**CUNA DOBLE**  
**INTERCAMBIABLE**  
**(A + B)**



Cod. 05.084.26

€ 224,00

CRICCO A CARRELLO 5 T A DOPPIO PISTONE  
5 TONS TROLLEY JACK, DOUBLE PISTON  
GATO CON RUEDAS 5 T, PISTON DOBLE

**Dati tecnici:**

- Portata: 5 ton
- Altezza min: 100 mm
- Altezza max: 533 mm
- Peso netto: 44 kg
- Dimensioni: 710x310x235 mm

**Technical features:**

- Capacity: 5 ton
- Min. height: 100 mm
- Max. height: 533 mm
- Net weight: 44kg
- Dimensions: 710x310x235 mm

**Datos técnicos:**

- Capacidad: 5 ton
- Altura min.: 100 mm
- Altura max.: 533 mm
- Peso neto: 44kg
- Dimensiones: 710x310x235 mm



Cod. 05.084.02L

€ 155,00

CRICCO A CARRELLO 3 T A DOPPIO PISTONE  
3 TONS TROLLEY JACK WITH DOUBLE PISTONS  
GATO CON RUEDAS 3 T, PISTON DOBLE

**Dati tecnici:**

- Portata: 3 ton
- Altezza min: 80 mm
- Altezza max: 495 mm
- Peso netto: 37 kg
- Dimensioni: 640x342x174 mm

**Technical features:**

- Capacity: 3 ton
- Min. height: 80 mm
- Max. height: 495 mm
- Net weight: 37 kg
- Dimensions: 640x342x174 mm

**Datos técnicos:**

- Capacidad: 3 ton
- Altura min.: 80 mm
- Altura max.: 495 mm
- Peso neto: 37 kg
- Dimensiones: 640x342x174 mm



PROMO 2022/2

CRICCHI A BOTTIGLIA • BOTTLE JACKS • GATOS DE BOTELLA

<p>CRICCHI IDRAULICI HYDRAULIC JACKS GATOS HIDRAULICOS</p>					
	<b>Cod. 05.084.12</b>	<b>Cod. 05.084.13</b>	<b>Cod. 05.084.14</b>	<b>Cod. 05.084.16</b>	<b>Cod. 05.084.15</b>
<p>↓ Capacità Capacity Capacidad</p>	<b>6 tons</b>	<b>10 tons</b>	<b>16 tons</b>	<b>20 tons</b>	<b>32 tons</b>
<p>Altezza min. Min. height Altura min.</p>	185 mm	200 mm	225 mm	235	280 mm
<p>Alzata Riser Alzamiento</p>	110 mm	125 mm	140 mm	145	180 mm
<p>Regolazione altezza Height adjustment Ajuste altura</p>	60 mm	60 mm	60 mm	60 mm	--
<p>Prezzo promo Promo price</p>	<b>€ 20,00</b>	<b>€ 28,00</b>	<b>€ 39,00</b>	<b>€ 48,00</b>	<b>€ 92,00</b>

**Cod. 05.084.07** € **128,00**

**CRICCO A BOTTIGLIA A COMANDO PNEUMATICO**

Ideale come kit soccorso per autocarri.  
Può essere usato anche manualmente con leva

**PNEUMATIC BOTTLE JACK**

Ideal as aid kit for trucks, it may be used also by hand with a lever

**GATO DE BOTELLA CON FUNCIONAMIENTO NEUMÁTICO**

Ideal como kit de ayuda para camiones, puede ser utilizado también por mano con una palanca



- Capacità: 20 T
- Altezza min.: 210 mm
- Altezza max.: 340 mm
- Alzata max.: 130 mm
- Range pressione aria 0,8 – 0,95Mpa
- Dimensione del piano di appoggio: 165 x 224 mm
- Dim. Imballo: 260 x 210 x 230 mm
- Peso netto/lordo: 13,5/13,9 kg

- Capacity: 20 T
- Min. height: 210 mm
- Max. height: 340 mm
- Lifting altitude: 130 mm
- Air Pressure Range: 0,8 – 0,95Mpa
- Base size: 165 x 224 mm
- Packaging dim.: 260 x 210 x 230 mm
- Net/gross weight: 13,5/13,9 kgs

**Cod. 05.084.17** € **185,00**

- Capacità: 35 T
- Altezza min.: 250 mm
- Altezza max.: 408 mm
- Alzata max.: 160 mm
- Range pressione aria 0,8 – 1 Mpa
- Dimensione del piano di appoggio: 150 x 226 mm
- Dim. Imballo: 230x290x280mm
- Peso netto/lordo: 21/22 kg

- Capacity: 35 T
- Min. height: 250 mm
- Max. height: 408 mm
- Lifting altitude: 160 mm
- Base size: 150 x 226 mm
- Air Pressure Range: 0,8 – 1 Mpa
- Packaging dim.: 230x290x280mm
- Net/gross weight: 21/22 kgs

**Cod. 05.085.01** € **35,30**

**COPIA DI CAVALLETTI DA 3T  
COUPLE OF 3T JACK STANDS  
GATOS DE 3T**

- Altezza/height/altura max: **428 mm**
- Altezza/height/altura min: **298 mm**
- Peso/weight: 7,5 kgs



**Cod. 05.085.00** € **53,00**

**COPIA DI CAVALLETTI DA 6T  
COUPLE OF 6T JACK STANDS  
GATOS DE 6T**

- Altezza/height/altura max: **610 mm**
- Altezza/height/altura min: **400 mm**
- Peso/weight: 14,6 kgs





AVVIATORI D'EMERGENZA • JUMP STARTERS • ARRANCADOR DE EMERGENCIA

HYBRID PACK



SUPERCUP HYBRID 12V

SMART LINE



F4000-2



HAPPY TANK 2



HAPPY VAN 2

CLASSIC LINE



F3000 12V



HAPPY TIR 12/24V

BUDGET LINE



BOCIA EVO 12V



HAPPY TRACTOR EVO 12V



BOCIA EVO 12/24V

PROMO 2022/2

AVVIATORI D'EMERGENZA • JUMP STARTERS • ARRANCADOR DE EMERGENCIA

HYBRID PACK LINE

Cod. 03.020.10

€ 429,00

SUPERCAP HYBRID 12V

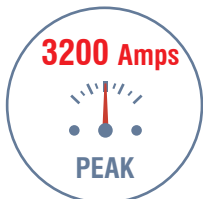
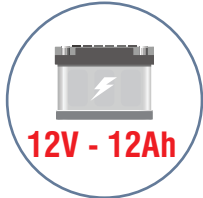

I SUPERCAPACITOR (o supercondensatori) accumulano rapidamente una grande quantità di energia necessaria per l'avviamento, assorbendola direttamente dalla batteria del veicolo da avviare. Se la batteria del veicolo è completamente scarica, la batteria ausiliaria del booster permette ai supercapacitori di ricaricarsi e di effettuare l'avviamento.

SUPERCAPACITORS quickly accumulate a large amount of energy needed for the jump start, taking it directly from the battery of the vehicle to start. If the battery of the vehicle is completely discharged, the booster's auxiliary battery allows supercapacitors to recharge and to jump start the vehicle.



CLASSIC LINE • TRADITIONAL AGM POWER PACK

Cod. 03.015.00

€ 252,00

F3000 12V

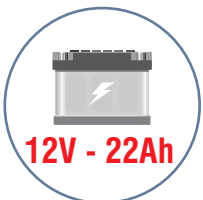

MADE IN ITALY

Cod. 03.018.01

€ 896,00

HAPPY TIR 12/24V



Cod. 05.088.03

€ 33,00

Carrello/Trolley

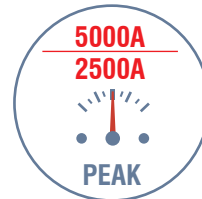
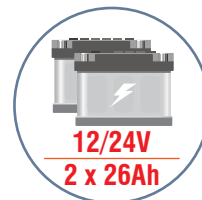

MADE IN ITALY



AVVIATORI D'EMERGENZA • JUMP STARTERS • ARRANCADOR DE EMERGENCIA

SMART PACK LINE

Cod. 03.015.11 € 559,00 **F4000-2 12/24V**

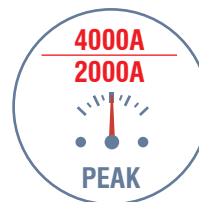
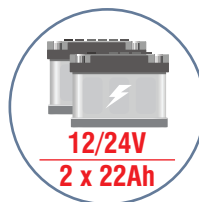

Cod. 03.016.02 € 319,00 **HAPPY VAN 2 12V**

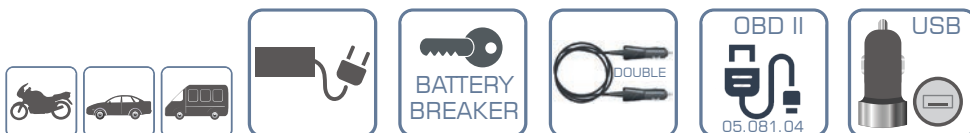
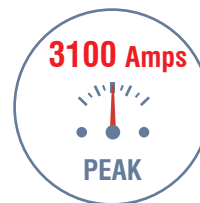
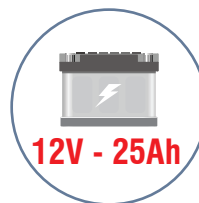

Cod. 05.081.04 € 16,00

**OBD II**

- CAVO OBD II Presa accendisigari per booster (solo 12V)
- OBD II CABLE cigarette lighter socket for booster (only 12V)
- CABLE OBD II toma encendedor de cigarillos para arrancador (sólo 12V)



Cod. 05.081.05 € 16,00

**OBD**

- CAVO OBD
- OBD CABLE
- CABLE OBD



PROMO 2022/2

AVVIATORE D'EMERGENZA • JUMP STARTER • ARRANCADOR DE EMERGENCIA

SMART PACK LINE

Cod. 03.019.02

€ 1.050,00 **HAPPY TANK 12/24V**

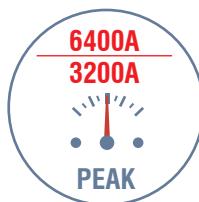
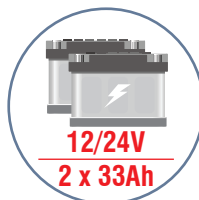

• **VOLTMETRO DIGITALE (1)**  
Questo display consente ai professionisti di vedere rapidamente la tensione disponibile e di testare l'alternatore di un veicolo

• **INTERRUTTORE 12-24V (2)**  
Questo interruttore facile da usare consente di cambiare il booster da 12 a 24 V

• **ALLARME DI INVERSIONE DI POLARITÀ (3)**  
Questo avviso acustico e visivo informa l'operatore dell'errato collegamento dei terminali

- Diametro cavo (mm<sup>2</sup>): 50
- Lunghezza cavo (cm): 175
- Dimensione (cm): 39 x 27 x 53
- Peso: 33 kg

• **DIGITAL VOLTMETER**  
This display allows professionals to quickly see the voltage available and to test the alternator of a vehicle

• **12-24V SWITCH**  
This easy to use switch allows the booster to be changed from 12 to 24V.

• **REVERSE POLARITY ALARM**  
This audible and visual alert informs professionals of incorrect terminal connections

- Cable Diameter (mm<sup>2</sup>): 50
- Cable length (cm): 175
- Dimensions (cm): 39x27x53
- Weight: 33 kg



AVVIATORI D'EMERGENZA • JUMP STARTERS • ARRANCADOR DE EMERGENCIA

BUDGET LINE

BUDGET

Cod. 03.015.03

€ 172,00

### BOCIA EVO 12V

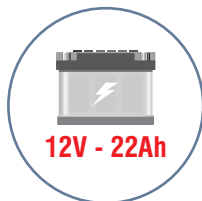

- Pinze con contatto in bronzo con treccia interna
- Controllo stato di carica (sotto carica)
- Controllo stato di carica (a riposo)
- Stacca batteria con allarme polarità invertita
- Carica batterie 1 Amp 100/240V idoneo per la ricarica dell'avviatore (non adatto per la ricarica della batteria dell'autovettura)
- **Nuova batteria 12V 22Ah / 2000A peak**

- Pliers with bronze contact and internal braid
- Charge indicator (under charge)
- Charge indicator (not under charge)
- Battery switch with reverse polarity alarm
- Battery charger 1 Amp 100/240V for recharging the booster (not suitable for recharging the car battery)
- **New battery 12V 22Ah /2000A Peak**

Cod. 03.017.01

€ 328,00

### HAPPY TRACTOR EVO 12V

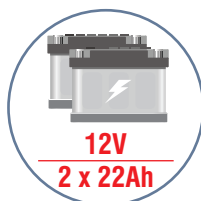

- Voltmetro
- Stacca batteria
- Luce a led di emergenza
- Pinze con contatto in bronzo con treccia interna
- Caricabatteria 4 Amp 100/240V idoneo per la ricarica dell'avviatore (non adatto per la ricarica della batteria dell'autovettura)
- **Nuove batterie 2pzx12V 22Ah / 4000A Picco - 12V**

- Voltmeter
- Battery switch
- Emergency led light
- Pliers with bronze contact and internal braid
- Battery charger 4 Amp 100/240V for recharging the booster (not suitable for recharging the car battery)
- **New batteries 2pcs x 12V 22Ah / 4000A Peak - 12V**

Cod. 03.015.04

€ 379,00

### BOCIA EVO 12/24V

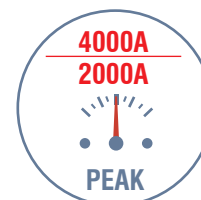
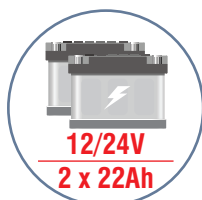

- Voltmetro
- Stacca batteria
- Luce a led di emergenza
- Pinze con contatto in bronzo con treccia interna
- Caricabatteria 4 Amp 100/240V, idoneo per la ricarica dell'avviatore (non adatto per la ricarica della batteria dell'autovettura)
- Commutatore 12V-0-24V
- **Nuove batterie 2pz x 12 V 22Ah/ 4000A Picco - 12V, 2000A Picco - 24V**

- Voltmeter
- Battery switch
- Emergency led light
- Pliers with bronze contact and internal braid
- Battery charger 4 Amp 100/240V for recharging the booster (not suitable for recharging the car battery)
- Switch 12V-0-24
- **New batteries 2pcs x 12V 22Ah/ 4000A Peak - 12V, 2000A Peak - 24V**

									
	HYBRID	CLASSIC LINE		SMART LINE			BUDGET LINE		
Corredo standard Standard outfits	SUPERCUP	F3000	HAPPY TIR	HAPPY VAN 2	F4000-2	HAPPY TANK 2	BOCIA EVO 12V	HAPPY TRACTOR EVO	BOCIA EVO 12/24V
	03.020.10	03.015.00	03.018.01	03.016.02	03.015.11	03.019.02	03.015.03	03.017.01	03.015.04
Voltaggio	12V	12V	12/24V	12V	12/24V	12/24V	12V	12V	12/24V
Capacità batterie (Ampere/picco) Battery capacity (Ampere/Peak)	12Ah + SUPERCUP 3900A	22Ah 2000A	2x26Ah 5000/ 2500A	26Ah 3100A	2x22Ah 4000/ 2000A	2x33Ah 6400/ 3200A	22Ah 2000A	2x22Ah 4000A	2x22Ah 4000/ 2000A
Allarme elettronico contro inversione di polarità Electronic alarm to avoid polarity inversion	—	—	—	✓	✓	✓	✓	✓	✓
Protezione circuito do carica	✓	✓	✓	✓	✓	✓	✓	✓	✓
Presca accendisigari	✓	✓	—	✓	✓	✓	✓	✓	✓
Lunghezza cavi, mm	110	150	200	120	150	180	100	150	150
Sezione cavi	25	25	50	35	50	50	25	25	25
Voltmetro	led	led	digit	led	digit	digit	led	analog	analog
Presca USB	—	✓	—	✓	✓	✓	✓	✓	✓
Cavo doppio accendisigari Double cigarette lighter Cod. 03.024.35		✓	—	✓	✓	✓	✓	✓	✓
Cavo OBDII con presca accendisigari OBDII with cigarette lighter socket Cod. 05.081.04		✓	—	✓	✓	✓	option	option	option
Caricabatterie Battery charger	03.024.30 SMART 200 	03.024.34B CBA 400 PRO 	03.024.36B CBA LEM 	03.016.02.R1 	03.015.11.R2 	03.015.11.R2 	03.015.03.R1 	03.015.04.R1 	03.015.04.R1 
Dimensioni, cm / peso, kg	32x16x45 8kg	27x19x25 11,5kg	43x52x48 34kg	34x24x48 14kg	32x33x48 26 kg	45x30x65 35 kg	41x17x41 11 kg	47x30x45 20 kg	47x30x45 20 kg
Prezzo promo: Promo price:	€ 429,00	€ 252,00	€ 896,00	€ 319,00	€ 559,00	€ 1.050,00	€ 172,00	€ 328,00	€ 379,00

**PINZE PROFESSIONALI 1000A** isolate per batterie auto/camion

**PROFESSIONAL PLIERS 1000A** insulated for batteries of cars and trucks

**Cod. 05.100.00**

> Pinza nera  
> Black plier

€ 11,00

**Cod. 05.100.01**

> Pinza rossa  
> Red plier

€ 11,00

- Completamente isolata
- Terminali in bronzo (maggiore superficie di contatto sul polo batteria)
- Ampia apertura: max. 35mm
- Treccia in rame
- Minimo ingombro

- Fully insulated
- Terminals of bronze (bigger contact surface on the battery pole)
- Great opening: max. 35mm
- Copper braid
- Space-saving





**EV CHARGING POINT**  
STAZIONI DI RICARICA DA PARETE PER VETTURE ELETTRICHE  
WALL CHARGING STATIONS FOR ELECTRIC VEHICLES

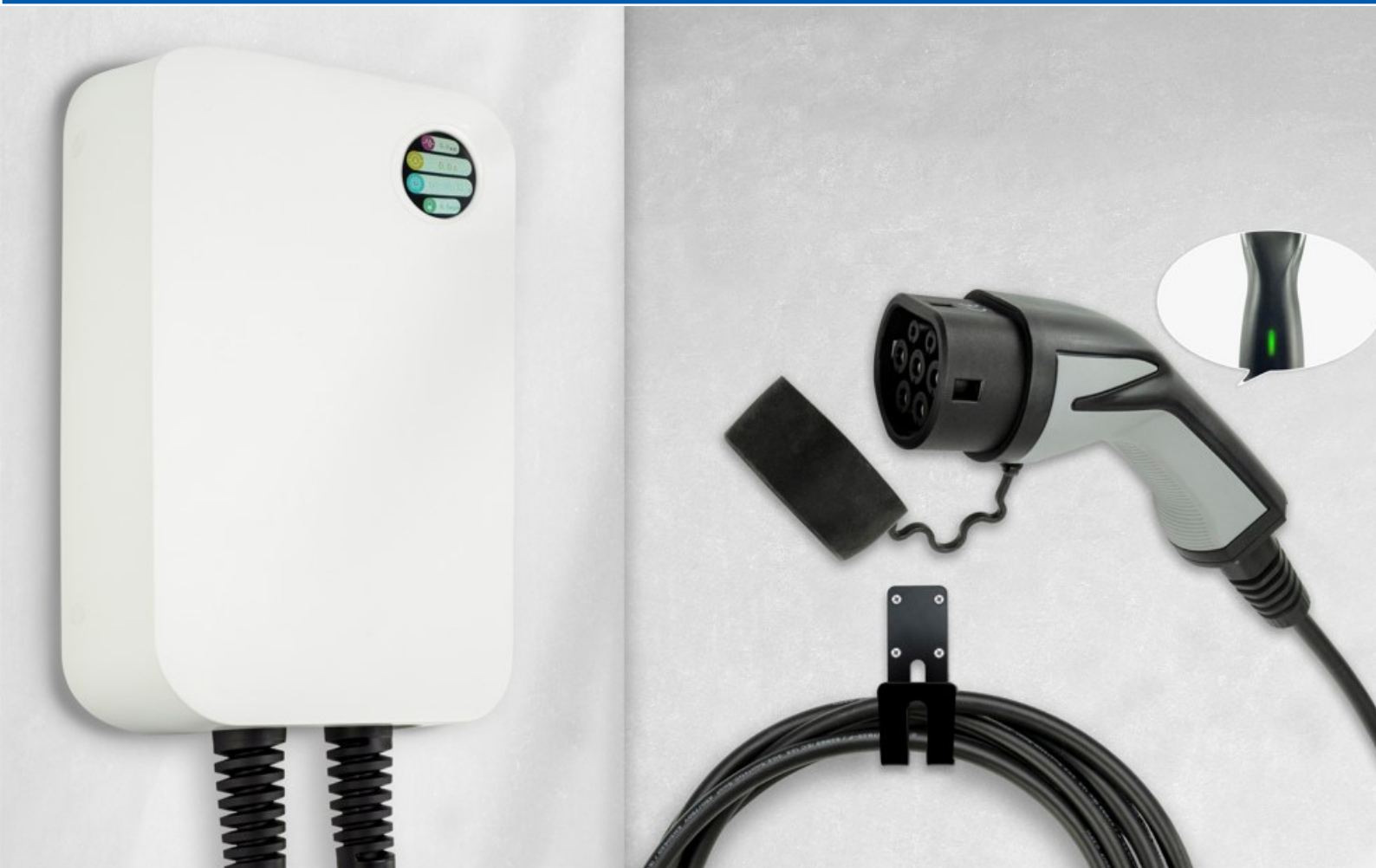

**STAZIONI DI RICARICA DA PARETE PER VETTURE ELETTRICHE**  
**WALL CHARGING STATION FOR ELECTRIC VEHICLES**

**11 kW / 16A**

Cod. 03.024.40

€ **690,00**

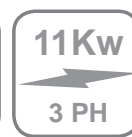
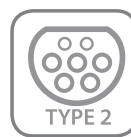

**22 kW / 32A**

Cod. 03.024.41

€ **750,00**

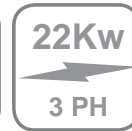
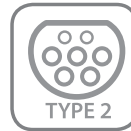

- Alimentazione: 230 V/400 V AC (trifase)
- Frequenza: 50 Hz/60 Hz
- Max . potenza di uscita: 11kW/22kW (trifase)
- Max . corrente: 16A/32A
- Lunghezza cavo: 6 m
- Dimensioni: 43x25.5x26cm (11kW) / 69x35x15.5cm (22 kW)
- Dimensioni imballo: 53x44.5x55.5cm (11 kW) / 71x72x34.5cm (22 kW)

- Power supply: 230V/400V AC (three phase)
- Frequency: 50Hz/60Hz
- Max. output power: 11kW/22kW (three phase)
- Max. input current: 16A/32A
- Cable: 6 m
- Dimensions: 43x25.5x26cm (11kW) / 69x35x15.5cm (22 kW)
- Packaging dim.: 53x44.5x55.5cm (11 kW) / 71x72x34.5cm (22 kW)

- Fuente de alimentación: 230V/400V AC (trifásica)
- Frecuencia: 50Hz/60Hz
- Potencia de salida máx.: 11kW/22kW (trifásico)
- Corriente de entrada máxima: 16A/32A
- Cabo: 6m
- Dimensiones: 43x25,5x26cm (11kW) / 69x35x15,5cm (22kW)
- Dimensiones del embalaje: 53x44,5x55,5cm (11kW) / 71x72x34,5cm (22kW)

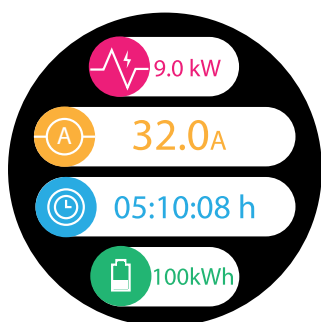

PROMO 2022/2



## EV CHARGING POINT

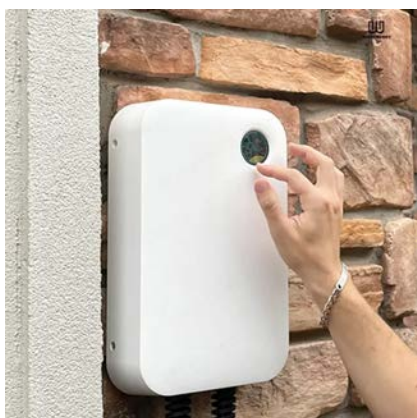

- Adatto per i parcheggi di aree residenziali, centri commerciali e uffici
- Facile da installare, stabile nelle prestazioni
- Schermo touch screen a colori LCD è in grado di mostrare lo stato di carica dettagliato
- Indicatore luminoso a LED
- Regolazione intelligente della potenza
- Protezione da sovratensione
- Protezione da sottotensione
- Protezione da sovraccarico
- Protezione da cortocircuito
- Protezione isolamento
- Messa a terra
- Protezione da sovratemperatura
- Protezione contro i fulmini

- Suitable for the ground and parking lot of residential areas, shopping malls and office places
- Easy to install, stable in performance
- The LCD color touch screen is able to show the detailed charging status and it can be operated directly
- LED Indicator light
- Intelligent power adjustment
- Over-voltage protection
- Under-voltage protection
- Overload protection
- Short circuit protection
- Leakage Protection
- Ground protection
- Over temperature protection
- Lightning protection

- Suitable for the ground and parking lot of residential areas, shopping malls and office places
- Easy to install, stable in performance
- The LCD color touch screen is able to show the detailed charging status and it can be operated directly
- LED Indicator light
- Intelligent power adjustment
- Over-voltage protection
- Under-voltage protection
- Overload protection
- Short circuit protection
- Leakage Protection
- Ground protection
- Over temperature protection
- Lightning protection

Cod. 03.024.38

€ 322,00

NEW!

**CARICABATTERIE PORTATILE MODALITÀ 2 EV (10/13/16A 1 FASE 3,6KW) CON CONNETTORE TIPO 2 DA 5 M****MODE 2 EV CHARGING CABLE (10/13/16A 1 PHASE 3.6KW) WITH 16FT/5M TYPE 2 CONNECTOR**

Questo caricabatteria è particolarmente utilizzato per la ricarica lenta di veicoli elettrici, dotati di attacco "plug in" di tipo 2 alla presa di casa.

This battery charger is particularly used for electric vehicle charging, equipped with a Type 2 plug, suitable for the household socket.

**CARATTERISTICHE TECNICHE**

- Alimentazione/Tensione: 230V ± 10% AC Monofase
- Corrente/Frequenza: 16A 50/60Hz
- Spina: SCHUKO/CEE/UK/NEMA/NZ
- Corrente nominale: 10/13/16 A commutabile
- Potenza nominale: max. 3,6 KW
- Connettore: tipo 2
- Lunghezza cavo: 5 m
- Indicatore a LED
- Grado di protezione: IP66
- Protezione dagli urti: IK10
- Valigia di trasporto inclusa

**Protezione elettrica:**

- Protezione da sovracorrente
- Protezione da corrente residua
- Protezione di messa a terra
- Protezione da sovra/sottotensione
- Protezione da sovra/sotto frequenza
- Protezione da sovra/sottotemperatura
- Certificazione: EN62752
- Temperatura: da -30°C a +50°C
- Umidità: 5%-95%
- Altitudine: <2000 m
- Peso netto/peso lordo: 2,5 kg/ 2,8 kg

**TECHNICAL FEATURES**

- Power Supply/Voltage: 230V ± 10% AC Single phase
- Current/ Frequency: 16A 50/60Hz
- Plug: SCHUKO/CEE/UK/NEMA/NZ
- Rated Current: 10/13/16A Switchable
- Rated Power: Max. 3.6KW
- Connector: Type 2
- Cable Length: 5m
- LED Indicator Light
- Protection degree: IP66
- Impact Protection: IK10
- Transport case included

**Electrical Protection:**

- Over current protection
- Residual current protection
- Ground protection
- Over/Under voltage protection
- Over/Under frequency protection
- Over/Under temperature protection
- Certification standard: EN62752
- Temperature range: -30°C to +50°C
- Humidity range: 5%-95%
- Altitude range: <2000m
- Net Weight/ Gross Weight: 2.5kg/ 2.8kg

Cod. 03.036.01

€ 1.141,00

**RECUPERATORE CARBURANTI (BENZINA/GASOLIO) 90 LT**  
**90 LT FUEL (PETROL/DIESEL) RECOVERY DEVICE**  
**RECUPERADOR DE COMBUSTIBLES (GASOLINA/GASÓLEO), 90 LT**

- Capacità: 90lt
  - Serbatoio carrellato in acciaio inox
  - Funzionamento con sistema Venturi (A)
  - Aspira e scarica il carburante in pochi minuti
  - Dispositivo per recupero vapori (B)
  - Dimensioni: 530x530x1100mm
  - Peso 28.3 kg
- 
- Capacity: 90lt
  - 90lt Stainlesssteel tank with trolley
  - Functioning with Venturi system (A)
  - It drains and discharges the fuel in a few minutes
  - Device to recover vapours (B)
  - Dimensions: 530x530x1100mm
  - Weight: 28.3 kg
- 
- Capacidad: 90lt
  - Depósito de acero inoxidable 90lt con carro
  - Funcionamiento con sistema Venturi (A)
  - Drena y descarga el combustible en pocos minutos.
  - Dispositivo para recuperar vapores (B)
  - Dimensiones: 530x530x1100 mm
  - Peso: 28,3 kg



Cod. 03.036.38

€ 269,00



**UNITÀ DI ASPIRAZIONE OLIO MOTORE**

*pneumatica, carrellata, con sonde di aspirazione, connettore di raccolta sottoponte, completo di pre-camera*

**MOTOR OIL SUCTION UNIT**

*Pneumatic, on trolley, with suction probes, under bridge connector for collection, complete with pre-chamber*

**DATI TECNICI:**

- Serbatoio: 80 lt
- Pre-camera graduata: 8lt
- Dimensioni: 400x400x1300mm
- Peso: 35 kg
- Pressione aria: 1÷2 bar

**TECHNICAL FEATURES:**

- Tank: 80 lt
- Graduated pre-chamber: 8lt
- Dimensions: 400x400x1300mm
- Weight: 35 kg
- Air pressure: 1÷2 bar

Cod. 03.036.26

€ 119,00

**SCARICATORE PER OLIO ESAUSTO**  
**WASTE OIL DRAINER**  
**ESCURRIDOR DE ACEITE USADO**



**DATI TECNICI:**

- Capacità serbatoio: 70 lt
- Capacità imbuto: 10 lt
- Altezza: 1,65 mt
- Alimentazione: aria compressa
- Pressione max per scarico olio: 1 bar
- Dimensioni imballo: 50 x 44 x 96 cm

**TECHNICAL FEATURES:**

- Tank capacity: 70 lt
- Funnel capacity: 10 lt
- Height: 1.65 mt
- Powered by compressed air
- Max. oil drain pressure: 1 bar
- Packaging dimensions: 50 x 44 x 96 cm

**DATOS TÉCNICOS:**

- Capacidad del tanque: 70 lt
- Capacidad de embudo: 10 lt.
- Altura: 1,65 mt
- Accionado por el aire comprimido
- Max. presión de drenaje de aceite: 1 bar
- Dimensiones del embalaje: 50 x 44 x 96 cm

Cod. 03.031.32LT

€ 728,00

**PRESSA PNEUMO-IDRAULICA DA 30 TON**

per officine meccaniche auto, moto, macchine agricole, manutenzione industriale

**30 TONS AIR HYDRAULIC PRESS**

for mechanical workshops for auto, moto, agricultural machines, industrial maintenance

- Capacità: 30 tonnellate
- Corsa pistone: 160mm
- Avanzamento max 6 mm a colpo
- Velocità di discesa <30mm/s
- Min. distanza operativa: 130mm
- Max. distanza operativa: 820mm
- Pompa pneumo-idraulica, con comando anche manuale
- Pistone mobile
- **A:** Coppia piastre in acciaio con intaglio a "V"
- Dimensioni imballo: 1750x380x270mm (pressa smontata)
- Peso netto/lordo: 150/160kg
- Dimensioni pressa montata: 590x770x1760mm
- Capacity: 30 tons
- Piston stroke: 160mm
- Feed max 6 mm per stroke
- Descent speed <30mm/s
- Min. working distance: 130mm
- Max. working distance: 820mm
- Air hydraulic pump, with handle
- Moving piston
- **A:** Pair of steel plates with V-carving
- Package dimensions: 1750x380x270mm (pressa smontata)
- Net/gross weight: 150/160kg
- Dim. assembled press: 590x770x1760mm

**I particolari che fanno la differenza**

**B:** Pistone mobile, manometro incassato nel corpo della macchina

**C:** Pompa pneumo-idraulica e comando manuale con leva

**The details that make the difference**

**B:** Mobile piston, pressure gauge built-in in the body of the machine

**C:** Air hydraulic pump and manual control with lever

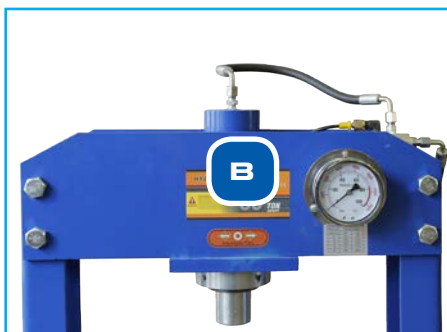
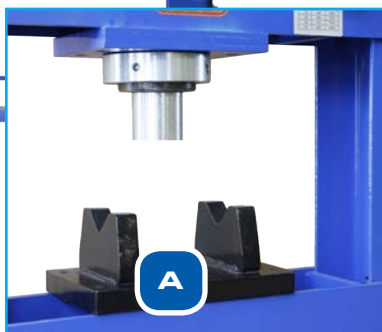

CORREDO A RICHIESTA • OPTIONAL EQUIPMENT • BAJO PEDIDO

Cod. 03.031.33

€ 178,00



**SERIE DI 6 PUNZONI IN ACCIAIO C40**  
per estrazione cuscinetti/boccole

**SET OF 6 PUNCHES IN C40 STEEL**  
for removing bearings/bushings



**PIASTRONE**  
per smontaggio cuscinetti/boccole

**LARGE PLATE**  
for removing bearings/bushings



**FLANGE ESTRATTRICI**  
2 coppie: Ø35-50mm / Ø50-75mm

**EXTRACTING FLANGES**  
2 pairs: Ø35-50mm / Ø50-75mm

Cod. 03.031.36

€ 26,00

**COMANDO A PEDALE PER PRESSA 03.031.32LT**  
**FOOT CONTROL FOR PRESS 03.031.32LT**  
**CONTROL DE PIE PARA PRENSA 03.031.32LT**



Foto indicativa / Indicative picture

Cod. 05.084.04

€ 86,70

**CAPRETTA SOLLEVAMENTO MOTORI**  
**ENGINE LIFTING CRANE**  
**SOPORTE DE ELEVACIÓN DEL MOTOR**



- Portata: 500kgs
- Capacity: 500kgs
- Capacidad: 500kgs
- Agganci regolabili:
- Supports adjustment:
- Ajuste apoyos:
- 1100 ÷ 1600mm
- 1100 ÷ 1600mm
- 1100 ÷ 1600mm
- Peso: 22kgs
- Weight: 22kgs
- Peso: 22kgs

Cod. 05.085.08COMBI

€ 248,00

**GRU SMONTABILE DA OFFICINA**  
**DISMOUNTABLE CRANE FOR MECHANIC WORKSHOPS**  
**GRUA DESMONTABLE PARA TALLER MECANICO**



- Capacità: 1 ton
- Misure: 1620mmx930x1600hmm
- Dimensioni imballo: 800x860x1600mm
- Peso: 76kgs
- Particolarità: pistone a doppio effetto, include traversa con catene e traslatore cod. 05.085.13

- Capacity: 1 ton
- Measures: 1620mmx930x1600hmm
- Dimensions (packed): 800x860x1600mm
- Weight: 76kgs
- Special feature: double effect piston, includes the lifting bar with chains and side-shift system cod. 05.085.13

- Capacidad: 1 ton
- Medidas: 1620mmx930x1600mm
- Dimensiones embalaje: 800x860x1600mm
- Weight: 76kgs
- Special feature: double effect piston, includes the lifting bar with chains and side-shift system cod. 05.085.13

Cod. 05.085.13

€ 33,00



Traversa sollevamento motori con catene e traslatore  
Motor lifting bar with chains and side-shift system  
Barra de elevación para motor con cadenas y sistema de movimiento lateral

Cod. 05.085.12

€ 156,00

**CAVALLETTO SOSTEGNO MOTORE**  
**ENGINE SUPPORT STAND**  
**SOPORTE FRONTAL PARA MOTORES**

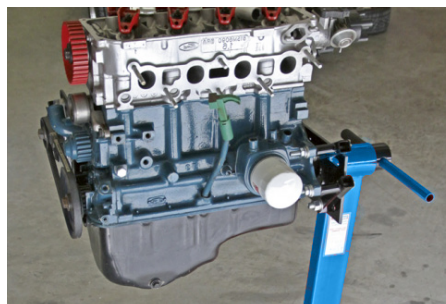

- Capacità = 550 kg
- Equipaggiato con 6 ruote
- Altezza dal suolo: 80 cm
- Piatto di fissaggio: 250x150x12 mm
- Peso: 36 kg

- Load capacity = 550 kg
- 6 wheels for maximum stability
- Height from the floor: 80 cm
- Fixing plate: 250x150x12 mm
- Weight: 36 kg

- Capacidad de carga = 550 kg
- 6 ruedas para máxima estabilidad
- Altura desde el suelo: 80 cm
- Placa de fijación: 250x150x12 mm
- Peso: 36 kg

Cod. 05.083.04 € 26,00

**CARRELLO PORTA ATTREZZI DA PAVIMENTO SU RUOTE, CON PIANO MAGNETICO**  
**FLOOR TOOL-HOLDER ON WHEELS, WITH MAGNETIC TOP**  
**PORTAHERRAMIENTAS DE SUELO SOBRE RUEDAS, CON SUPERFICIE MAGNÉTICA**

- Dimensioni: 468mm
- Altezza: 110mm
- Capacità: 100kg
- Peso: 1,4 kg
- Imballo: 47x47x6mm

- Dimensions: 468mm
- Height: 110mm
- Capacity: 100kg
- Weight: 1.4 kg
- Imballo: 47x47x6mm

- Dimensiones: 468 mm
- Altura: 110 mm
- Capacidad: 100 kg
- Peso: 1,4 kilogramos
- Embalaje: 47x47x6mm

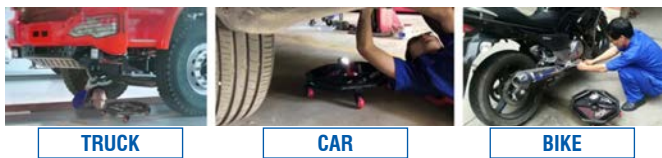

TRUCK

CAR

BIKE

Cod. 05.087.06 € 115,00

**CARRELLO SPOSTAMENTO VETTURE INCIDENTATE**  
**HYDRAULIC VEHICLE POSITIONING JACK**  
**SOPORTE MOVIL PARA COCHES AVERIADOS**



**Dati tecnici:**

- Capacità: 600 kg
- Max/Min apertura: 650 ÷ 300mm
- Peso: 19 kg

**Technical features:**

- Capacity: 600 kg
- Max/min width: 650 ÷ 300mm
- Weight: 19 kg

**Datos técnicos:**

- Capacidad: 600Kgs
- Ancho Max/Min: 650 ÷ 300Mm
- Peso: 19Kgs



Cod. 05.084.22 € 299,00

**CRICCO A CARRELLO 3 T IN ALLUMINIO PORTATILE**  
*ideale per show room e soccorso su strada*

**3 T TROLLEY JACK, FULL ALUMINIUM PORTABLE**  
*ideal for showrooms and roadside assistance*

**GATO CON RUEDAS 3 T DE ALUMINIO PORTÁTIL**  
*ideal para salas de exposición y asistencia en carretera*

**Dati tecnici:**

- Maniglia di trasporto
- Doppio pistone per sollevamento veloce
- Profilo basso
- Capacità: 3 ton
- Altezza min: 98mm
- Altezza max: 480mm
- Dimensioni prodotto: 730x320x180mm
- Dimensioni imballo: 785x380x215mm
- Peso netto/Peso lordo: 24,4/26,5kg

**Technical features:**

- Easy carrying
- Fast lifting dual pump
- Low profile
- Capacity: 3 ton
- Min. Height: 98mm
- Max. Height: 480mm
- Product size: 730x320x180mm
- Package size: 785x380x215mm
- Net Weight/Gross Weight: 24,4/26,5kg



FINE SERIE  
SELL OUT

PROMO 2022/2

Cod. 05.073.35

€ 99,00

**AVVOLGICAVO ELETTRICO AUTOMATICO 15+1 MT**  
**15+1 MT ELECTRIC AUTOMATIC HOSE REEL**



- Cursore passacavo traslante (foto A)
- Arresto e rilascio automatico
- Pulsante di ritengo posizione cavo (foto B)
- Cavo 3x1,5mm<sup>2</sup>, L=15 mt+1
- Tensione: 230V
- Max. potenza: 2200W
- Dimensioni: 295x165x330mm
- Peso: 4,5 kg
- Cable slider (foto A)
- Automatic stop and spring rewind
- Cable position block button (foto B)
- Cable 3x1,5mm<sup>2</sup>, L=15 mt+1
- Voltage: 230V
- Max. power: 2200W
- Dimensions: 295x165x330mm
- Weight: 4,5 kg

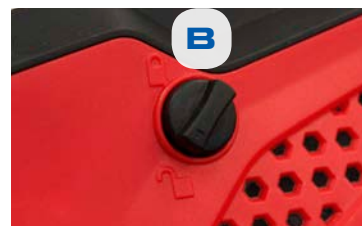
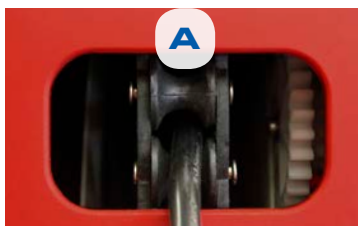

Cod. 05.073.42

€ 52,00

**AVVOLGITUBO AUTOMATICO PER ARIA COMPRESSA**  
**AUTOMATIC HOSE REEL FOR COMPRESSED AIR**



- **L=10+1,5 mt**, Tubo in PVC
- ø 8 /12 mm
- Attacchi 1/4" BSPT
- Max. pressione: 10 bar
- Pulsante di blocco
- Dimensioni: 29x16,5x33 cm
- Peso: 4,3 kg

- **L = 10 + 1mt**, tubo in PVC
- ø 8/12 mm
- 1/4" BSPT connections
- Max. Pressure: 10 bar
- Lock button
- Dimensions: 29x16,5x33 cm
- Weight: 4.3 kg

Cod. 05.073.44

€ 53,00

**AVVOLGITUBO PER IMPIANTI ACQUA**  
**WATER HOSE REEL**



- Tubo in PVC per acqua
- **L=10+1 mt**
- ø 8 /12 mm
- Attacchi 3/4"
- Max. pressione: 10 bar
- Pulsante di blocco
- Dimensioni: 30,5x17,5x35 cm
- Peso: 4,2 kg

- **PVC hose for water**
- **L = 10 + 1 mt**
- ø 8/12 mm
- 3/4 "connections
- Max. Pressure: 10 bar
- Dimensions: 30.5x17.5x35 cm
- Weight: 4.2 kg

Cod. 05.073.43

€ 87,00

**AVVOLGITUBO AUTOMATICO PER ARIA COMPRESSA**  
**AUTOMATIC HOSE REEL FOR COMPRESSED AIR**



- **L=15+2mt**, tubo in PVC
- ø 9,5 /15,5 mm
- Attacchi 1/4" BSPT
- Pressione di lavoro: 17 bar
- Autobloccante di emergenza e riavvolgimento controllato (guida di scorrimento)
- Fissaggio a muro
- Dimensioni: 45x23,5x42,4 cm
- Peso: 8,7 kg

- **L = 15 + 2mt**, PVC hose
- ø 9.5 / 15.5 mm
- 1/4" BSPT connections
- Working pressure: **17 bar**
- Emergency self-locking and controlled rewinding (sliding guide)
- Wall fixing
- Dimensions: 45x23,5x42,4 cm
- Weight: 8,7 kg

Cod. 05.073.45

€ 72,00

**AVVOLGITUBO PER IMPIANTI ACQUA**  
**WATER HOSE REEL**



- Tubo in PVC per acqua
- **L=15+1,5 mt**
- ø 1/2"
- Attacchi 3/4"
- Max. pressione: 10 bar
- Autobloccante in qualsiasi posizione e riavvolgimento controllato
- Fissaggio a muro
- Dimensioni: 30,5x17,5x35 cm
- Peso: 4,2 kg

- **PVC hose for water**
- **L = 15 + 1,5mt**
- ø 1/2"
- 3/4 "connections
- Max. Pressure: **10 bar**
- Self-locking and controlled rewinding
- Wall fixing
- Dimensions: 30.5x17.5x35 cm
- Weight: 4.2 kg

Cod. 05.075.16

€ 1.290,00

420 L  
INDUSTRIAL

**SABBIATRICE INDUSTRIALE**

con aspiratore a ciclone 420 lt con apertura superiore

**PNEUMATIC SANDBLASTER**

with 420 lts cyclone vacuum, with top opening door

**ARENADORA INDUSTRIAL**

de 420 lt con aspirador a ciclón con apertura superior



- Comando a pedali
- L'aspiratore a ciclone assicura una estrazione di polvere e sabbia in continuo
- L'illuminazione interna (alogeno)
- Apertura ampia per l'introduzione dei pezzi
- Regolatore di pressione
- Dimensioni esterne: 1210x610x1700 mm
- Dimensioni camera interna: 1200x600x370/600 mm
- Dimensioni porta accesso: 1000x570cm
- Dimetro ugello: 6,7 mm
- Consumo d'aria: 630 lt/min
- Aspiratore elettrico: 1.200W
- Pressione di lavoro: 3,5 ÷ 5,5 bar
- Max. pressione ammessa: 8 bar
- Alimentazione: 230 V 50H7

**ACCESSORI STANDARD:**

- 4 ugelli
- 1 pistola sabbiatrice (industriale)
- 2 lampade alogene
- 5 protezioni per luce interna
- 2 nastri a rullo
- 1 nastro a rullo teflon
- 1 contenitore a ciclone
- 1 comando a pedale
- 1 separatore acqua-aria

- Foot pedal operated
- The cyclonic vacuum assures the continuous extraction of the dust and the sand
- Inner lighting (halogen)
- Large opening for the insertion of the components
- Pressure regulator
- External dimensions: 1210x610x1700mm
- Blasting cabinet size: 1200x600x370/600mm
- Opening door size: 1000x570cm
- Nozzle size: 6,7 mm
- Air consumption: 630 lt/min
- Vacuum generator: 1.200W
- Operating pressure: 3,5 ÷ 5,5 bar
- Max. pressure: 8 bar
- Voltage: 230 V 50H7

**STANDARD EQUIPMENT:**

- 4 ceramic nozzles
- 1 sand blasting gun (industrial)
- 2 halogen lamps for the inner lighting
- 5 safety films for the inner lighting
- 2 rolls of sealant tape
- 1 roll teflon sealant
- Cyclone tank
- Control pedal
- 1 water-separator

Cod. 05.075.10

€ 382,00

**SABBIATRICE PNEUMATICA  
PNEUMATIC SANDBLASTER  
ARENADORA NEUMATICA**

- Pressione d'ingresso: 2,8 ÷ 5,6bar (40-80 PSI)
- Consumo d'aria: 450 ÷ 550 lt/min
- Dimensioni camera: 596x838x625mm
- Dimensioni imballo: 96x62x62,5cm
- Peso netto/lordo: 48/51kg
- Predisposizione per aspiratore (non fornito)

**ACCESSORI STANDARD:**

- Coppia guanti L=60cm
- Set ugelli pistola
- Pistola sabbiatrice



220 L

Cod. 05.075.30

€ 152,00

**SABBIATRICE DA BANCO, 90 LT  
90 LT TABLE SANDBLASTER  
ARENADORA DE BANCO, 90 LT**



- Cabinet in acciaio resistente con porta superiore
- Capacità della sabbia nell'imbuto: 6.5 L
- Consumo d'aria: 240/300 lt/min
- Spazio di lavoro: 580x480x350 mm
- Capacità compressore d'aria: 40-120 PSI
- Tensione di uscita: 12V; Potenza: 8W
- Dimensione imballo: 630x550x225 mm

- Heavy duty steel cabinet with upper door
- Sand capacity in the funnel: 6.5 L
- Air consumption: 240/300 lt/min
- Work space: 580x480x350 mm
- Air compressor capacity: 40-120 PSI
- Output voltage: 12V; Power: 8W
- Packaging size: 630x550x225 mm

Cod. 05.075.31.R1

Prezzo a richiesta  
Price on request



**ADATTATORE PER ASPIRAPOLVERE  
ESTERNO per sabbiatrici 05.075.10  
/ 05.075.30  
ADAPTER FOR DUST ASPIRATOR  
for the sandblasters  
05.075.10 / 05.075.30**

- Inlet pressure: 2.8 ÷ 5.6bar (40-80 PSI)
- Air consumption: 450 ÷ 550 lt/min
- Chamber size: 596x838x625mm
- Package dimensions: 96x62x62,5cm
- Net/gross weight: 48/51kg
- Predisposition for aspirator (not supplied)

**STANDARD ACCESSORIES:**

- Pair of gloves L=60cm
- Set nozzles for gun
- Gun for sandblaster



Cod. 05.075.17

€ 422,00

105 L



**SABBIATRICE CARRELLATA** con aspiratore incorporato da 105 lt  
**105 LT SANDBLASTER WITH WHEELS** with built-in vacuum device  
**ARENADORA CON RUEDAS** con aspirador incluido, 105 lt

- Aspiratore incorporato
- Consente l'uso continuo dell'apparecchio
- Recupera le parti di abrasivo separandole dalla polvere
- Può essere usato su pietra e superfici metalliche
- Pressione aria compressa: 8 bar
- Consumo di aria: 170÷640 lt/min (a seconda dell'uso)
- **A:** Aspiratore da 1200W
- **B:** Spazzola
- Connessione aria: 1/2"
- Capacità serbatoio: 105lt, 1041x367(Ø)mm
- Peso netto/lordo: 36kg /40 kg
- Built-in vacuum
- it allows continuous work
- recovers abrasive parts separating them from dust
- It can be used on stone or metallic surfaces
- Compressed air pressure: 8 bar
- Air consumption: 170÷640 lt/min (depending on use)
- **A:** 1200W Vacuum device
- **B:** Brush
- Air connection: 1/2"
- Tank size: 105lt 1041x367(Ø)mm
- Net/gross: 36kg /40 kg
- Aspirador incorporado
- Permite el uso del dispositivo
- Recupera partes de abrasivo separandolas de polvo
- Puede ser utilizada sobre piedras y superficies metálicas
- Max presión aire comprimido: 8 bar
- Consumo de air: 170÷640 lt/min (depende del uso)
- **A:** Aspirador de: 1200W
- **B:** Cepillo
- Conesió de aire: 1/2"
- Capacidad de el tanque: 105lt 1041x367(Ø)mm
- Peso neto/bruto: 36kg /40 kg

Cod. 05.075.18

Prezzo a richiesta  
Price on request

75 L



**SABBIATRICE CARRELLATA** da esterno 75 lt  
**75 LT PORTABLE SANDBLASTER**, for external use  
**ARENADORA CON RUEDAS** para uso externo 75lt



- L'aria e l'abrasivo sono miscelati nel serbatoio
- La miscela aria+abrasivo viene accelerata dall'ugello conico amplificando l'effetto sabbiante
- Capacità serbatoio: 75 lt
- Consumo d'aria: 170-710 lt/min
- Pressione di lavoro: 6 ÷ 10 bar
- Dimensioni esterne: 920x780x380mm
- Dimensioni imballo: 880x460x420mm
- The air and the sand are mixed in the tank with compressed air
- The mixture speeds up at the cone shaped nozzle in the hose, amplifying the effectivity of the blasting process
- Tank capacity: 75lt
- Air consumption: 170-710 lt/min
- Operating pressure: 6 ÷ 10 bar
- Total size: 920x780x380mm
- Packaging size: 880x460x420mm
- Aire y abrasivo son mezclados en el tanque
- La mezcla aire+abrasivo es acelerada por las boquillas cónicas ampliando el efecto de arena
- Capacidad de el tanque: 75 lt
- Consumo de aire: 170-710 lt/min
- Presión de trabajo: 6 ÷ 10 bar
- Dimensiones exteriores: 920x780x380mm
- Dimensiones del embalaje: 880x460x420mm

RICAMBI SABBIATRICI / SANDBLASTERS SPARE PARTS / RECAMBIO ARENADORAS

<b>Ricambi sabbiatrici</b> Sandblasters spare parts Recambios arenadoras	 Cod. 05.075.16	 Cod. 05.075.10	 Cod. 05.075.17	 Cod. 05.075.18
<b>Set ugelli</b> Set of nozzles Juego de boquillas para pistola	 Cod. 05.075.22 € 11,00	 Cod. 05.075.11 € 4,80	 Cod. 05.075.26 € 4,60	 Cod. 05.075.24 € 4,60
<b>Pistola sabbiatrica</b> Blasting gun Pistola para arenadora	 Cod. 05.075.23 € 38,00	 Cod. 05.075.13 € 19,00	 Cod. 05.075.28 € 13,50	 Cod. 05.075.29 € 13,50
<b>Coppia guanti</b> Pair of gloves Par de guantes	 Cod. 05.075.12 € 31,00	 Cod. 05.075.12 € 31,00	Tubo 2,5 mt per sabbiatrica cod. 05.075.18 2,5mt hose for sandblaster cod. 05.075.18 Tubo 2,5mt para arenadora cod. 05.075.18 Cod. 05.075.25 € 14,00	

MATERIALE DI CONSUMO  
CONSUMABLES

Cod. 05.075.14 € 52,00

**Corindone 80 grana per sabbiatrica. Sacco da 25kg**  
Corundum 80 micron for the sandblaster, 25kg bag  
Corindón 80 gr para arenadora Saco 25 kg

Cod. 05.075.15 € 52,00

**Corindone 60 grana per sabbiatrica. Sacco da 25kg**  
Corundum 60 micron for the sandblaster, 25kg bag  
Corindón 60 gr para arenadora Saco 25 kg

Cod. 05.075.27 € 56,00

**Microsfere, grana 40/70 micron, sacco da 25kg**  
Micro glass beads, grain size 40/70 micron, 25kg bag  
Microesferas, grano 40/70 micras, saco 25 kg

Cod. 04.003.14

€ 260,00

**BT1000**



Anche per batterie «start-stop»  
Also for «start-stop» batteries  
También para baterías «start-stop»

**TESTER BATTERIE/ALTERNATORI**  
con stampante e codice a barre

**DIGITAL BATTERY/CHARGING STARTING SYSTEM TESTER**  
with printer and barcode

- **Applicazione:** Batteria 6V e 12V / Test batteria START-STOP 12V,
- Test del sistema 12V e 24V: test avviamento / test ricarica
- test IR
- Contatore numero di test (Test counter) per garanzie e controllo qualità
- Codice a barre per rintracciabilità batterie (code 39) indispensabile per gestione garanzie
- Cavi di test sostituibili in caso di danneggiamento
- Dimensioni: 251x130x45
- Accessori: guscio antiurto, rotolo carta, 6 batterie 1.5
- 6 lingue: IT/EN/FR/D/ES/PT
- **Application:** 6V & 12V battery / 12V START-STOP battery test
- System Test: 12V & 24V Starter Test/Charging Test
- IR test
- Test counter for warranty or quality control
- Bar code for the battery traceability (code 39) indispensable for warranty management
- Replaceable test cables in case of damage
- Dimensions: 251x130x45
- Accessories: shock-proof case, paper roll, 6 batteries 1.5
- 6 languages: IT/EN/FR/D/ES/PT

SET CAPACITY:  
590CCA/SAE

Operating Range  
40~2,000 CCA(SAE)

BATTERY TYPE:  
AGM FLAT PLATE

Battery Type:  
a. Regular Liquid  
b. AGM Flat Plate  
c. AGM Spiral  
d. VRLA/GEL

SELECT RATING:  
CCA/SAE

Norme / Global Battery Rating:  
SAE(CCA), EN, IEC, DIN, JIS (Battery No.)

GOOD & RECHARGE  
VOL: 12.11V  
CCA: 152CCA/SAE  
IR: 16.22mΩ

SOH (State of Health)  
SOC (State of Charge)

BAD & REPLACE  
VOL: 12.12V  
CCA: 159CCA/SAE  
IR: 15.46mΩ

5 Test Results:  
a. Good & Pass  
b. Good & Recharge  
c. Recharge & Retest  
d. Bad & Replace  
e. Bad Cell & Replace

Cod. 04.003.12

€ 198,00

**BT 900**

- Applicazioni: 12V batterie lead acid, AGM, EFB, GEL, URLA 12/24V test alternatori
- Display: 4 linee alfanumerico
- Campo di misura: 40 : 2000 CCA (SAE)
- Dimensioni: 235x102x68mm
- Funzioni speciali: batterie START/STOP, stampante, test su vettura in moto
- 6 lingue: EN, FR, D, ES, IT, PT
- Applications: 12V lead acid batteries, AGM, EFB, GEL, URLA 12/24V alternators test
- Display: 4 alphanumeric lines
- Measurement range: 40 : 2000 CCA (SAE)
- Dimensions: 235x102x68mm
- Special functions: START/STOP batteries, printer, test with engine on 6 languages: EN, FR, D, ES, IT, PT
- Aplicaciones: 12V con baterías de plomo ácido, AGM, EFB, GEL, URLA, 12/24V prueba de alternadores
- Pantalla: 4 líneas alfanuméricas
- Rango de medición: 40 : 2000 CCA (SAE)
- Dimensiones: 235x102x68 mm
- Funciones especiales: baterías START/STOP, impresora, prueba con motor en marcha
- 6 idiomas: EN, FR, D, ES, IT, PT



**TESTER BATTERIE/ALTERNATORI** con stampante  
**DIGITAL BATTERY/CHARGING STARTING SYSTEM TESTER** with printer  
**NEUVO PROBADOR DE BATERÍAS** con impresora

Cod. 04.003.13

€ 82,60

**BT 400**

- Applicazioni: 12V batterie lead acid, AGM, EFB, GEL, URLA 12/24V test alternatori
- Display: 4 linee alfanumerico
- Campo di misura: 40 : 2000 CCA (SAE)
- Dimensioni: 138x96x30mm
- Funzioni speciali: batterie START/STOP (AGM-EFB)
- 10 lingue: EN, FR, D, ES, IT, PT, NL, RU, TK, CZ
- Applications: 12V lead acid batteries, AGM, EFB, GEL, URLA 12/24V alternators test
- Display: 4 alphanumeric lines
- Measurement range: 40 : 2000 CCA (SAE)
- Dimensions: 138x96x30mm
- Special functions: START/STOP batteries (AGM-EFB)
- 10 languages: EN, FR, D, ES, IT, PT, NL, RU, TK, CZ
- Aplicaciones: 12V con baterías de plomo ácido, AGM, EFB, GEL, URLA, 12/24V prueba de alternadores
- Pantalla: 4 líneas alfanuméricas
- Rango de medición: 40 : 2000 CCA (SAE)
- Dimensiones: 138x96x30 mm
- Funciones especiales: baterías START/STOP (AGM-EFB)
- 10 idiomas: EN, FR, D, ES, IT, PT, NL, RU, TK, CZ



**TESTER BATTERIE/ALTERNATORI**  
**DIGITAL BATTERY/CHARGING STARTING SYSTEM TESTER**  
**NEUVO PROBADOR DE BATERÍAS**

N.B.: I modelli BT002, 501, 222 sono ancora disponibili fino ad esaurimento scorte  
The models BT002, 501, 222 remain available until stocks last  
Los modelos BT002, 501, 222 quedan disponibles hasta fin de existencias

# CHARGEMATE 12V 70A

Cod. 03.024.20

€ 495,00

## CARICABATTERIE AUTOMATICO PER BATTERIE 12V AD ACIDO, GEL, AGM, LFP

- Selezione della carica da 3 a 70A
- Funzione **ALIMENTATORE A TAMPONE** (fino a 70 A) con selezione della tensione alla batterie da 12.0 a 15.0V (step 0.1 volt) per riprogrammazione di centraline elettroniche
- Capacità di ricarica batterie: da 30 a 1800Ah
- Protezione contro sovraccarichi
- Protezione contro inversioni di polarità
- Tensione di alimentazione 220/240V 50/60Hz
- Dimensioni: 37x18x13,5cm
- Peso: 8,7kgs (con cavi)

### CORREDO BASE:

Coppia cavi ad occhiello 2,5mt (funzione show room) Cavi batteria staccabili sezione 16mm 2 x 2,5 mt

## AUTOMATIC BATTERY CHARGER FOR 12V ACID, GEL, AGM, LFP BATTERIES

- Charge selection from 3 to 70A
- **BUFFER POWER SUPPLY** function (up to 70A) with selection of the tension supplied to the battery from 12.0 to 15.0V (0.1V step), used to reprogram control units
- Battery charge capacity: from 30 to 1800Ah
- Protection against overcharges
- Protection against polarity inversion
- Supplied tension 220/240V 50/60Hz
- Dimensions: 37x18x13,5cm
- Weight: 8,7kgs (with cables)

### STANDARD OUTFITS:

Pair of 2,5mt cables with eyelet (for showrooms) Detachable battery cables diam. 16mm 2 x 2,5mt

## CARGADOR DE BATERÍAS AUTOMÁTICO PARA BATERÍAS DE ÁCIDO, GEL, AGM, LFP DE 12V

- Selección de carga de 3 a 70A
- Función de fuente de **ALIMENTACIÓN DE BÚFER** (hasta 70A) con selección de la tensión suministrada a la batería de 12.0 a 15.0V (paso de 0.1V), utilizada para reprogramar unidades de control
- Capacidad de carga de la batería: de 30 a 1800Ah
- Protección contra sobrecargas
- Protección contra inversión de polaridad
- Tensión suministrada 220 / 240V 50 / 60Hz
- Dimensiones: 37x18x13,5cm
- Peso: 8,7kgs (con los cables)

### EQUIPAMIENTO ESTANDAR:

Par de cables de 2,5mt con ojal (para showrooms) Cables de batería desmontables diam. 16mm 2x2.5mt



MADE IN ITALY

### Corredo standard / Standard equipment / Equipamiento estandar



### SHOW ROOM SERVICE



PROMO 2022/2

CARICABATTERIE • BATTERY CHARGERS • CARGADORES DE BATERIA

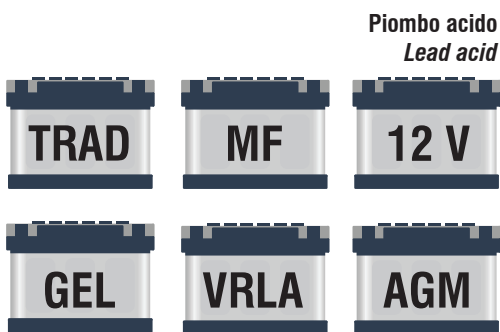

12V WET / VRLA / GEL / MF / AGM (START-STOP)  
LA/CA / LITHIUM LIFEPO4 (SMART LITHIUM)

Piombo acido  
Lead acid

SMART



MADE IN ITALY

“SMART” NUOVA GAMMA  
DI CARICABATTERIE AUTOMATICI

- Aumentano la vita e lo spunto della batteria
- Elevate prestazioni di carica e mantenimento
- Ricaricano di batterie profondamente scariche
- Massima efficienza, minimo consumo energetico
- 100% automatici

CARATTERISTICHE TECNICHE

- > Multi-ciclo con microprocessore
- > Recupero, carica, mantenimento test batterie
- > Idoneo per tutte le batterie al piombo-acido e batterie al litio LiFePO4 (Mod. SMART LITHIUM)
- > Il dispositivo può rimanere sempre collegato alla batteria
- > Cablaggio a tenuta stagna permette un collegamento alla batteria comodo e veloce
- > 100% sicuro: 8 protezioni
- > Alimentazione: 220÷240V, 50÷60Hz
- > Resistente agli agenti atmosferici esterni IP 44
- > 3 anni garanzia

CORREDO STANDARD

- > Cavi di collegamento con connessioni “Superseal”

“SMART” IS THE NEW RANGE OF  
MULTI-CYCLE & AUTOMATIC BATTERY CHARGERS

- Preserve the battery life and power
- High charge performance and maintenance
- Recharge of deep discharged batteries
- Highest efficiency, lowest energy consumption
- 100% automatic

TECHNICAL FEATURES

- > Multi-cycle with microprocessor
- > Recovery, charge, maintenance and battery test
- > Suitable for all types of lead-acid batteries and LiFePO4 batteries (Mod. SMART LITHIUM)
- > The device can stay always connected to the battery
- > The water-proof wiring cable allows a fast and easy connection to the battery
- > 100% safe: 8 different protections
- > IP 44 Weatherproof
- > 3 year warranty

STANDARD OUTFITS

- > External cables with connections “Superseal”



Corredo standard / Standard outfits



- > Cavi di collegamento con connessioni “Superseal”
- > External cables with connections “Superseal”

PROMO 2022/2

ALGORITMO DI CARICA / CHARGING ALGORITHM

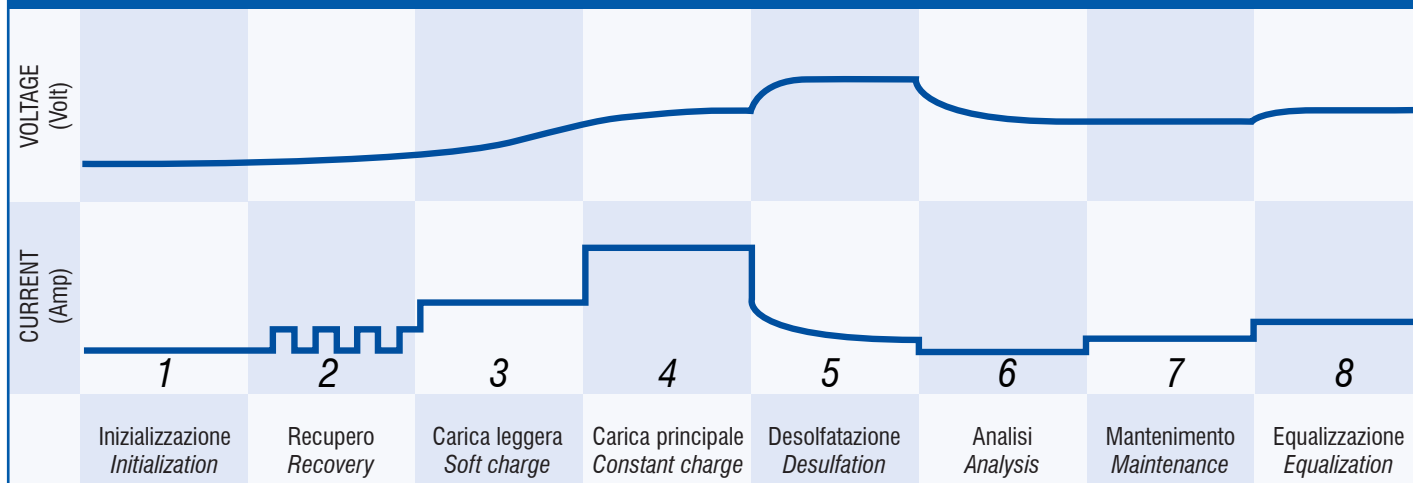

5 ANNI GARANZIA  
WARRANTY 5 YEARS  
GARANTIA 5 AÑOS  
GARANTIE 5 ANS  
5 JAHREN GARANTIE



Modelli disponibili Available models	SMART 200 Cod. 03.024.30	SMART 400 Cod. 03.024.31	SMART 1000 Cod. 03.024.32	SMART LITHIUM Cod. 03.024.33
<b>Volt</b>	6/12V	12V	12V	12V
Capacità batterie <b>Battery capacity</b>	3-100Ah	3-150Ah	3-200Ah	3-100Ah
<b>A max</b>	2	4	10	1,5
Piombo acido <b>Lead-Acid</b> (wet, gel, MF, AGM, VRLA)	✓	✓	✓	✓
Litio <b>Lithium</b> (Life PO4)	—	—	—	✓
Programmi di carica speciali <b>Special charging programs</b>	—	Auto&Moto+AGM <b>Car&amp;Bike+AGM</b>	Auto&Moto+AGM <b>Car&amp;Bike+AGM</b>	—
Modalità alimentazione <b>Power Supply Mode</b>	—	✓	✓	—
Algoritmo di carica – 8 passi <b>Charging algorithm – 8 Steps</b>	✓	✓	✓	✓
PROTEZIONI Corto circuito, inversione di polarità, sovraccarica e surriscaldamento <b>PROTECTIONS</b> <i>Short circuit, polarity inversion, overcharging and overheating</i>	✓	✓ + Compensazione temperatura <b>+ Temperature Compensation</b>	✓ + Compensazione temperatura <b>+ Temperature Compensation</b>	✓ + Polar Mode
Prezzo promo: Promo price:	€ <b>46,00</b>	€ <b>65,90</b>	€ <b>95,60</b>	€ <b>56,90</b>

PROMO 2022/2

CARICABATTERIE • BATTERY CHARGERS • CARGADORES DE BATERIA



# CHARGEMATE 130A 12V

Cod. 03.024.22

€ 1.140,00

CARICABATTERIA A 8 CICLI E ALIMENTATORE PROFESSIONALE 130A 12V

CARATTERISTICHE TECNICHE

- Caricabatterie e alimentatore per ogni tipo di batteria (incluso Start&Stop e Lithium)
- Software specifico per la ricarica batterie Lithium (25% - 50% - 75% - 100%) in accordo con norme per lo stoccaggio
- Solo 10 cm di altezza
- Display alfanumerico 4 righe con indicazione del tipo di batteria (1)
- Ampere di carica (2)
- Volt di carica (3)
- Capacità residua della batteria (4)
- Timer (5)
- Ripristina automaticamente la funzione precedente, in caso di black out
- Alimentatore garantito per 24 ore al 100% della capacità selezionata
- 6 livelli di tensione 12.8 / 13.6 / 13.8 / 14.0 / 14.4 / 14.8V selezionabili

Tensione ingresso Input Voltage	100 ÷ 240V ac, 50-60Hz
Tensione carica Output Voltage	13.8V/14.7V - nom. 12V
Corrente di carica Charging Current	da/from 1A a/to 130A, selezionabile / selectable
Capacità batterie Battery Capacity	10-1300Ah
Tensione alimentatore Power Supply Voltage	da/from 12.8V a/to 14.8V, selezionabile / selectable
Sezione cavi Cable Diameter	25 mm <sup>2</sup>
Lunghezza cavi Cable Length	3 m
Dimensioni Size	37 x 22 x 10 cm
Peso Weight	4.6 Kg

PROFESSIONAL 8 STEPS CHARGER & POWER SUPPLY 130A 12V

TECHNICAL FEATURES

- Charger and power supply for every type of battery (including Start & Stop and Lithium)
- Specific software for recharging Lithium batteries (25% - 50% - 75% - 100%) according to storage standards
- Height 10 cm only
- 4 lines alphanumeric display with battery type indication (1)
- Charged Ampere (2)
- Charged Voltage (3)
- Residual battery capacity (4)
- Timer (5)
- Automatically resets the previous function in case of a blackout
- Guaranteed power supply for 24h at 100% of the selected capacity
- 6 selectable voltage levels: 12.8 / 13.6 / 13.8 / 14.0 / 14.4 / 14.8V

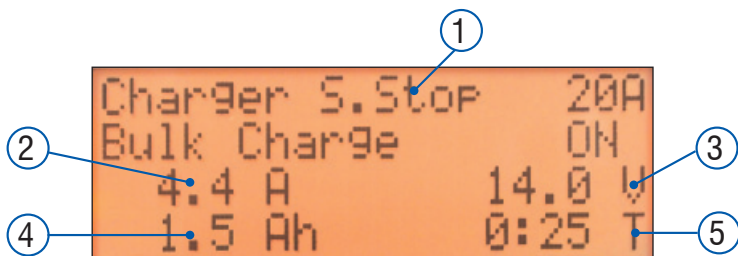

Ultrapiatto, posizionabile sotto le auto in showroom  
Ultra-flat, it can be placed under cars in showroom



CARICABATTERIE INTELLIGENTI • SMART BATTERY CHARGERS

BUDGET

Cod. 03.024.37

€ 78,00

CBA 1000 PRO

NUOVO CARICABATTERIE INTELLIGENTE  
NEW SMART BATTERY CHARGER  
NUEVO CARGADOR DE BATERIA INTELIGENTE



- Corrente di carica: 2A/10A
- Voltaggio della batteria: 6 V / 12 V, Potenza: 160 W
- Tensione CA: 220-240 V CA, 50-60 Hz
- Tipo di ricarica: 10 passaggi, completamente automatico
- Lunghezza cavo: 1,5 M
- Capacità della batteria: 4-200 Ah
- Classe di isolamento: IP65
- Display LCD
- Tipo di batteria: **tutti i tipi di batterie al piombo-acido da 6V/12V e batteria LiFePo4 da 12V**

- Protezione di sicurezza: inversione di polarità/surriscaldamento/cortocircuito/bassa tensione/sovraccarico
- Impostazione della modalità separata ideale per diversi tipi di batteria Ricarica come batteria normale / AGM e GEL e diverse modalità impostano diverse tensioni di spegnimento per rendere la ricarica opzionale
- 6V STD: per la carica della batteria 6V STD
- Alimentazione: conserva memoria/dati quando si sostituisce una batteria e può essere utilizzata come fonte di alimentazione a 12 V per alimentare i tuoi apparecchi a 12 V CC
- **ADATTO PER LA RICARICA DELLA BATTERIA LiFePo4 DA 12V**
- Accessori standard: doppio connettore (2 pinze e occhielli)

- Charging current: 2A / 10A
- Battery voltage: 6V / 12V, Power: 160W
- AC voltage: 220-240VAC, 50-60Hz
- Charging type: 10-Steps, Fully automatic
- Cable length: 1,5 M
- Battery capacity: 4-200 Ah
- Insulation class: IP65
- LCD Display
- **Battery Type: All type of 6V/12V Lead-Acid batteries & 12V LiFePo4 Battery**

- MCU control and LCD display
- Safety Protection: Reverse polarity/Over heat/Short Circuit/Low voltage/Over charge
- Separate Mode setting ideal for different battery types Charging like regular battery / AGM and GEL, and different modes set different off voltages to make optional charging
- 6V STD: For 6V STD battery charge
- Power supply: retain memory/data when replacing a battery & be used as a 12V power source to power up your 12V DC appliances
- **SUITABLE FOR CHARGING 12V LiFePo4 BATTERY CHARGING**
- Standard accessories: double connector (2 pliers and eyelets)

Cod. 03.024.34

€ 34,90

CBA 400 PRO

NUOVO CARICABATTERIE INTELLIGENTE  
NEW SMART BATTERY CHARGER  
NUEVO CARGADOR DE BATERIA INTELIGENTE



- Corrente di carica: 6V: 2A; 12V: Lenta 2A / Veloce 4A
- Voltaggio della batteria: 6V/12V, Max. Potenza: 70W
- Tensione AC: 220VAC-240VAC, 50Hz
- **Tipi di batterie: tutti i tipi di batterie al piombo-acido (WET, MF, Ca/Ca, AGM e GEL)**
- Tipo di caricabatterie: 7 fasi, ciclo di ricarica completamente automatico
- Classe di isolamento: IP65
- Cavo: 1,5mt
- Caratteristiche intelligenti di ricarica a 7 fasi
- Funzione DIAGNOSI e RESCUE
- Diverse funzioni di protezione: inversione di polarità / surriscaldamento / cortocircuito / bassa tensione / sovraccarico
- Morsetti a coccodrillo di alta qualità
- Modalità Freddo: per consentire la carica e mantenere le batterie a basse temperature

- Charging current: 6V: 2A; 12V: Slow 2A / Fast 4A
- Battery voltage : 6V/12V, Max. Power: 70W
- Voltage AC: 220VAC-240VAC, 50Hz
- **Battery Types: All type of lead-acid batteries WET, MF, Ca/Ca, AGM and GEL)**
- Charger type: 7-Step, Fully automatic charging cycle
- Insulation class: IP65
- Cable: 1.5M
- 7-step intelligent charging characteristics
- DIAGNOSIS and RESCUE function
- Various Protection Functions: Reverse polarity / Over heat / Short Circuit / Low voltage / Over charge
- High-quality crocodile clamps
- Cold Mode: to allow charge and maintain batteries at low temperatures

LAMPADA A LED ULTRALUMINOSA

# Lampada sottocofano



ULTRA BRIGHT LED INSPECTION LAMP

## Under Bonnet Lamp

LÁMPARA DE INSPECCIÓN LED ULTRA BRILLANTE

## Lámpara bajo capò

Cod. 05.073.26

€ 94,00

Controllo della modalità di illuminazione  
Lighting mode control  
Control modalidad de iluminación

5W COB LED \*3, 1000Lumens

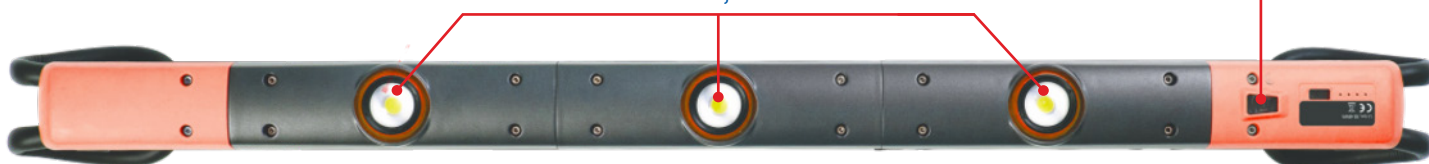

Luminosità  
Light output  
Potencia luminosa



Temperatura di colore  
Colour temperature  
Temperatura del color

3 lampade a led x 5W = 1000 lum

Temperatura di colore: 6000K

Luce bianca intensa

3 livelli di luminosità:

- Alto (3 lampade) - 1000 lum
- Medio (2 lampade) - 675 lum
- Basso (1 lampada) - 350 lum

3x5W LEDs provide 1000 lum light output

6000K colour temperature for bright white light

3 levels of light output:

- High (3 lamps) - 1000 lum
- Med (2 lamps) - 675 lum
- Low (1 lamp) - 350 lum

3 lámparas led x 5W = 1000 lúmenes

Temperatura de color de 6000K para una luz blanca brillante

3 niveles de potencia luminosa:

- Alto (3 lámparas) - 1000 lúm
- Med (2 lámparas) - 675 lúm
- Bajo (1 lámpara) - 350 lúm

Bracci estensibili fino a 1,75 m  
Expandable arms up to 1.75m  
Brazos extensibles hasta 1.7

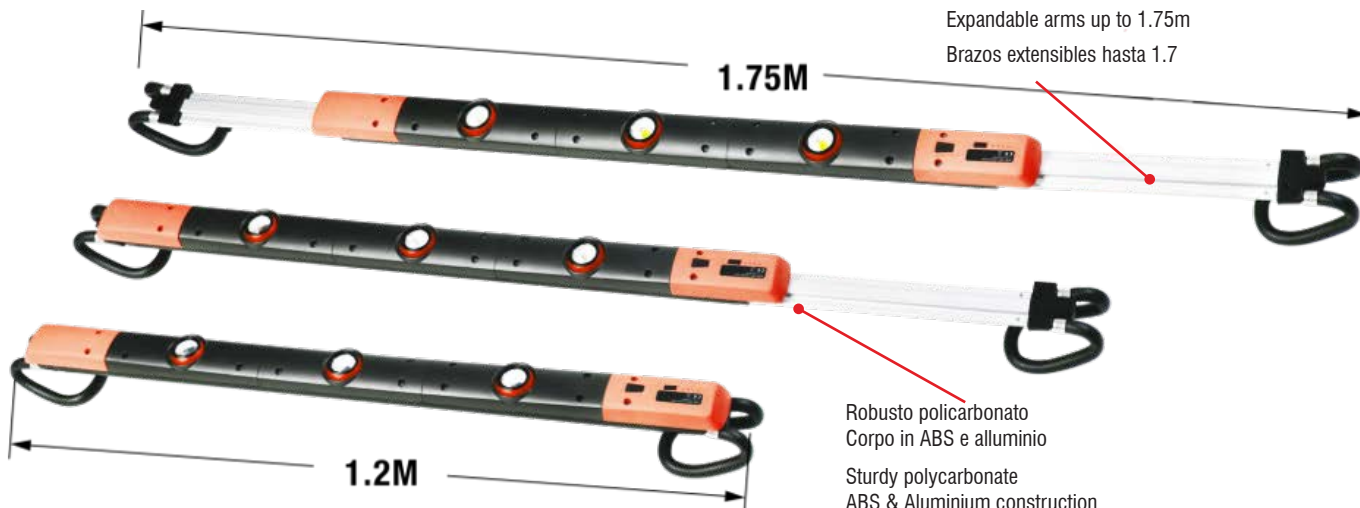

Robusto policarbonato  
Corpo in ABS e alluminio  
Sturdy polycarbonate  
ABS & Aluminium construction  
Policarbonato robusto  
Cuerpo en ABS y aluminio





**Bracci estensibili**  
**Expandable arms**  
**Brazos extensibles**

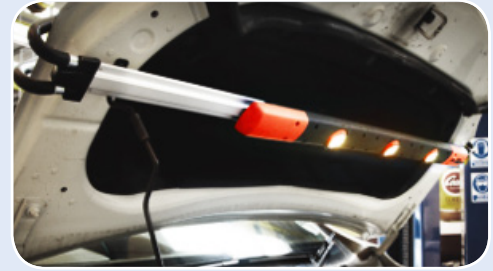

Le testine della luce ruotano indipendentemente per dirigere la luce proprio dove ne hai bisogno

Light heads pivot independently to direct light right where you need it

Los cabezales luminosos pivotan independientemente para dirigir la luz justo donde se necesita

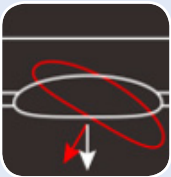
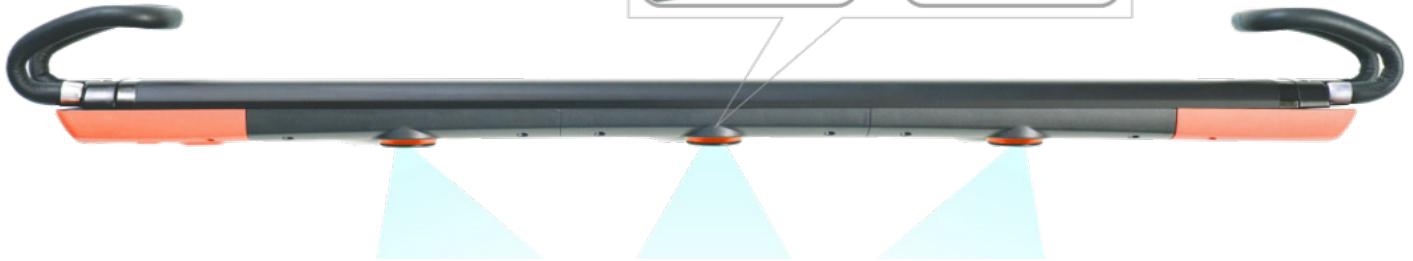
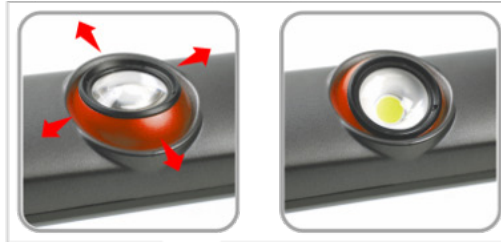

**Multi-angolo**  
**Multi-angle**  
**Multiángulo**



**Fascio luminoso**  
**Beam angle**  
**Ángulo de haz**

Testa regolabile a 40° per illuminare il vano motore esattamente dove serve  
Illuminazione grandangolare a 60°

40° adjustable head to shine light on the engine bay exactly where it is required  
60° wide angle illumination

Cabezal ajustable a 40° para iluminar el vano motor exactamente donde se requiere  
Amplio ángulo de iluminación de 60°



Uscita USB 5V 2000mA  
USB Output 5V 2000mA  
Salida USB 5V 2000mA

Batteria a Li-Ion 3.7V 10400mAh  
3.7V 10400mAh Li-ion Battery  
Batería de iones de litio de 3.7V 10400mAh



**Tempo operativo**  
**Operating time**  
**Tiempo de funcionamiento**



**Tempo di carica**  
**Charging time**  
**Tiempo de carga**

Batteria ricaricabile a Li-Ion 3.7V 10400mAh  
Tempo operativo:  
3 lampade - 6 ore;  
1 lampada - 15 ore  
Tempo di carica: 6,5 ore  
Indicatore luminoso di stato della batteria

Rechargeable 3.7V 10400mAh Li-ion battery  
Operating time:  
3 lamps - 6h;  
1 lamp - 15h  
6,5h recharging time  
Illuminated battery status indicator

Batería recargable de iones de litio de 3.7V 10400mAh  
Tiempo de funcionamiento:  
3 lámparas - 6 h;  
1 lámpara - 15h  
Tiempo de recarga 6,5h  
Indicador de estado de la batería iluminado

Cod. 05.073.51

€ 32,00

**FARETTO 10W CON MANIGLIA MAGNETICA**  
**10W WORK LIGHT WITH MAGNETIC HANDLE**  
**LUZ DE TRABAJO DE 10W CON MANGO MAGNÉTICO**



- Proiettore da **10W** con luce diffusa
- Batteria ricaricabile da 3,7 V 3000 MAh Batteria ricaricabile Li-Ion
- Caricatore USB
- Maniglia magnetica, a 180°
- Dim: 13.6x0,96x0,43 cm
- Dim. imballo: 18.5x13.5x5 cm
- Peso netto/lordo: 0,300/0,370kg
- **10W** handle use design flood light
- 3.7V, 3000 MAH rechargeable Li-Ion battery
- USB charging
- Magnetic handle, 180°
- Dim: 13.6x0,96x0,43 cm
- Pack. dimensions: 18.5x13.5x5 cm
- Net/gross weight: 0,300/0,370kg
- Proyector de **10W** con luz difusa
- Bateria recargable de iones de litio de 3,7 V, 3000 MAH
- Carga USB
- USB, puerto micro
- Mango magnético, 180°
- Dim: 13.6x0,96x0,43 cm
- Dim.de embalaje: 18.5x13.5x5 cm
- Peso neto / bruto: 0,300/0,370kg



Cod. 05.073.25T

€ 42,00

Prezzi netti per quantità  
 Net prices for min. q.ty

**LAMPADA U/V RICARICABILE**  
**RECHARGEABLE U/V LAMP**  
**LAMPARA U/V RECARGABLE**



- Batteria/Battery/Bateria Li-ion/Ion Litio 3,7V 2200mAh
- Isolamento/Insulation/Aislamiento IP65
- Completa di caricabatterie AC e da presa accendisigari / with AC battery charger and cigarette lighter plug / completa con cargador de bateria AC y toma de encendedor de cigarillos: 100/240 V AC
- Occhiali/goggles/gafas
- Funzioni/Functions/Funciones: 100% - 50% - SOS - OFF

Cod. 05.073.24T

€ 22,50

Prezzi netti per quantità  
 Net prices for min. q.ty

**TORCIA U/V A BATTERIA**  
**U/V FLASHLIGHT WITH BATTERIES**  
**LAMPARA U/V DE MANO CON BATERIAS**



- Torcia U/v a batteria
- 1x1,5V batteria inclusa
- Occhiali
- Confezione: cartone
- U/v flashlight with battery
- 1x1,5V battery (included)
- Goggles
- Packaging: cardboard
- Lampara U/v de mano con 1 batteria
- 1x1,5V bateria (incluida)
- Gafas
- Embalaje: carton

Cod. 05.073.25TK

€ 84,00

Prezzi netti per quantità  
 Net prices for min. q.ty



HF01234yf

R134a

Cod. 05.073.24TK

€ 64,50

Prezzi netti per quantità  
 Net prices for min. q.ty



HF01234yf

R134a



Cod. 05.073.28

€ 17,90

**LAMPADA A LUCE SOLARE DA PARETE,**  
con sensore di movimento (da esterno)

**SUNLIGHT LAMP WITH MOTION SENSOR,**  
wall mounted (outdoor)

**LÁMPARA DE LUZ SOLAR CON SENSOR DE MOVIMIENTO,**  
montada en pared (para uso en exteriores)

**DATI TECNICI:**

- Pannello solare da 5,5V/0,6W/ Efficienza 17%
- Batteria al litio 3,7V/1800mAh
- Rileva presenza di persone da 3 a 6mt
- Luminosità: 450 lumen
- Potenza: COB LED 10W
- Grado di isolamento: IP65
- Dimensioni: 153x105x49mm
- Peso: 237gr

**TECHNICAL FEATURES:**

- Solar panel 5.5V / 0.6W / 17% efficiency
- 3.7V / 1800mAh lithium battery
- It detects the presence of people from 3 to 6mt
- Brightness: 450 lumens
- Power: COB LED 10W
- Degree of insulation: IP65
- Dimensions: 153x105x49mm
- Weight: 237gr

**DATOS TÉCNICOS:**

- Panel solar de 5.5V / 0.6W / 17% de eficiencia
- Batería de litio 3.7V / 1800mAh
- Detecta la presencia de personas de 3 a 6 mt
- Luminosidad: 450 lúmenes
- Potencia: COB LED 10W
- Grado de aislamiento: IP65
- Dimensiones: 153x105x49mm
- Peso: 237gr

Cod. 05.073.29

€ 21,00



**LAMPADA FRONTALE**  
con batterie ricaricabili a ioni di litio

**FRONT LAMP**  
with rechargeable lithium ion batteries

**LÁMPARA FRONTAL**  
con baterías recargables de iones de litio

**DATI TECNICI:**

- 5W di potenza lampada frontale
- 3W di potenza luce posteriore
- 4 modalità di regolazione: lampada frontale (100%, 50%, 25%, OFF)
- Autonomia: 100% 2,5-3h; 50% 5-7h; 25% > 10h
- **Cavo USB incluso**

**TECHNICAL FEATURES:**

- 5W of power - front lamp
- 3W of power - rear light
- 4 adjustment modes: front lamp (100%, 50%, 25%, OFF)
- Autonomy: 100% 2.5-3h; 50% 5-7h; 25% > 10h
- **USB cable incl.**

**DATOS TÉCNICOS:**

- 5W de potencia - luz delantera
- 3W de potencia - luz trasera
- 4 modos de ajuste: luz delantera (100%, 50%, 25%, OFF)
- Autonomía: 100% 2.5-3h; 50% 5-7 h; 25% > 10h
- **Cable USB incluido**

**Principali applicazioni**

- Settore "bike"
- Settore trekking e climbing
- Cantieristica in genere
- Protezione civile
- Antinfortunistica

**Principali applicazioni**

- Bike sector
- Trekking and climbing sector
- Building industry in general
- Civil protection
- Accident prevention

**Principali aplicaciones**

- Sector "Bicicleta"
- Sector trekking y escalada
- Industria de construcción en general
- Protección civil
- Prevención de accidentes



Luce con zoom, angolo regolabile  
Twist to zoom, adjustable angle  
Torcer para hacer zoom, ángulo ajustable



Cavo di estensione  
Extension cable  
Cable de extensión



Vano batterie separabile con luce COB  
(rossa/bianca)  
Detachable battery box with COB light (red/white)  
Caja de baterías desmontable con luz COB  
(roja / blanca)



Luce di sicurezza rossa COB  
Red COB safety light  
Luz de seguridad roja COB



Cod. 05.073.30

€ 40,<sup>90</sup>

1000 LUMEN

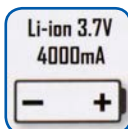

Cod. 05.073.52

€ 28,<sup>60</sup>



LAMPADA LED 5W +1 W COB ricaricabile  
5W +1 W COB rechargeable WORK LAMP  
LAMPARA LED 5W +1 W COB recargable



- Luminosità:  
Corpo 5W COB (ca. 350 Lumen)  
Torchia 1W LED (ca. 180 Lumen)
- Materiale: ABS+PC+TPR
- Batteria: batteria al litio da 3,7V 2000mAh
- Autonomia: ca. 3 ore
- Tempo di ricarica: ca. 3 ore
- Gancio girevole a 360°
- Staffa girevole a 180°
- Spia di carica
- Cavo USB e adattatore 5V 1A
- Funzione di regolazione intensità luce
- Forte magnete sulla staffa e sul retro della lampada

- Brightness:  
Body: 5W COB (circa 350 Lumen)  
Torch: 1W LED (circa 180 Lumen)
- Material: ABS+ PC+ TPR
- Battery: 3.7V 2000mah Li-ion battery
- Working time: about 3 hours
- Charging time: about 3 hours
- 360° rotating hook
- 180° rotating bracket
- Charging indicator light
- USB cable and 5V 1A adapter
- Stepless dimming function
- Strong magnet on the bracket and back of lamp

- Brillo:  
Cuerpo: 5W COB (aprox. 350 lúmenes)  
Linterna: LED de 1 W (aprox. 180 lúmenes)
- Material: ABS + policarbonato + TPR
- Batería: batería de litio de 3,7 V 2000 mAh
- Autonomía: aprox. 3 horas
- Tiempo de carga: aprox. 3 horas
- Gancho giratorio de 360°
- Soporte giratorio de 180°
- Luz de carga
- Cable USB y adaptador 5V 1A
- Función de ajuste de la intensidad de la luz
- Fuerte imán en el soporte y en la parte posterior de la lámpara

Cod. 05.073.40

€ 31,00

Prezzi netti per quantità  
Net prices for min. q.ty

LAMPADA 5W COB CON 2 ASSI GIREVOLI E TORCIA  
2 AXIS ROTATABLE 5W + 1W TORCH COB LAMP

DATI TECNICI:

- LED: 5W COB + 1W SMD
- Batteria: 3.7V 2600mAh 18650 Li
- Luminosità: circa 400LM per il corpo lampada COB, circa 80LM per torcia SMD
- Modalità di commutazione: COB regolabile, interruttore ON / OFF per torcia SMD
- Ore di lavoro: circa 3 ore per lampada COB, circa 12 ore per torcia SMD
- Tempo di ricarica: ca. 4 ore
- Con adattatore CA di 5,5 mm di foro di carica CC, con batteria e indicatore di carica
- Un forte magnete alla base della lampada e due forti magneti nella parte posteriore
- Gancio di traino
- Materiale: ABS + alluminio + PC + gomma
- **Cavo e carica batterie 230V incluso**

TECHNICAL FEATURES:

- LED: 5W COB + 1W SMD
- Battery: 3.7V 2600mAh 18650 Li battery
- Brightness: about 400Lm for body lamp COB, about 80Lm for torch SMD
- Switch mode: adjustable machinery switch for body lamp COB, ON/OFF for torch SMD
- Working time: about 3hours for body lamp COB, about 12hours for torch SMD
- Charing time: about 4hours
- With AC adaptor of 5.5mm DC charging hole, with battery and charging indicator
- 1pc strong magnet at lamp base while 2pcs strong magnets at lamp rear for convenient use
- Retractable hook
- Material: ABS + Aluminum +PC+Rubber
- **230V battery charger and cable included**



Il design RUOTABILE A 2 ASSI consente l'illuminazione a mani libere A PIENO ANGOLO DI ILLUMINAZIONE  
2 AXIS ROTATABLE design allows FULL ANGLE ILLUMINATION



FULL ANGLE ILLUMINATION

LAMPADA INTERCAMBIABILE 2 IN 1  
 INTERCHANGEABLE 2 IN 1 LAMP  
 LÁMPARA INTERCAMBIABLE 2 EN 1

Cod. 05.073.39

€ 34,00

Prezzi netti per quantità  
 Net prices for min. q.ty

5W + 1W COB



**Corpo porta batterie orientabile**  
 Adjustable battery holder body  
 Cuerpo porta batería ajustable

**Lampada COB SLIM**  
 COB SLIM lamp  
 Lámpara COB SLIM

**Torcia elettrica**  
 Electric torch  
 Antorcha eléctrica

**Dati tecnici:**

- LED
- Batteria 3,7V 2200mAh ricaricabile
- **Corpo in alluminio**
- Luminosità:
  - COB: 400lm/200lm
  - Torcia: 50lm
  - Torcia elettrica: 350/180lm
- Caricabatterie: 1A 100/240V

**Technical data:**

- LED
- 3.7V 2200mAh rechargeable battery
- **Aluminum casing**
- Brightness:
  - COB: 400lm/200lm
  - Torch: 50lm
  - Electric torch: 350/180lm
- Battery charger: 1A 100/240V

**Datos técnicos:**

- LED
- Batería recargable de 3.7V 2200mAh
- **Cuerpo de aluminio**
- Brillo:
  - COB: 400lm/200lm
  - Antorcha: 50lm
  - Antorcha eléctrica: 350/180lm
- Cargador batería: 1A 100/240V



Cod. 05.073.47

€ 62,00

### UV LAMP

#### INNOVATIVA LAMPADA DISINFETTANTE A RAGGI UV-C INNOVATIVE UV-C DISINFECTANT LAMP

- Con 18 led, batteria ricaricabile 3,7V 2000mAh
- Idonea per sterilizzare mascherine, cellulari, tastiere, abiti, piani di lavoro, divani, letti, sanitari, gioielli, oggetti per la cura della persona
- **In meno di 1 minuto abbattimento del 99,9% di batteri**
- Spegnimento automatico se rivolto verso il viso o corpo
- Ricarica automatica con cavo mini USB
- 1° carica: 4-5h; autonomia 3H
- 18 LEDs, 3.7V, 2000mAh rechargeable battery
- Suitable for sterilizing masks, cell phones, keyboards, clothes, worktops, sofas, beds, sanitary ware, jewelry, personal care items
- **In less than 1 minute, 99.9% killing of bacteria**
- Automatic shutdown if facing towards the face or body
- Automatic charging with mini USB cable
- First charge: 4-5h; 3h autonomy

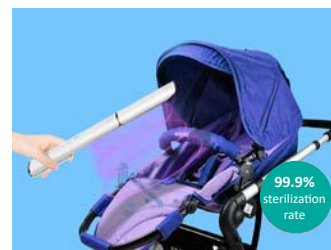

Cod. 05.073.49

€ 38,00

#### FARETTO 10W COB CON MANIGLIA MAGNETICA 10W COB WORK LIGHT WITH MAGNETIC HANDLE LUZ DE TRABAJO DE 10W COB CON MANGO MAGNÉTICO

- Proiettore da 10W con luce diffusa
- Materiale: nylon / TPR
- Batteria ricaricabile da 3,7 V 4400 MAh
- Power bank con indicazione di carica
- Caricatore AC / DC
- USB, micro porta
- Manico a 180 gradi
- Dim: 17.2x12.7x4.2 cm
- Dim. imballo: 20.5x15.5x5.5 cm
- Peso netto/lordo: 0,450/0,535 kg
- 10W handle use design flood light
- Material: Nylon /TPR
- 3.7V 4400 MAh rechargeable battery
- Power bank with charging indication
- AC/DC charger
- USB, micro port
- 180 degree handle
- Dim: 17.2x12.7x4.2 cm
- Pack. dim: 20.5x15.5x5.5 cm
- N/G weight: 0,450/0,535 kg
- Proyector de 10W con luz difusa
- Material: nylon / TPR
- Bateria recargable de 3.7V 4400 MAh
- Power bank con indicación de carga
- Cargador AC/DC
- USB, puerto micro
- Mango de 180 grados
- Dim: 17.2x12.7x4.2 cm
- Dim.de embalaje: 20.5x15.5x5.5 cm
- Peso neto / bruto: 0,450/0,535 kg



Cod. 05.073.38

€ 47,50

SFERA DI LUCE CON MAGNETE  
MAGNETIC LIGHT SPHERE  
LÁMPARA ESFÉRICA IMANTADA

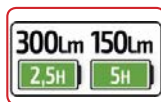
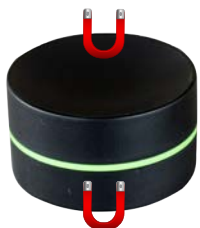

Cod. 05.073.46

€ 12,50

SFERA DI LUCE CON MAGNETE  
MAGNETIC LIGHT SPHERE  
LÁMPARA ESFÉRICA IMANTADA

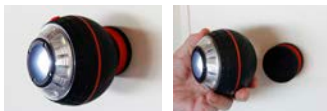

DATI TECNICI:

- Sfera magnetica orientabile a 360°
- 3 posizioni: luce centrale, luce totale, spenta
- Luminosità: 250 lumen
- Alimentazione: 3 x batterie 1,5V AAA (non incluse)

TECHNICAL FEATURES:

- 360° adjustable magnetic sphere
- 3 positions: central light, total light, off
- Brightness: 250 lumen
- Power supply: 3 x 1,5V AAA batteries (not included)

DATOS TÉCNICOS:

- Esfera magnética ajustable 360°
- 3 posiciones: luz central, luz total, apagada
- Brillo: 250 lúmenes
- Fuente de alimentación: 3 pilas de lápiz óptico de 1,5 V AAA (no incluido)



CONVERTITORI AC/DC / AC/DC CONVERTERS / CONVERTIDORES AC/DC



Foto indicativa / Indicative picture



STANDARD PER IHS1500

• COSA SONO

Dispositivi elettronici per produrre corrente alternata alimentandosi da batterie ad acido di auto e camion

• COSA SERVONO

Ad alimentare piccoli elettrodomestici, elettrodomestici, lampade, televisori, apparecchiature elettroniche, computer, forni a microonde, cellulari, pompe elettriche ecc.

• SETTORE DI IMPIEGO

Uso privato, camper, furgoni attrezzati, ambulanti, protezione civile, allestimenti autoambulanze, settore allestimenti nautici

**N.B.:** Se i carichi sono di tipo induttivo, si consiglia di scegliere un convertitore che abbia da 3 a 7 volte la potenza di carico applicata. Es.: un compressore per frigo da 150W richiede circa 1000W all'avviamento

• WHAT ARE THEY

Electronic devices for producing alternating current in cars and trucks by feeding on acid batteries

• WHAT ARE THEY FOR

They are used to power small appliances, electric tools, lamps, televisions, electronic equipment, computers, microwave ovens, cell phones, electric pumps etc.

• APPLICATION SECTOR

Private use, camper, equipped vans, street vendors, civil protection, ambulance equipment, nautical equip.sector

**N.B.:** If the loads are of inductive type, it is advisable to choose a converter that has 3 to 7 times the applied load power. Eg: a 150W fridge compressor requires about 1000W at start-up

• QUÉ SON

Dispositivos electrónicos para producir corriente alterna en automóviles y camiones mediante la alimentación de baterías ácidas.

• PARA QUÉ SON

Se utilizan para alimentar pequeños electrodomésticos, herramientas eléctricas, lámparas, televisores, equipos electrónicos, computadoras, hornos microondas, teléfonos celulares, bombas eléctricas, etc.

• SECTOR DE APLICACIÓN

Uso privado, caravana, furgonetas equipadas, vendedores ambulantes, protección civil, equipo de ambulancia, sector de equipos náuticos

**N.B.:** Si las cargas son de tipo inductivo, es aconsejable elegir un convertidor que tenga de 3 a 7 veces la potencia de carga aplicada. Por ejemplo: un compresor de refrigerador de 150 W requiere aproximadamente 1000W durante el arranque

CARATTERISTICHE TECNICHE TECHNICAL FEATURES CARACTERÍSTICA TÉCNICAS	MODELLI	
	IHS200 Cod. 03.050.00	IHS1500 Cod. 03.050.06
Potenza resa continua Continuous power Potencia rendimiento continuo	200W 12V DC	1500W 12V DC
Potenza di picco / Peak power / Potencia de pico	500W	3000W
Forma d'onda / Wave form / Forma de onda	Sinusoidal modificata Modified sinusoidal Sinusoidal modificada	Onda pura Pure wave
Efficienza / Efficiency / Eficiencia	>85%	>85%
Assorbimento senza carico Absorption without charge Absorción sin cargo	0,3A	
Protezione conto corto circuito Protection against short circuit Protección contra cortocircuito	Si / Yes	Si / Yes
Avvio graduale / Soft start / Arranque suave	Si / Yes	Si / Yes
Protezione sovratensione 15V DC Protection against over tension 15V DC Protección contra sobretensión 15V DC	Si / Yes	Si / Yes
Raffreddamento a ventola / Fan cooling / Ventilador de enfriamiento	No	Si / Yes
Spia allarme basso voltaggio 10V DC Alarm light for low voltage 10V DC Luz de alarma para baja tensión 10V DC	10,5V ± 0,5	10,5V ± 0,5
Interruzione alimentazione di batteria Battery power failure Interrupción de potencia en la batería	Si / Yes	Si / Yes
Protezione contro inversione di polarità Protection against reverse polarity Protección contra polaridad inversa	Si / Yes	Si / Yes
Tensione in uscita /Output tension / Tension en salida	220 AC ± 5%	220 AC ± 5%
Dimensioni mm / Peso kgs Dimensions mm / Weight kgs Dimensiones mm / Peso kgs	192x95,6x6,53 mm 0,834 kgs	420x223x103 mm 6,2 kgs
Prezzo promo Promo price Precio promo	€ 36,00	€ 420,00

ACCESSORI AUTO-VAN-CAMPER-CAMION  
ACCESSORIES FOR CARS – VANS – CAMPER VANS - TRUCKS  
ACCESORIOS PARA COCHES - FURGONETAS - CARAVANAS – CAMIONES

Cod. 05.090.10 € 98,00

**MOLTIPLICATORE DI COPPIA**  
per smontaggio bulloni di camion e furgoni

**MULTIPLIER-COUPLE FOR**  
the disassembly of the truck and van bolts

**MULTIPLICADOR DE PAR** para desmontaje bulones  
de camiones y furgonetas

- Coppia max / Max torque / Par máx: 3800 Nm
- Rapporto riduzione /gear ratio / Relación de transmisión: 1:56
- Include 7 bussole / Incl.7 sockets / 7 casquillos: 24 - 38 mm





Cod. 05.090.13 € 49,00

- Coppia max / Max torque / Par máx: 3800 Nm
- Rapporto riduzione /gear ratio / Relación de transmisión: 1:56
- Include 2 bussole / Incl. 2 sockets / 2 casquillos: 32 - 33 mm



CAVI DI SOCCORSO • JUMPER CABLES • CABLES DE SOCORRO

<b>Cod. 05.060.02</b> € <b>18,50</b>	<b>Cod. 05.060.03</b> € <b>26,00</b>	<b>Cod. 05.060.04J</b> € <b>104,00</b>
PER USO PRIVATO PRIVATE USE	PER USO PROFESSIONALE FOR PROFESSIONAL USE	PER USO PROFESSIONALE FOR PROFESSIONAL USE
		
PLACCATO IN RAME COPPER PLATED	PLACCATO IN RAME COPPER PLATED	RAME PURO 100% PURE 100% COPPER
Ampere: <b>350 A</b>	Ampere: <b>480 A</b>	Ampere: <b>1000 A</b>
Sezione/Section: <b>25 mm<sup>2</sup></b>	Sezione/Section: <b>35 mm<sup>2</sup></b>	Sezione/Section: <b>70 mm<sup>2</sup></b>
<b>L=3,5 mt</b>	<b>L=4,5 mt</b>	<b>L=5 mt</b>
Usò/application: Auto - Camper - veicoli commerciali Cars - campers - commercial vehicles Coches - caravanas - vehículos comerciales	Usò/application: Auto - Camper - veicoli commerciali - autocarri Cars - campers - commercial vehicles - trucks Coches - caravanas - vehículos com. - camiones	Usò/application: Movimento terra - autocarri - bus Earth-moving machines - trucks - buses Máquinas para movimiento de tierra - camiones - autobús
Norme/norms/normas: TÜV GS CE	Norme/norms/normas: TÜV GS CE	Norme/norms/normas: CE

**Cod. 05.013.04**

€ **28,00**

PROTEZIONE FRONTALE / LATERALE PER AUTO  
FRONT / SIDE PROTECTION FOR CARS  
PROTECCIÓN DELANTERA / LATERAL PARA COCHES

- Materiale: nylon impermeabile
- Dimensioni: 380x70 cm

- Material: Waterproof nylon
- Dimensions: 380x70 cm

- Material: nailon impermeable
- Dimensiones: 380x70 cm



Cod. 04.014.01

€ 99,00

**TERMOMETRO DIGITALE A RAGGI INFRAROSSI**

con puntatore laser (-30/+1150°C)

**DIGITAL INFRARED THERMOMETER**

with laser pointer (-30/+1150°C)

**TERMÓMETRO DIGITAL DE RAYOS INFRARROJOS**

con puntador laser (-30/+1150°C)



**APPLICAZIONI:**

**Automotive:** collettori di scarico; marmitte catalitiche; radiatori; motori marini.

**Industriali:** forni; compressori; motori diesel; impianti industriali in genere; cabine di verniciatura ecc.

- Misura della temperatura senza contatto
- Spegnimento automatico
- Grado di emissività regolabile da 0,10 a 1
- Rapporto distanza-dimensioni: 20:1
- Data hold

**USE:**

**Automotive:** discharge manifolds; catalytic silencers; radiators; marine motors.

**Industrial:** furnaces; compressors; diesel engines; general industrial plants; spray booths; ecc.

- Non-contact temperature measurement
- Auto Power Off
- Adjustable emissivity: from 0,10 to 1
- Distance spot ratio: 20:1
- Data hold

**USOS:**

**Automoción:** colectores de descarga; catalizadores; radiadores; motores marinos

**Industriales:** hornos, compresores; motores diesel; instalaciones industriales, cabinas de pintura; ecc.

- Medición de la temperatura sin contacto
- Apagado automático
- Grado de emisión regulable de 0,10 a 1
- Relación distancia-dimensiones: 20:1
- Data hold

Cod. 04.013.05

€ 38,40

**TERMOMETRO DIGITALE A RAGGI INFRAROSSI**

con puntatore laser (-50°/+400°)

**DIGITAL INFRARED THERMOMETER**

with laser pointer (-50°/+400°)

**TERMÓMETRO DIGITAL DE RAYOS INFRARROJOS**

con puntador laser (-50°/+400°)



- Misura della temperatura senza contatto
- Spegnimento automatico
- Grado di emissività regolabile 0,95 (fisso)
- Rapporto distanza-dimensioni: 12:1
- Data hold

- Non-contact temperature measurement
- Auto Power Off
- Adjustable emissivity: from 0,95 (fixed)
- Distance spot ratio: 12:1
- Data hold

- Medición de la temperatura sin contacto
- Apagado automático
- Grado de emisión regulable 0,95 (fijo)
- Relación distancia-dimensiones: 12:1
- Data hold

Cod. 04.052.00

€ 8,50

**TERMOMETRO DIGITALE A PENNA -50°/+150°C**

**DIGITAL PEN THERMOMETER -50°/+150°C**

**TERMÓMETRO TIPO BOLÍGRAFO DIGITAL -50°/+150°C**



**CK-EXPORT**  
U/S WASHING TANKS

VASCHE AD ULTRASUONI SERIE CK-EXPORT  
ULTRASONIC WASHING TANKS CK-EXPORT SERIES  
BAÑOS DE ULTRASONIDOS SERIE CK-EXPORT



Foto indicativa / Indicative picture

**I CAMPI DI UTILIZZO:**

- Laboratori di meccanica di precisione (lavaggio minuterie)
- Laboratori di elettronica per lavaggio circuiti stampati
- Autofficine e specialisti iniezione benzina e diesel per pulitura carburatori, elettroiniettori, piccola minuteria meccanica, indotti, statori ecc.
- Carrozzerie per pulizie pistole di verniciatura

**FIELDS OF APPLICATION:**

- Precision mechanics workshops
- Electronic laboratories for washing printed circuits
- Car repair shops and specialist shops for fuel and diesel injection parts and for cleaning carburetors, electric injectors, small mechanic parts, armatures, stators, etc.
- Workshops for painting guns cleaning

Modelli disponibili Available models	CK 2 02.009.15	CK 3 02.009.13	CK 6 02.009.16	CK 9 02.009.17	CK 13 02.009.24	CK 27 02.009.25
Dim. vasca / Tank size (cm)	15x14x10	24x14x10	30x15,5x15	30x24x15	33x30x15	50x30x20
Dim. esterne / External size (cm)	18x17x24	27x17x24	33x17x31	33x27x31	36x33x31	53x33x36
Capacità / Tank capacity (lt.)	2	3	6	9,5	13	27
Potenza ultrasuoni / U/S power	60W	120W	180W	240W	360W	600W
Frequenza / frequency (KHz)	40	40	40	40	40	40
Alimentazione / Power Supply	220 V 50/60 Hz	220 V 50/60 Hz	220 V 50/60 Hz	220 V 50/60 Hz	220 V 50/60 Hz	220 V 50/60 Hz
Potenza riscaldamento (W) Heating power (W)	100W	100W	300W	300W	400W	500W
Cestello / Basket	✓	✓	✓	✓	✓	✓
Rubinetto di scarico Discharge valve	-	-	-	✓	✓	✓
Tanica liquido 5411, 1 lt 1lt tank of 5411 liquid	✓	✓	✓	✓	✓	✓
Prezzo Promo / Promo Price	€ 109, <sup>50</sup>	€ 139, <sup>00</sup>	€ 233, <sup>00</sup>	€ 283, <sup>00</sup>	€ 445, <sup>00</sup>	€ 639, <sup>00</sup>

Cod. 02.000.101 € 11,<sup>00</sup>



Tanica liquido 5411 per le vasche u/s CK EXPORT, 1 lt  
Max diluizione al 10% (90% acqua)

1lt tank of 5411 liquid for CK EXPORT u/s washing tanks  
Max 10% dilution (90% water)

Cod. 02.000.43 € 42,<sup>00</sup>



Tanica liquido 5411 per le vasche u/s CK EXPORT, 5 lt  
Max diluizione al 10% (90% acqua)

5lt tank of 5411 liquid for CK EXPORT u/s washing tanks  
Max 10% dilution (90% water)

VASCHE ULTRASUONI SERIE CK-EXPORT  
ULTRASONIC WASHERS CK-EXPORT SERIES  
BAÑOS DE ULTRASONIDOS SERIE CK-EXPORT

**CK-EXPORT**  
INDUSTRIAL U/S WASHING TANKS



Foto indicativa / Indicative picture

**I CAMPI DI UTILIZZO:**

- Applicazioni settore auto: lavaggio testate motori, cerchi in lega, particolari metallici di medie dimensioni.
- Utilizzare solo detersivi a base acquosa a temperatura  $\geq 70^\circ$
- Cestello di lavaggio incluso
- Modelli su misura a richiesta

**FIELDS OF APPLICATION:**

- Automotive Applications: cleaning of motor parts, alloy wheels, metal parts.
- Use water based detergents only, at a temperature of  $\geq 70^\circ$
- Basket included
- Special size models on request



Modelli disponibili Available models	CK 800 (T-18S) 02.009.22	CK 2000 (T-36S) 02.009.23	CK 2400 (T-60S) 02.009.18	CK 3600 (T-72S) 02.009.19
Dim. vasca / Tank size (cm)	50x35x30	60x50x45	80x60x55	100x60x60
Dim.esterne / External size (cm)	57x45x65	67x60x78	92x72x88	115x72x95
Capacità / Tank capacity (lt.)	53 L	135 L	264 L	360 L
Potenza u/s / U/s power (W)	0,9 Kw	1,8 Kw	3 Kw	3,6 Kw
Frequenza / Frequency (KHz)	28	28	28	28
Alimentazione / Power Supply	220 V one phase	400 V 50Hz 3 phases	400 V 50Hz 3 phases	400 V 50Hz 3 phases
Potenza riscaldamento (W) Heating power (W)	1,5 Kw	4,5 Kw	6 Kw	9 Kw
Cestello incluso / Basket incl.	✓	✓	✓	✓
Rubinetto di scarico incluso Discharge valve included	✓	✓	✓	✓
Coperchio in acciaio inox Inox steel cover	✓	✓	✓	✓
Peso / Weight / Peso (kg)	80 kg	120 kg	205 kg	260 kg
<b>Prezzo Promo / Promo Price</b>	<b>€ 1.750,00</b>	<b>€ 3.800,00</b>	<b>€ 4.800,00</b>	<b>€ 5.500,00</b>

PROMO 2022/2



**Cod. 03.036.17 € 165,00**

> Vasca lavaggio da 75lt (incluso pennello)

- Con pompa elettrica 230V 50Hz
- Dimensioni imballo: 790x550x320mm
- Peso: 28 kg

> 75lts Cleaning tank (brush included)

- With electric pump 230V 50Hz
- Packaging dimensions: 790x550x320mm
- Weight 28 kgs

**Cod. 02.000.96 € 99,00**

> Liquido per vasca 03.036.17, 25lt

(diluizione al 50% in acqua)

> 25lt liquid

for the cleaning tank art. 03.036.17

dilution 50% in water



← CONSIGLIATO ACQUISTO COMBINATO SUGGESTED COMBINED PURCHASE →

**ATTREZZATURE PER LA REFRIGERAZIONE/CONDIZIONAMENTO**  
**REFRIGERATION/AIR CONDITIONING EQUIPMENT**  
**EQUIPO DE REFRIGERACIÓN Y AIRE ACONDICIONADO**

**KIT CERCAFUGHE AZOTO / IDROGENO (H2N2)**  
**NITROGEN / HYDROGEN (H2N2) LEAK DETECTION KIT**  
**KIT DE DETECCIÓN DE FUGAS DE NITRÓGENO / HIDRÓGENO (H2N2)**

Cod. 01.000.310 € **550,00**



**KIT CARRELLO PORTA BOMBOLE per servizio aria condizionata**  
**TROLLEY KIT FOR CYLINDERS for A/C service**  
**KIT CARRO PORTABOMBONAS para el mantenimiento A/A**

**IL KIT INCLUDE:**

- Carrello porta bombole con ruote piene Ø 260mm (bombole esclusa)
- Tasca porta strumentazione
- Cercafughe N2H2 (01.000.203M) ①
- Manometro doppio indice ③
- Coppia attacchi LP 134/1234 ⑥ ⑦
- Tubo L=1,5 mt ¼ sae m/m ⑤
- Riduttore di pressione inlet 0-300 bar / outlet 0-60 bar ④
- Può portare una bombole (venduta separatamente) da max 10 lt/220bar

**THE KIT INCLUDES:**

- Cylinder trolley with inflatable wheels Ø 260mm (bottle esclusa)
- Instrument pocket
- N2H2 leak detector (01.000.203M) ①
- Double scale manometer ③
- 2 quick LP couplers 134/1234 ⑥ ⑦
- Hose L=1,5 mt ¼ sae m/m ⑤
- Pressure reducer: Inlet 0-300 bar / outlet 0-60 bar ④
- It can carry a cylinder (sold separately) of max 10lt/220bar

**EL KIT INCLUYE:**

- Carro portabombonas con ruedas llenas Ø 260mm (bombole no incluida)
- Compartimento portaherramientas
- Detector de fugas de N2H2 (01.000.203M) ①
- Manómetro de doble índice ③
- Pareja de acoplamiento BP 134/1234 ⑥ ⑦
- Manguera L = 1,5 mt ¼ sae m/m ⑤
- Reductor de presión de entrada 0-300 bar / salida 0-60 bar ④
- Puede llevar una bombole (vendida por separado) de un máximo de 10lt/220bar

01.000.203M	01.090.07	01.090.08.R3	01.090.08.R4	01.000.317
①	②	③	④	⑤
Cercafughe per idrogeno Hydrogen leak detector Detector de fugas de hidrógeno	Bombole azoto/idrogeno 1lt Nitrogen/hydrogen cylinder 1 lt Cilindro de nitrógeno/hidrógeno 1lt	Manometro con tubo e rubinetto Manifold gauge with hose & tap Manómetro con tubo R134a, R1234yf, R404a, R407C, R422D, R507, R22, R32, R410a	Regolatore di pressione Pressure regulator Regulador de presión	Tubo giallo 1,5 m Fx F ¼ SAE 180° Yellow hose 1,5 m Fx F ¼ SAE 180° Manguera amarilla 1,5 m Fx F ¼ SAE 180°
01.000.312	01.000.314	01.090.08.R1	01.000.318	01.000.311.R1
⑥	⑦	⑧	⑨	⑩
Attacco rapido LP ¼ SAE con rubinetto per R134a LP quick coupler ¼ SAE with tap for R134a Acoplamiento rápido LP ¼ SAE con grifo para R134a	Attacco rapido LP ¼ SAE con rubinetto per R1234yf LP quick coupler ¼ SAE with tap for R1234yf Acoplamiento rápido LP ¼ SAE con grifo para R1234yf	Riduttore bombole 1 lt 1 lt cylinder reduction 1 lt cilindro reductor	Adattatore M1/4 SAE per M1234yf - M12x1,5 Adapter M1/4 SAE x M1234yf - M12x1,5 Adaptador M1/4 SAE para M1234yf - M12x1,5	Regolatore di pressione fino 20 bar per bombole non ricaricabili Pressure regulator up to 20 bar for non-refillable cylinders Regulador de presión hasta 20 bar para cilindros no rellenables

PROMO 2022/2

Cod. 01.000.225

€ 427,00

ADVANCE KIT



**KIT CERCAFUGHE PER IMPIANTI A/C R134A/R1234YF** e refrigerazione con miscela N2-H2 (95%/5%) e cercafughe elettronico

**LEAK DETECTION KIT FOR A/C R134A AND R1234YF SYSTEMS** and refrigeration systems with a N2-H2 mix (95%/5%) and electronic leak detector

**KIT DETECTOR DE FUGAS PARA SISTEMAS DE A/A R134/HFO1234YF** y sistemas de refrigeración con una mezcla de N2-H2 (95%-5%) y detector de fugas electrónico

IL KIT INCLUDE:

1. Cercafughe per H2 (2gr/annuo)
2. Bombola da 950cc N2-H2
3. Manometro doppia scala
4. Regolatore di pressione (300 bar)
5. Tubo di collegamento
6. Raccordo BP R134a
7. Raccordo BP R1234yf
8. Riduttore per bombola

THE KIT INCLUDES:

1. Leak detector for H2 (2gr/yearly)
2. 950cc N2-H2 cylinder
3. Double scale gauge
4. Pressure regulator (300 bar)
5. Connecting hose
6. LP coupling R134a
7. LP coupling R1234yf
8. Reducer for cylinder

EL KIT INCLUYE:

1. Detector de fugas H2 (2gr / año)
2. Cilindro 950cc N2-H2
3. Manómetro de doble escala
4. Regulador de presión (300 bar)
5. Tubo de conexión
6. Acoplam. LP R134a
7. Acoplam. LP R1234yf
8. Reductor para cilindro

Cod. 01.090.08

€ 246,00



**Kit pressurizzazione impianti con bombola azoto-idrogeno N2-H2**

Come cod. 01.000.225, ma senza il cercafughe per idrogeno H2

**Pressurization systems kit with nitrogen-hydrogen N2-H2**

Same as cod. 01.000.225, but without the leak detector for hydrogen H2

**Kit para pressurización de sistemas con nitrógeno-hidrógeno N2-H2**

Lo mismo que el cod. 01.000.225, pero sin el detector de fugas para H2

Cod. 01.000.311

€ 172,00

BASIC KIT



**KIT CERCAFUGHE PER IMPIANTI A/C R134A/R1234YF**

solo per bombole non ricaricabili (150ml, 2200 ml - 110 bar)

**LEAK DETECTION KIT FOR A/C R134A AND R1234YF SYSTEMS**

only for non-refillable cylinders (150 ml, 2200 ml - 110 bar)

**KIT DETECTOR DE FUGAS PARA SISTEMAS DE A/A R134/HFO1234YF**

solo para cilindros no recargables (150 ml, 2200 ml - 110 bar)

IL KIT INCLUDE\*:

- Bombola N2H2 950 ml, non ricaricabile (2)
- Manometro doppia scala con tubo e rubinetto (3)
- Tubo, 80cm, ¼ SAE FF (5)
- Coppia attacchi rapidi ¼ SAE R134a (LP) - R1234yf (LP) (6) (7)
- Riduttore per bombola (8)
- Riduttore di pressione fino a 20 bar per bombole da 1 lt (10)

THE KIT INCLUDES\*:

- N2H2 950 ml cylinder, not refillable (2)
- Double scale pressure gauge with hose and tap (3)
- Tube, 80cm, ¼ SAE FF (5)
- Quick couplings ¼ SAE R134a (LP) - R1234yf (LP) (6) (7)
- Cylinder reduction (8)
- Pressure reducer up to 20 bar for 1 lt cylinders (10)

EL KIT INCLUYE\*:

- Cilindro N2H2 de 950 ml, no recargable (2)
- Manómetro de doble escala con manguera y grifo (3)
- Tubo, 80 cm, ¼ SAE FF (5)
- Acoplamientos rápidos ¼ SAE R134a (LP) - R1234yf (LP) (6) (7)
- Reductor para cilindro (8)
- Reductor de presión hasta 20 bar para cilindros de 1 litro (10)



Cod. 01.000.203M

€ 181,00

Cercafughe Elettronico **N2-H2 MULTI REFRIGERANTE** (CFC, HCFC, HFO1234YF, R134A, N2-H2)  
**MULTI REFRIGERANT N2-H2** Electronic Leak Detector (CFC, HCFC, HFO1234YF, R134A, N2-H2)  
 Detector de fugas electronico **N2-H2 MULTI-REFRIGERANTE** (CFC, HCFC, HFO1234YF, R134A, N2-H2)

Cod. 01.000.203.R1

€ 70,00

**Sensore** per cercafughe Multirefrigerante (Ricambio for Cod. 01.000.203M)  
 Multi Refrigerant Leak Detector **sensor** (Spare part for Cod. 01.000.203M)  
**Sensor** para detector de fugas electronico Multirefrigerante (Pieza de repuesto para Cod. 01.000.203M)

Cod. 01.090.07

€ 26,00

**Bombola con miscela azoto-idrogeno N2-H2** (95%/5%), 950cc. Non ricaricabile.  
**Nitrogen-Hydrogen N2-H2 Cylinder** (95%/5%), 950cc. Not rechargeable.



Cod. 01.090.13

€ 47,00

**Bombola da 2 lt con miscela azoto-idrogeno N2-H2** (95%/5%), 110 bar. Non ricaricabile.  
**2 lt Nitrogen-Hydrogen N2-H2 Cylinder** (95%/5%), 110 bars. Not rechargeable.

Cod. 01.090.15

€ 238,00

**Bombola ricaricabile da 5 lt**  
 di azoto-idrogeno N2-H2 (95%/5%), 200bar  
**5 lt Refillable Nitrogen-Hydrogen N2-H2 Cylinder**  
 (95%/5%), 200 bars

Cod. 01.090.16

€ 360,00

**Bombola ricaricabile da 10 lt**  
 di azoto-idrogeno N2-H2 (95%/5%), 200bar  
**10 lt Refillable Nitrogen-Hydrogen N2-H2 Cylinder**  
 (95%/5%), 200 bars



Cod. 01.000.100

€ 78,60



**Cercafughe elettronico a LED**,  
 per refrigeranti R134a, R22,  
 R404

**LED electronic leak detector**  
 for R134a, R22, R404  
 refrigerant

**Detector electrónico de fugas**

**LED** para refrigerantes R134a,  
 R22, R404

**R134a**

Coppia attacchi rapidi per **R134a**, con rubinetto  
 Special rapid couplings for **R134a**, with taps

Cod. 01.000.08

€ 54,00

Made in EU

Cod. 01.000.08IMP

€ 28,70

Imported

**R134a**



**R1234yf**

Coppia attacchi rapidi per **R1234yf**, con rubinetto  
 Special rapid couplings for **R1234yf**, with taps

Cod. 01.000.168

€ 65,00

Made in EU

Cod. 01.000.168IMP

€ 34,30

Imported

**HF01234yf**



Cod. 05.090.73

€ 16,10



**KIT SMONTAGGIO VALVOLE IMPIANTI A/C CON INSERTI PENTALOBATI**  
**KIT FOR DISASSEMBLING VALVES ON A/C SYSTEMS WITH FIVE-POINT BITS**

Utile per lo smontaggio dei tappi in plastica e della  
 valvola interna su impianti di aria condizionata.

**IL KIT INCLUDE:**

- 2 bussole femmina ottagonali
- 2 chiavi a forchetta 2,2mm/3,2mm
- 1 porta inserti 1/4"
- Kit di 7 inserti pentalobati (TS10, TS15, TS20, TS25, TS27, TS30, TS40)

Useful for the disassembly of the plastic caps and the  
 internal valve of air conditioning installations.

**IL KIT INCLUDE:**

- 2 socket female octagonal wrenches
- 2 open-ended spanners 2.2mm/3.2mm
- 1 bit holder 1/4 "
- Kit of 7 five-lobed inserts (TS10, TS15, TS20, TS25, TS27, TS30, TS40)



Cod. 01.090.04 € 63,00



**Gruppo manometrico a 4 vie con 3 tubi**  
L=150mm e valigetta di trasporto  
(scale R22-R134a-R407c-R410a)

Four-way **manometric group** with 3 hoses  
L=150mm and transport case  
(for R22-R134a-R407c-R410a)

**Grupo manométrico de 4 vías con 3 mangueras**  
L = 150mm (rojo, azul, amarillo) y caja de  
transporte (para gas R22-R134-R407c-R410a)

Cod. 01.090.00 € 63,00

Per/for/para R22-R134a-R404c-R407a)

Cod. 01.090.12 € 95,00

**Gruppo manometrico a 4 vie per HF01234yf**  
**Four-way manometric group for HF01234yf**  
**Grupo manométrico de 4 vías para HF01234yf**

Cod. 01.000.214 € 182,00



**Bilancia elettronica,**  
alimentazione batteria 9V.  
Portata: 100Kg

**Electronic scale,** 9V battery  
power supply. Capacity:100Kg

**Balanza electrónica,**  
con alimentacion bateria 9V.  
Capacidad: 100Kg

Cod. 01.000.319 € 10,80



Adattatori per lavaggio tubi interni e esterni per stazioni clima R134a  
Adapters for washing of internal and external hoses for R134a A/C stations

Cod. 01.000.320 € 12,80



Adattatori per lavaggio tubi interni e esterni per stazioni clima R1234yf  
Adapters for washing of internal and external hoses for R1234yf A/C stations

Cod.01.090.10 € 76,00



**Kit Flangiatubi**  
**Flaring Tool Set**  
**Juego de brida de la tubería**

Flangiatubi / Flaring / Ensanchador: Ø 6, 8,  
10, 12, 16, 19 mm,

Misura tubi / ube size / Diametro del tubo:  
1/4", 5/16", 3/8", 5/8", 3/4"

Tagliatubi / Tube cutter / Cortador de tubos:  
1/8" ÷ 1.1/8" (4-28mm)

Cod. 01.090.11 € 18,00



Tagliatubi: 1/8" ÷ 1.1/4" (4-32mm)

Tube Cutter: 1/8" ÷ 1.1/4" (4-32mm)

Cortador de tubos: 1/8" ÷ 1.1/4" (4-32mm)

Cod. 01.090.01 € 325,00



**Pompa a vuoto bistadio 220V, 50Hz con maniglia,**  
vacuometro e elettrovalvola, portata **170 lt/min,**  
raccordi 1/4 SAE-3/8 SAE

**Dual stage vacuum pump 220V 50Hz with handle,**  
vacuometer and electro-valve, capacity: **170 lt/min,**  
1/4 SAE-3/8 SAE couplings

**Bomba de vacío de doble etapa 220V 50Hz con**  
mango, vacuómetro y electroválvula, capacidad:  
170lt/1', acoplamientos SAE 1/4 SAE-3/8

Cod. 01.017.05 € 939,00



Motore brushless DC ¾ HP, indicatore di  
pressione digitale, monopistone, **compressore**  
**oil-less, raffreddato ad aria, separatore olio,**  
**motore antiscintilla.**

Dimensioni 450x250x365, peso 14,7Kg

Brushless DC motor ¾ HP, digital pressure gauge,  
single piston. **aircooled, oil-less compressor, oil**  
**separator, anti-spark engine**

Dimensions: 304x202x260mm, weight: 7,8kg

Cod. 01.017.06 € 805,00



Motore brushless DC ¾ HP, indicatore  
di pressione digitale, monopistone,  
funzione spurgo automatico. Dimensioni  
304x202x260mm, peso 7,8kg

Brushless DC motor ¾ HP, digital pressure  
gauge, single piston, automatic purge function  
Dimensions: 304x202x260mm,  
weight: 7,8kg

Cod. WCR000103 € 42,60



**KIT MANUTENZIONE ANNUALE STAZIONI A/C SPIN**  
**(ESCL. ASTRABUS)**

**ANNUAL MAINTENANCE KIT FOR SPIN A/C STATIONS**  
**(EXCL. ASTRABUS)**

**IL KIT INCLUDE:**

- 0,5 lt olio per pompa a vuoto
- 1 filtro deidratatore 1/4 SAE
- 10 guarnizioni per tubi refrigerante

**THE KIT INCLUDES:**

- vacuum pump oil, 0,5 lt
- 1/4 SAE dehydrator filter
- 10 gaskets for refrigerant hoses



Cod. 01.000.39 € 18,90

**21CR (RL 100)**  
> Olio POE 100, 1 lt  
> POE 100 Oil, 1 lt



Cod. 01.000.252 € 20,90

**PAG PREMIUM**  
> Olio PAG PREMIUM, 1 lt, per impianti R134a/HF01234yf  
> PAG PREMIUM Oil, 1 lt, for R134a/HF01234yf a/c systems



Cod. 01.000.253 € 23,90

**PAG PREMIUM + ADDITIVE**  
> Olio PAG PREMIUM con ADDITIVO, 1 lt, per impianti R134a/HF01234yf  
> PAG PREMIUM Oil with ADDITIVE, 1 lt, for R134a/HF01234yf a/c systems



Cod. 01.000.254 € 22,00

**ADDITIVE**  
> Additivo universale, 250 ml, per impianti R134a/HF01234yf  
> Universal additive, 250 ml, for R134a/HF01234yf a/c systems



Cod. 01.000.255 € 22,70

**ADDITIVE**  
> Kit 12 siringhe, 7,5 ml con l'additivo universale + 2 adattatori (R134a /HF01234yf)  
> Kit 12 syringes, 7,5 ml with the universal additive + 2 adapters (R134a / HF01234yf)



Cod. 01.000.37 € 8,40

**AV 68R**  
> Olio per pompa a vuoto, 0,5 lt  
> Vacuum pump oil, 0,5 lt



Cod. 01.000.242 € 27,50

**COOL-SHOT ULTRA**  
> ADDITIVO per impianti di refrigerazione e condizionamento  
> PERFORMANCE ENHANCER for air conditioning and refrigeration systems



Cod. 01.000.241 € 29,50

**EXTREME ULTRA**  
> TURAFALLE ad alte prestazioni per impianti A/C  
> High performance innovative LEAK STOP for vehicles A/C system

HYBRID



Cod. 01.000.125 € 29,50

**21CR POE100**  
> Olio per compressori IBRIDI, 1lt  
> Oil for HYBRID compressors, 1lt



Cod. 01.000.124 € 29,90

**ADDITIVE**  
> Tracciante fluorescente U/V per impianti A/C vetture IBRIDE, 350 ml, senza solventi  
> U/V leak detector dye for A/C systems for HYBRID vehicles, 350 ml, solvent free



Cod. 01.000.127 € 38,50

**ADDITIVE**  
> Tracciante fluorescente U/V per impianti A/C vetture IBRIDE, 12 x 7,5 ml, con adattatore, senza solventi  
> U/V leak detector dye for A/C systems for HYBRID vehicles, 12 x 7,5 ml, with adapter, solvent free



Cod. 01.000.167 Prezzo a richiesta Price on request

> Refrigerante R134a in bombole da 12 kg ricaricabili  
> Refrigerant R134a (refillable 12 kg bottles) secondo disponibilità/according to the availability



Cod. 01.000.01 € 4,20

> Adattatore 1/4 SAE per collegare la stazione A/C con la bombola gas R134a  
> Adapter for freon bottles 1/4 SAE to connect the station to the R134a bottle



Cod. 01.000.207 € 5,00

> Adattatore alta pressione 1/4F SAE per collegamento bombola ricaricabile R134a  
> High pressure adapter 1/4F SAE for the rechargeable R134a bottle



Cod. 01.000.187 Prezzo a richiesta Price on request

> Bombola ricaricabile per HF01234yf con 5 kg di gas, attacco rapido incluso  
> Refrigerant HF01234yf in refillable 5 kg bottle, rapid coupling included secondo disponibilità/according to the availability



Cod. 01.000.208 € 9,90

> Adattatore per bombola ricaricabile HF01234yf  
> Adapter for the HF01234yf bottle

SA  
NI  
TA  
Z  
I  
O  
N  
I  
S  
T  
I  
C  
O  
N  
E

# PRAESIDIUM SALUTIS

MARCO **TOOLS**  
BY SPIN

PRODOTTI PER LA SANIFICAZIONE E PROTEZIONE PERSONALE  
SANITATION AND PERSONAL PROTECTION PRODUCTS

#ozonizzatori  
#nebulizzatori  
#atomizzatore



#lampade uv  
#box uv

#mascherine  
#barriere protettive  
#dispenser  
sanificanti



#purificatori d'aria  
#liquidi disinfettanti



#termometri  
#vasche u/s



Cod. 01.000.308

€ 435,00

**GENERATORE DI "NEBBIA" IGIENIZZANTE** per ambienti civili e automotive  
**SANITIZING "FOG" GENERATOR** for civil and automotive environments  
**GENERADOR DE "NIEBLA" DESINFECTANTE** para entornos civiles y automotive



IL PIÙ RAPIDO SISTEMA IGIENIZZANTE PER GRANDI AMBIENTI!!!

THE FASTEST SANITIZING SYSTEM FOR LARGE ROOMS!!!



**CARATTERISTICHE TECNICHE**

- Capacità erogazione: 500 m<sup>3</sup>/min
- Preriscaldamento: 6 min
- Alimentazione: 240V 50Hz
- Potenza: 1000W
- Cavo comando a distanza: 9 mt
- Dimensioni: 385x270x247mm
- Peso: 5,8 kg
- Serbatoio: 1,35 lt

• Bassi costi di sanificazione € 1,15 per ogni minuto di lavoro

• Dotato di telecomando a distanza (9 metri)

• È possibile operare anche in presenza di persone addette e/o animali

• L'attrezzo deve essere usato solo da personale professionale e addestrato

• Il dispositivo è per un uso intermittente

• Il livello del liquido necessario deve essere controllato prima di ogni sanificazione

• Un operatore professionale deve essere presente durante il trattamento, l'unità non deve restare incontrollata

• Lasciare l'apparecchio con almeno 50cm da persone o cose attorno

**TECHNICAL FEATURES**

- Supply capacity: 500 m<sup>3</sup>/min
- Warm-up time: 6 min
- Power supply: 240V 50Hz
- Power: 1000W
- Remote control cable: 9 mt
- Dimensions: 385x270x247mm
- Weight: 5.8 kg
- Tank capacity: 1.35 lt

• Low sanitation costs: € 1.15 per minute of work

• It is also possible to operate in the presence of personnel and/or animals

• The tool must only be used by professional and trained personnel

• The device is for intermittent use

• The level of the necessary liquid must be checked before each sanitization

• A professional operator must be present during the treatment, the unit must not remain uncontrolled

• Leave the device with at least 50cm from people or things around

Cod. 01.000.309

€ 66,50

**LIQUIDO IGIENIZZANTE, 5LT**  
**SANITIZING LIQUID, 5LT**  
**LÍQUIDO HIGIENIZANTE, 5LT**



**PROTEZIONE PER IL VISO • FACE SHIELD**

Cod. 01.000.279

€ 1,95



- Protezione per il viso
- Fornisce una visione chiara
- Buona funzione anti-appannamento
- Misura: 32x22 cm
- Weight: 39 gr
- Min. ordine 10 pz\*
- non sterilizzata

- Face shield
- Provides a clear view
- Good anti-fog function
- Dimension: 32x22 cm
- Weight: 39 gr
- Min. order 10 pcs\*
- not sterilized



Cod. 01.000.281 € 159,00

**NEBULIZZATORE ELETTRICO A BATTERIA, 16 L**  
**ELECTRIC BATTERY-OPERATED SPRAYER, 16 L**

- Batteria al litio rimovibile: 18 V 2,5 Ah
- Pressione di esercizio: 5 bar
- Orario di lavoro: 100 min
- Tempo di ricarica: 150 min
- Cinturino comodo
- Grilletto pesante
- Lancia di metallo
- Dimensioni imballo: 36,5x27x55 cm
- Peso: 3,5 kg
- **INCLUSO: CARRELLO COD. 01.000.281/C**

- Removable lithium battery: 18V 2,5 Ah
- Working pressure: 5 bar
- Working time: 100 min
- Charging time: 150 min
- Comfortable strap
- Heavy duty trigger
- Metal lance
- Pack. dimensioni: 33x57x20cm
- Weight: 3,5kg
- **INCLUDED: TROLLEY COD. 01.000.281/C**



Cod. 01.000.278 € 34,00

**NEBULIZZATORE PORTATILE, 16 L**  
**PORTABLE SPRAYER, 16 L**

- Nebulizzatore portatile da 16 lt di capacità con pompa a mano e sonda in fibra di vetro
- Portable 16 liter capacity nebulizer with hand pump and fiberglass probe



**PRODOTTO CONSIGLIATO**  
**RECOMMENDED PRODUCT**

Cod. 01.000.280 € 31,50



**SaniBact**

> Disinfettante, 1L  
Diluito in acqua 1:25

> Liquid disinfectant, 1L  
Diluted in water 1:25



Num. Reg. Min. 20145

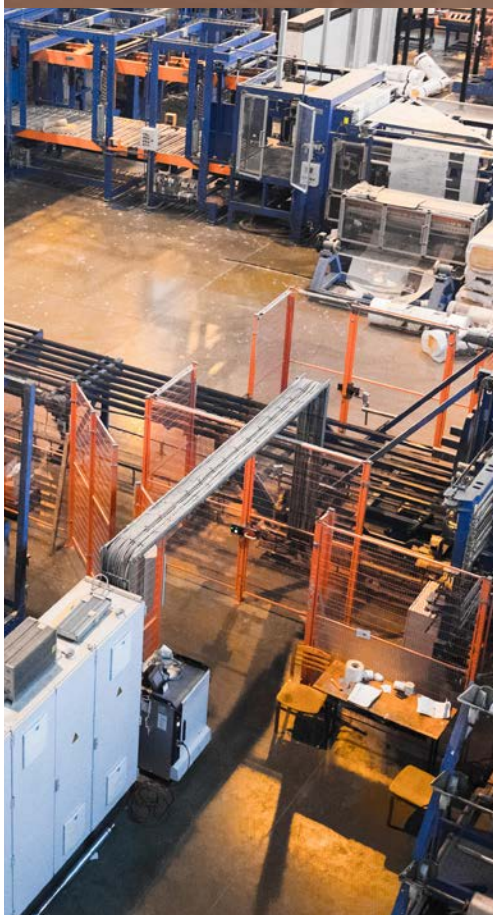

PROMO 2022/2

Cod. 01.000.283E

€ 282,00

## PUREZONE HOME

ATOMIZZATORE PER LA DISINFEZIONE DI AMBIENTI  
DESINFECTANT ATOMIZER FOR ROOMS



### CARATTERISTICHE TECNICHE

- Touch screen LCD
- Capacità: 13L
- Timer fino 12 ore
- Selezione dimensione gocce
- Selezione grado di umidità richiesto
- Quantità di nebulizzazione: ≤ 1800 ml / h
- Area di applicazione: 80-120m<sup>2</sup>
- Telecomando
- Dimensioni: 30x39x60cm
- Peso: 5 kg

### TECHNICAL FEATURES

- LCD touch screen
- Tank capacity: 13L
- Timer: up to 12 h
- Adjustable droplet dimension
- Humidity level selection
- Nebulization quantity: ≤ 1800 ml / h
- Application area: 80-120m<sup>2</sup>
- Remote control
- Dimensions: 30x39x60cm
- Weight: 5 kg

### PUREZONE HOME Kit include:

- 10lt di liquido igienizzante **ECASAN**, diluibile al 50% in acqua demineralizzata

### PUREZONE HOME Kit includes:

- 10lt of sanitizing liquid **ECASAN**, 50% dilution in demineralized water

Cod. 01.000.306

€ 49,00

## ECASAN

> Liquido sanificante per atomizzatore, 5 lt  
> Hygienizing liquid for u/s atomizer 5 lt



5+5 LT  
INCLUSI

## ATOM MACHINE



Cod. 01.000.286 € 145,00

ATOM MACHINE è un'apparecchiatura elettronica ad ultrasuoni che genera istantaneamente la nebulizzazione di un liquido igienizzante che si propaga nell'ambiente e nel sistema di ricircolo dell'Impianto A/C da igienizzare sanificando l'aria e tutte le superfici presenti.

La caratteristica principale del Sistema di Nebulizzazione per ultrasuoni consiste nell'ottenere particelle nebulizzate di liquido a temperatura ambiente, evitando il fenomeno della condensazione che si verifica diversamente quando un liquido è nebulizzato per riscaldamento. Le particelle di ATOM ULTRA così ottenute hanno una dimensione inferiore ai 5 µm e si propagano perfettamente nell'ambiente e nell'Impianto di A/C.

**Un ciclo di trattamento igienizzante con ATOM ULTRA dura circa 30 minuti a 20°C e si ferma automaticamente.**

Il tempo di esposizione è stato studiato per garantire che un'ambiente di 20 mq o tutte le parti dell'impianto vengano raggiunte, l'ambiente venga saturato e gli attivi abbiano il giusto tempo di contatto per garantire una buona igienizzazione.

ATOM MACHINE is an electronic ultrasound device that instantly generates the nebulization of a sanitizing liquid that propagates in the environment and in the recirculation system of the A/C system to be sanitized by hygienisation of the air and all the surfaces present.

The main feature of the Ultrasonic Nebulization System consists in obtaining atomized particles of liquid at room temperature, avoiding the phenomenon of condensation that occurs differently when a liquid is atomized by heating. The ATOM ULTRA particles thus obtained have a size of less than 5 µm and perfectly propagate in the environment and in the A / C system.

**A sanitizing treatment cycle with ATOM ULTRA lasts about 30 minutes at 20°C and stops automatically.**

The exposure time has been studied to ensure that an environment of 20 m<sup>2</sup> or all parts of the system are reached, the environment is saturated and the active ingredients have the right contact time to guarantee good sanitation.

### ATOM MACHINE KIT include:

- Nebulizzatore ATOM MACHINE
- 48 ricariche ATOM ULTRA da 120 ml (al profumo di limone)



PROMO 2022/2

### ATOM MACHINE KIT includes:

- ATOM MACHINE nebulizer
- 48 bottles ATOM ULTRA, 120 ml (lemon-scented)



Cod. 01.000.297 € 47,00



> ATOM ULTRA ricariche al profumo di limone, (liquido sanificante per nebulizzatore Atom Machine), 12 pz x 120 ml

> ATOM ULTRA lemon-flavored refills (purifying treatment for Atom Machine nebulizer), 12 pcs x 120 ml

Cod. 01.000.286.R2 € 32,00



> Alimentatore 220V per Atom Machine  
> 220V power supply for Atom Machine

**OZONIZZATORI PORTATILI**  
**PORTABLE OZONE GENERATORS**  
**GENERADORES DE OZONO PORTÁTILES**



Esempio di calcolo tempo di sanificazione di una stanza:

$volume\ 3x4x3mt = 36m3$

$Tempo: 36/2 = 18\ minuti$

Calculation example of the necessary time for a deep cleaning of a room:  $volume\ 3x4x3mt = 36m3$

$Time: 36/2 = 18\ minutes$

Ejemplo de cálculo del tiempo necesario para una limpieza profunda de una habitación:  $volumen\ 3x4x3mt = 36m3$

$Tiempo: 36/2 = 18\ minutos$

**Cosa è l'ozono?**

L'ozono (O<sub>3</sub>) è un gas dal caratteristico odore agliaceo, le cui molecole son formate da 3 atomi di ossigeno. E' un potente agente antimicrobico che grazie alla sua azione ossidante è in grado di rendere inattivi batteri, muffe, lieviti, parassiti e virus.

**Cosa può fare l'ozono?**

L'azione deodorante e disinfettante dell'ozono dipende dalla sua forte capacità ossidante che a livello gassoso offre molti vantaggi. L'ozono purifica l'aria ed elimina totalmente gli odori sgradevoli.

**Benefici:**

- Elimina completamente gli odori dagli ambienti e dalle superfici (autoveicoli, imbarcazioni, abitazioni, celle frigorifere, ecc.)
- Efficace contro l'odore di tabacco
- Efficace contro l'odore di cibo e animali
- Uccide rapidamente tutti i microrganismi (virus, batteri, spore, muffe, parassiti e protozoi, ecc.)
- Non necessita di manutenzione ordinaria e di nessun apporto di manodopera, di nessun prodotto o materiale di consumo
- Non utilizza sostanze dannose per l'ambiente e non lascia residui (si decompone in O<sub>2</sub>)

**Applicazioni:**

La bonifica degli ambienti deve essere compiuta in totale assenza di persone o animali domestici usando un ventilatore per la diffusione.

**What is ozone?**

Ozone (O<sub>3</sub>) is a gas with a typical garlic-like smell whose molecules are made of 3 atoms of oxygen. It is a powerful anti-microbial that thanks to its oxidizing action it can deactivate bacteria, molds, yeasts, parasites and viruses.

**What can ozone do?**

The deodorizing and disinfectant action of the ozone depends on its strong oxidizing capacity which at a gaseous state offers many advantages. Ozone purifies air and eliminates any unpleasant smells.

**Benefits:**

- It completely eliminates odors from spaces and surfaces (vehicles, boats, houses, cold storage, etc.)
- Efficient against tobacco smell
- Efficient against food and animals smell
- It rapidly kills all microorganisms (viruses, bacteria, spores, molds)
- It does not need any ordinary maintenance or labor work, nor any product or consumables
- It does not use any substance dangerous for the environment nor it leaves any residuals (it breaks down in O<sub>2</sub>)

**Applications:**

The cleaning of the environment must be carried out in total absence of people or pets and by using a fan to spread the ozone.



**Cod. 01.000.299**





Prezzo a richiesta  
Price on request

**OZONIZZATORE PORTATILE ARIA-ACQUA**  
**AIR-WATER OZONE MAKER**  
**OZONIZADOR PORTÁTIL AIRE-AGUA**

- Idoneo sia per il trattamento dell'acqua che dell'aria. Effetto sterilizzante e deodorante.
- Tubo in silicone da un metro e 2 ugelli per il trattamento dell'acqua.
- Tubo di ozono da 2,4 g con elettrodo in acciaio inossidabile, stabile e ad alte prestazioni
- Timer di 3 ore per controllare il tempo di purificazione
- Alimentazione e pompa dell'aria incorporata: 10 l/min
- Per l'uso con acqua: posizionare l'ugello dell'aria nell'acqua per ozonizzare
- With 1 mt silicone tube and 2 air nozzles for water treatment
- Both for water and air treatment
- Portable Design: Small and compact, convenient to use anywhere
- 2.4g ozone tube with stainless steel electrode, stable and high performance
- 3 hours timer to control purification time
- Air feed and built-in air pump: 10L/min
- For water application: place the air nozzle in the water to ozonize it



OZONIZZATORI PORTATILI • PORTABLE OZONE GENERATORS • GENERADORES DE OZONO PORTÁTILES

MODELLI DISPONIBILI MODELS AVAILABLE MODELOS DISPONIBLES						
	<b>Cod. 01.000.215</b>	<b>Cod. 01.000.215W</b>	<b>Cod. 01.000.269</b>	<b>Cod. 01.000.224</b>	<b>Cod. 01.000.224L</b>	<b>Cod. 01.000.257</b>
Capacità Capacity Capacidad	<b>3,5 gr/h</b>	<b>5 gr/h</b>	<b>4 gr/h</b> pacco ceramico sostituibile da esterno replaceable ceramic ozone module	<b>3,50 ÷ 7 gr/h</b> Con potenza regolabile with adjustable power con potencia ajustable	<b>10 gr/h</b>	<b>5/10/15/20 gr/h</b> Con potenza regolabile with adjustable power con potencia ajustable
Timer Temporizador	2 ore/hours/horas	2 ore/hours/horas	3 ore/hours/horas	2 ore/hours/horas 12 ore a richiesta/hours on request horas bajo solicitud	2 ore/hours/horas	<b>135 min</b> con timer digitale with digital timer con temporizador digital
Rumorosità / Noisiness Ruido	<40dB	<40dB	<40dB	<40dB	<40dB	<40dB
Alloggiamento Housing Alojamiento	Cabinet in acciaio verniciato Cabinet made of painted steel Alojamiento de acero pintado	Cabinet in acciaio verniciato Cabinet made of painted steel Alojamiento de acero pintado	Cabinet in acciaio verniciato Cabinet made of painted steel Alojamiento de acero pintado	Cabinet in acciaio inossid. Stainless steel cabinet Alojamiento en acero inoxidable	Cabinet in acciaio verniciato Cabinet made of painted steel Alojamiento de acero pintado	Cabinet in acciaio inossid. Stainless steel cabinet Alojamiento en acero inoxidable
Potenza/Power/Potencia	65W	65W	50W DC/AC	100W	100W	270W
Dimensioni Dimensions Dimensiones	205x175x150 mm	205x175x150 mm	205x175x150 mm	210x180x260 mm	210x180x260 mm	202x379x285 mm
Volume flusso aria Airflow volume Volumen del flujo de aire	2,5 m³/min	2,5 m³/min	2,5 m³/min	2 ÷ 4 m³/min	2 ÷ 4 m³/min	4,8 m³/min
Peso netto-lordo Net-gross weight Peso neto-bruto	2Kg/2,6Kg	2Kg/2,6Kg	2Kg/2,6Kg	2,9Kg/3,9Kg	2,9Kg/3,9Kg	6,2Kg/7,6Kg
Alimentazione: Power supply: Alimentación:	220/240V	220/240V	<b>BIPOWER</b> 12V DC 120÷240V AC	220/240V	220/240V	210/230V
Trattamento aria Air treatment Tratamiento de aire	✓	✓	✓	✓	✓	✓
Telecomando Remote control Control remoto	—	—	—	—	—	✓
<b>Prezzo promo: Promo price:</b>	<b>€ 84,<sup>30</sup></b>	<b>€ 86,<sup>50</sup></b>	<b>€ 115,<sup>00</sup></b>	<b>€ 162,<sup>00</sup></b>	<b>€ 203,<sup>00</sup></b>	<b>€ 262,<sup>00</sup></b>

PROMO 2022/2



**Areare completamente l'ambiente  
bonificato prima di accedervi**

**Ventilate completely the area after  
sanification and before entering**

**Ventile completamente el área después  
de la higienización y antes de entrar**

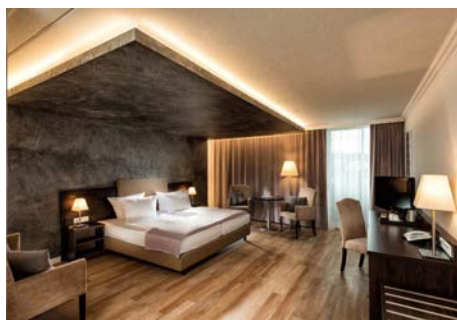

PURIFICATORE D'ARIA • UV HUMIDIFIER AIR PURIFICATION

**PURIFICATORE D'ARIA**  
con azione germicida a raggi uv-c

**UV HUMIDIFIER AIR PURIFICATION**  
with germicidal action

Cod. 01.000.300

€ 327,00



**AZIONE ANTIBATTERICA DEI RAGGI ULTRAVIOLETTI**

su acari, muffe, batteri e virus (20 milioni di ioni/cm<sup>2</sup>).

**THE ANTIBACTERIAL ACTION OF ULTRAVIOLET RAYS**

on mites, molds, bacteria and viruses (20 million ions / cm<sup>2</sup>)

**CARATTERISTICHE TECNICHE**

- Capacità di trattamento aria: 488 m<sup>3</sup>/h
- Ideale per ambienti da 34 a 58m<sup>2</sup>
- Allarmi: filtro intasato, blocco per bambini, analizzatore pm 2.5, touch screen e WiFi standard
- Filtri interni: alluminio (lavabile), catalitico, antibatterico, carboni attivi e HEPA.
- Sterilizzatore con UV-C a 365 nm

**TECHNICAL FEATURES**

- Air treatment capacity: 488 m<sup>3</sup>/h
- Ideal for rooms from 34 to 58m<sup>2</sup>
- Alarms: clogged filter, child lock, pm 2.5 analyzer, touch screen and standard WiFi
- Internal filters: aluminum (washable), catalytic, antibacterial, activated carbon and hepa.
- UV-C / 365 nm sterilizer

**FILTRAGGIO DELLE PARTICELLE PM 2.5 FINO AL 99,99%**

**PARTICLE FILTERING PM 2.5 UP TO 99.99%**

Cod. 01.000.300.R1

€ 10,00

Filtro antipolline (K08EF1)

Cod. 01.000.300.R2

€ 40,00

- > 2 filtri (carboni attivi + HEPA)
- > Carbon + HEPA filters, 2 pcs

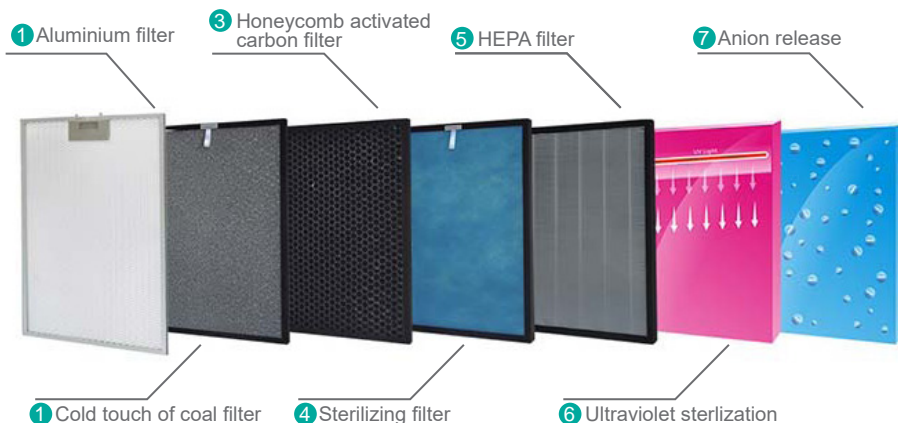



**FUNZIONE "NEBULIZZATORE"**  
per liquidi sanificanti e/o profumanti  
**"NEBULIZER" FUNCTION**  
for sanitizing and / or perfuming liquids

- l'apparecchio è dotato di vaschetta porta liquido ad ultrasuoni per nebulizzare prodotti sanificanti e profumanti
  - con comando a distanza e 5 gradi di filtraggio) con indicatore digitale dell'intasamento
  - con comando tramite smartphone, scaricando l'app SmartLife
  - Dimensions: 400x230x620mm
  - Weight: 13.6kg
  - Power supply: 110 ÷ 265V / 50Hz 85W
- the device is equipped with an ultrasonic liquid holder to nebulize sanitizing and perfuming products
  - with remote control and 5 degrees of filtering) with digital clogging indicator
  - Use of the app SmartLife to smart control with the smartphone
  - Dimensions: 400x230x620mm
  - Weight: 13,6kg
  - Power supply: 110 ÷ 265V/50Hz 85W

**Smart Life App**

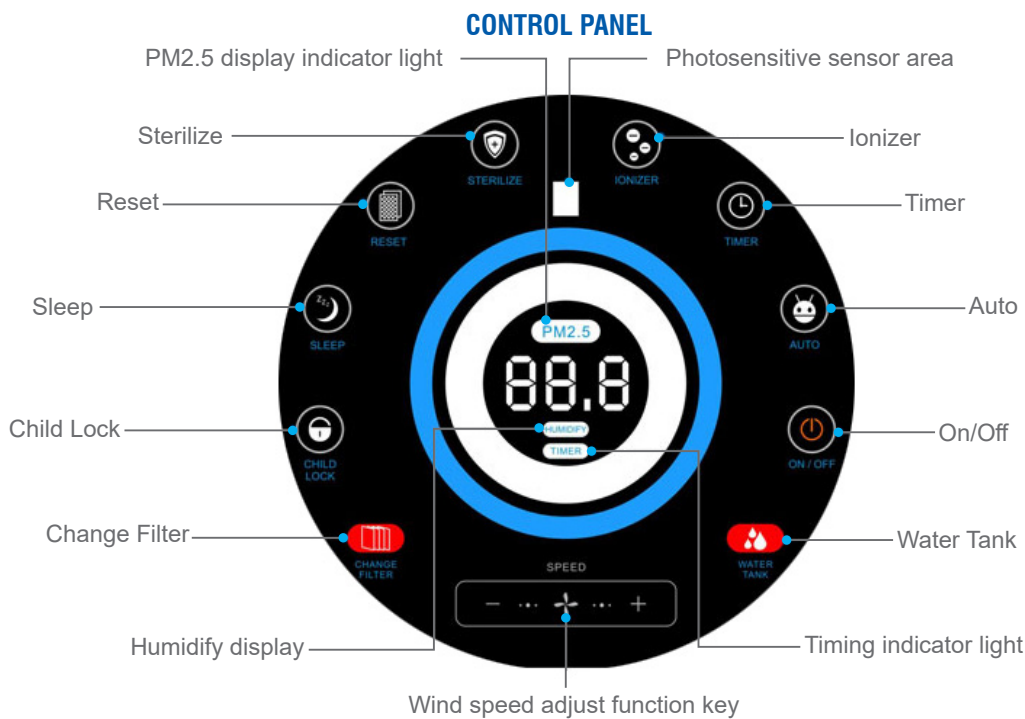

**REGOLAZIONE AUTOMATICA DEL FLUSSO ARIA**

a seconda del grado di contaminazione

**AUTOMATIC REGULATION OF THE AIR FLOW**

according to the degree of contamination



- L'ampio display riporta l'analizzatore del tasso di Pm 2.5, il timer, il pulsante attivazione uv-c, indicatori di livello dell'acqua nel serbatoio e la regolazione del flusso d'aria (automatico a seconda del livello di contaminazione rivelata (rosso – alto, giallo – medio, verde – basso)
- The large display shows the Pm 2.5 rate analyzer, the timer, the uv-c activation button, water level indicators in the tank and the air flow regulation (automatic according to the level of contamination detected (red - bad, yellow - ordinary, green - good)

DISPOSITIVI DI STERILIZZAZIONE A RAGGI UV-C • ULTRAVIOLET STERILIZATION DEVICES

Cod. 05.073.47

€ 62,00

UV LAMP



INNOVATIVA LAMPADA DISINFETTANTE A RAGGI UV-C  
INNOVATIVE UV-C DISINFECTANT LAMP

- Con 18 led, batteria ricaricabile 3,7V 2000mAh
- Idonea per sterilizzare mascherine, cellulari, tastiere, abiti, piani di lavoro, divani, letti, sanitari, gioielli, oggetti per la cura della persona
- In meno di 1 minuto abbattimento del 99,9% di batteri
- Spegnimento automatico se rivolto verso il viso o corpo
- Ricarica automatica con cavo mini USB
- 1° carica: 4-5h; autonomia 3H
- 18 LEDs, 3.7V, 2000mAh rechargeable battery
- Suitable for sterilizing masks, cell phones, keyboards, clothes, worktops, sofas, beds, sanitary ware, jewelry, personal care items
- In less than 1 minute, 99.9% killing of bacteria
- Automatic shutdown if facing towards the face or body
- Automatic charging with mini USB cable
- First charge: 4-5h; 3h autonomy

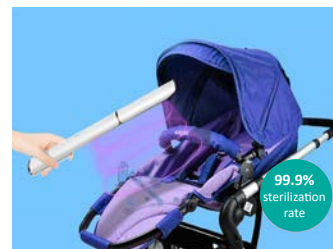

Cod. 05.073.48

€ 29,90

UV BOX

BOX DI STERILIZZAZIONE A RAGGI UV-C  
UVC LIGHT STERILIZATION BOX



- **Multifunzionale:** idoneo per smartphone, giocattoli, occhiali, spazzolini, chiavi, gioielli e piccoli oggetti.
- Agisce anche come profumatore oltre che sanificatore
- Raggi UV-C
- Il tasso battericida è fino al 99,9% utilizzando la banda d'onda di sterilizzazione ad alta efficienza UV-C 253,7nm
- Potenza totale: 6W
- Batterie ricaricabili
- Dimensioni: 227x125x50mm
- Peso: 337 gr
- **Multifunctional:** suitable for smartphones, toys, glasses, toothbrushes, keys, jewelry and small objects.
- It also acts as a perfumer as well as sanitizer
- UV-C rays
- The bactericidal rate is up to 99.9% by using high efficiency sterilization wave band UV-C 253.7nm
- Total power: 6W
- Rechargeable batteries
- Dimensions: 227x125x50mm
- Weight: 337 gr



## SICUREZZA ALIMENTARE • FOOD SAFETY SYSTEM

## HACCP

HAZARD ANALYSIS AND CRITICAL CONTROL POINT

## Cos'è il piano HACCP?

È un insieme di documenti e regole di prevenzione da mettere in atto per ogni azienda della filiera **ALIMENTARE**.

È un elemento obbligatorio per lavorare in sicurezza e in osservanza delle normative stabilite dal regolamento CE 852/2004.

## Per chi è obbligatorio il piano HACCP?

È obbligatorio per le 3 grandi categorie:

- **A: Preparazione, produzione e confezionamento** (macellerie, panifici, laboratori alimentari)
- **B: Trasporto, deposito, stoccaggio e distribuzione** (distributori automatici alimentari/bevande, magazzini, trasporto alimentari)
- **C: Commercio, somministrazione, vendita** (ristoranti/bar, supermercati, banchi di frutta etc., erboristerie e farmacie che vendono farmaci, medicine e dispositivi medicanti che necessitano di trattamento di temperature particolari)

## What is HACCP?

It is a set of documents and prevention rules to be implemented for each company in the **FOOD CHAIN**.

It is a mandatory element to work in safety and in compliance with the regulations established by the EC regulation 852/2004.

## For whom is the HACCP plan mandatory?

It is mandatory for the 3 main categories:

- **A: Preparation, production and packaging** (butchers, bakeries, food laboratories)
- **B: Transport, storage, storage and distribution** (food / drink vending machines, warehouses, food transport)
- **C: Commerce, administration, sale** (restaurants/bars, supermarkets, fruit shops etc., herbalists and pharmacies that sell drugs, medicines and medical devices that need to treat them under particular temperatures)

DISINFETTANTE CONCENTRATO BATTERICIDA E LEVURICIDA (NUM. REG. MIN. 20145)  
LIQUID DISINFECTANT FOR SURFACES WITH BACTERICIDE AND VIRUCIDAL EFFICACY

## SANIBACT, 1L



Cod. 01.000.280

€ 31,50

- Disinfettante **Presidio Medico Chirurgico** (Num. Reg. Min. 20145)
- Uccide germi e batteri garantendo la disinfezione profonda di evaporatori, canali di areazione e di tutte le superfici
- Efficace contro i virus di influenza, epatite B/C, HIV, rota virus, noro virus e ebola virus. Per i batteri supera i test EN1276 - EN13697. Per le muffe supera i test EN13697
- È un prodotto estremamente concentrato: necessita di una **diluizione pari a 1:25**. (con 1 Litro di Sanibact si ottengono 25 Litri di disinfettante pronto all'uso)
- Può essere utilizzato anche su superfici a contatto con alimenti (in questo caso è necessario risciacquare la superficie trattata dopo l'applicazione). **Idoneo per il piano HACCP**
- Agisce in soli 5 minuti
- Garantisce un profondo livello di disinfezione

HACCP  
PRODUCT

Num. Reg. Min. 20145

- Disinfettante **Presidio Medico Chirurgico** (Reg. Min. 20145); reg. in Germany with authorization no. 69542; reg. in Poland with nr. 6979/17
- It kills germs and bacteria by ensuring the deep disinfection of evaporators, ventilation channels and all surfaces
- Effective against influenza viruses, hepatitis B / C, HIV, rota virus, noro virus and ebola virus. For bacteria it passes the EN1276 - EN13697 tests. For molds it passes the EN13697 tests
- It is an extremely concentrated product: it needs a **1:25 dilution**. (with 1 liter of Sanibact you get 25 liters of ready-to-use disinfectant)
- It can also be used on surfaces in contact with food (in this case it is necessary to rinse the treated surface after application). **Suitable for the HACCP plan**.
- It works in just 5 minutes
- It guarantees a deep level of disinfection

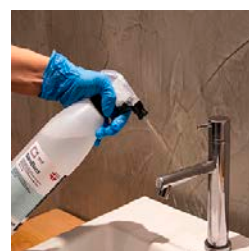

Cod. 01.000.276

13,00

**POTENTE IGIENIZZANTE A BASE DI ALCOOL 80%**

per superfici in bombola spray da 400 ml - idoneo per tutte le superfici

**POWERFUL 80% ALCOHOL-BASED SANITIZER**

for surfaces in 400 ml spray can - suitable for all surfaces

**CleanSi**HACCP  
PRODUCT

**CLEANSI** grazie al suo elevato contenuto di alcool all'80% garantisce un profondo livello di igienizzazione. Evapora rapidamente e completamente senza lasciare residui e aloni.

**E' LA SOLUZIONE IDEALE PER L'IGIENIZZAZIONE DI:**

**Ambienti domestici e uffici:** maniglie, sedie, tavoli, tavoli in vetro, mazzi di chiavi, telecomandi e schermi TV, smartphone e tablet, console videogiochi, giocattoli, suppellettili, tasti ascensore, accessori bagno, piani di lavoro in cucina e piccoli elettrodomestici, corrimano e serramenti. E' adatto anche per la pulizia di vetri, lenti (anche di occhiali) e superfici in vetro.

**Autoveicoli:** spruzzato direttamente su maniglie, cruscotti, leve del cambio, volante. Filtri e condotti di ventilazione degli impianti di climatizzazione.

**RIMUOVE GERMI E ALLERGENI**

CleanSi rimuove germi, allergeni (provenienti da acari della polvere, cani, gatti, pollini), polvere e sporco ambientale. Può essere utilizzato anche per pulire e igienizzare filtri e condotti di ventilazione degli impianti di climatizzazione eliminando i microorganismi che pregiudicano la qualità e la salubrità dell'aria immessa negli ambienti o negli abitacoli.

**RAPIDO ED EFFICACE**

Il trattamento igienizzante CleanSi è rapido ed efficace e rilascia un fresco profumo di pulito. CleanSi è un prodotto idoneo per il piano HACCP, può quindi essere utilizzato anche sulle superfici a contatto con gli alimenti.

**CLEANSI** thanks to its high alcohol content of 80% guarantees a deep level of sanitation. It evaporates quickly and completely without leaving residues and streaks.

**IT IS THE IDEAL SOLUTION FOR THE SANITATION OF:**

**Home environments and offices:** handles, chairs, tables, glass tables, bunches of keys, remote controls and TV screens, smartphones and tablets, video game consoles, toys, furnishings, elevator keys, bathroom accessories, kitchen worktops and small appliances, handrails and frames. It is also suitable for cleaning glass, lenses (including glasses) and glass surfaces.

**Vehicles:** sprayed directly on handles, dashboards, shift levers, steering wheel.

Filters and ventilation ducts of air conditioning systems.

**REMOVES GERMS AND ALLERGENS**

CleanSi removes germs, allergens (from dust mites, dogs, cats, pollens), dust and environmental dirt. It can also be used to clean and sanitize filters and ventilation ducts of air conditioning systems by eliminating microorganisms that affect the quality and healthiness of the air introduced into the rooms or interiors.

**QUICK AND EFFECTIVE**

The CleanSi sanitizing treatment is quick and effective and releases a fresh clean scent. CleanSi is a product suitable for the HACCP hob, therefore it can also be used on surfaces in contact with food.



**PRODOTTI PER IL LAVAGGIO E LA MANUTENZIONE DI SPLIT PER ARIA CONDIZIONATA**  
**PRODUCTS FOR WASHING AND MAINTENANCE OF A/C SPLITS**

Cod. 01.000.282 € **12,95** **CHINOOK, 1L**

**PULITORE PER FILTRI A/C UNITÀ INTERNE**  
**CLEANER FOR INDOOR A/C FILTERS**

È un efficace pulitore per i filtri di qualsiasi tipo di unità interna, non aggressivo per i loro materiali. Pulisce in modo rapido ed efficace, rimuovendo facilmente smog, polvere, muffe e contaminanti microbici e lasciando un piacevole profumo di pulito.

It is an effective cleaner for filters of any type of indoor unit, non-aggressive for their materials. It cleans quickly and effectively, easily removing smog, dust, mold and microbial contaminants and leaving a pleasant clean scent.



Cod. 01.000.284 € **12,29** **LUXEDO, 1L**

**PULITORE IGIENIZZANTE PROFUMATO per climatizzatori e superfici, 1L**  
**SCENTED SANITIZING CLEANER for air conditioners & surfaces, 1L**

- Rimuove germi, batteri e allergeni
- Rimuove residui organici, sporco ambientale e grasso
- Disinfettante registrato in Germania (N° 69541)
- Non necessita di risciacquo
- Profumato
- Removes germs, bacteria and allergens
- Removes organic residues, environmental dirt and grease
- German Registered Disinfectant (No. 69541)
- It does not require rinsing
- Scented



Cod. 01.000.294 € **15,57** **WALLY**

**COVER PER PULIZIA MINI-SPLIT**  
**MINI-SPLIT CLEANING COVER**



- WALLY è una cover in Polietilene (PE) trasparente riusabile che assicura la completa protezione dell'area attorno allo split durante le operazioni di pulizia.
- Grazie a WALLY il tecnico può pulire l'evaporatore e le sue batterie alettate con un disassemblaggio minimo, lasciando lo split a muro.
- La coulisse, infatti, garantisce la perfetta aderenza sui climatizzatori a parete di qualsiasi dimensione.
- Cleaner, acqua di risciacquo e sporco defluiranno nel secchio (non fornito), senza rischiare di danneggiare le superfici circostanti.

- WALLY is a reusable transparent polyethylene (PE) cover that ensures complete protection of the area around the split during cleaning.
- Thanks to WALLY, the technician can clean the evaporator and its finned batteries with minimal disassembly, leaving the wall split.
- The drawstring, in fact, guarantees perfect adherence to wall mounted air conditioners of any size.
- Cleaner, rinse water and dirt will flow into the bucket, without risking damaging the surrounding surfaces.



PROMO 2022/2

**BARRIERE ANTICONTAMINAZIONE BATTERICA per uffici, farmacie e pubblici esercizi**  
**BACTERIAL CONTAMINATION BARRIERS for offices (open spaces), pubs, restaurants etc.**

Modelli disponibili Available models	Cod. 05.088.114	Cod. 05.088.115 	Cod. 05.088.116	Cod. 01.000.295 
Dimensioni	1200x800 mm	1000x600 mm	750x660 mm	500x700 mm
Spessore Thickness	5 mm	4 mm	4 mm	4 mm
Foro passa fogli	✓	✓	✓	✓
Min. ordine Min. order	5 pz / pcs* indivisibili non-divisible	1 pz	12 pz / pcs* indivisibili non-divisible	5 pz / pcs* indivisibili non-divisible
Prezzo Promo Promo Price	€ <b>268,00*</b>	€ <b>72,00</b>	€ <b>370,00*</b>	€ <b>195,00*</b>

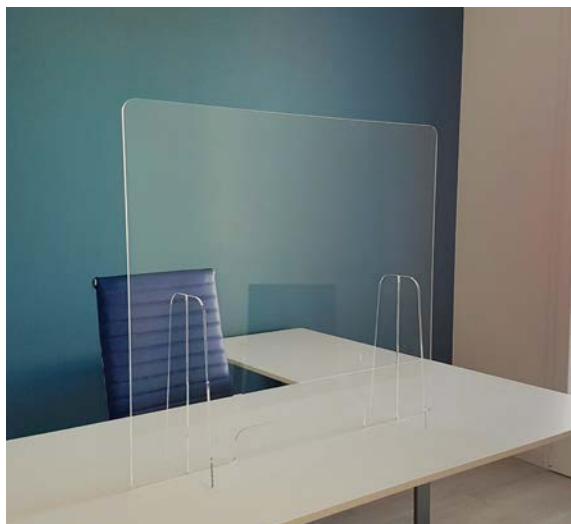

Cod. 05.088.117 € **80,00**

> Barriera ROLL-UP trasparente in acetato per separazione ingressi aree di passaggio/corridoi (1000 x 2000 cm)

> Transparent ROLL-UP barrier in acetate for separating entrances to passage areas / corridors (1000 x 2000 cm)

Cod. 01.000.296 € **68,00**

> Barriera anticontaminazione batterica in acetato e cartone pressato (struttura 580x780 mm; schermo 467x620 mm).

Min. ordine: 10 pz indivisibili\*

> Transparent ROLL-UP barrier in acetate for separating entrances to passage areas / corridors (1000 x 2000 cm)

Min. order: non divisible 10 pcs\*

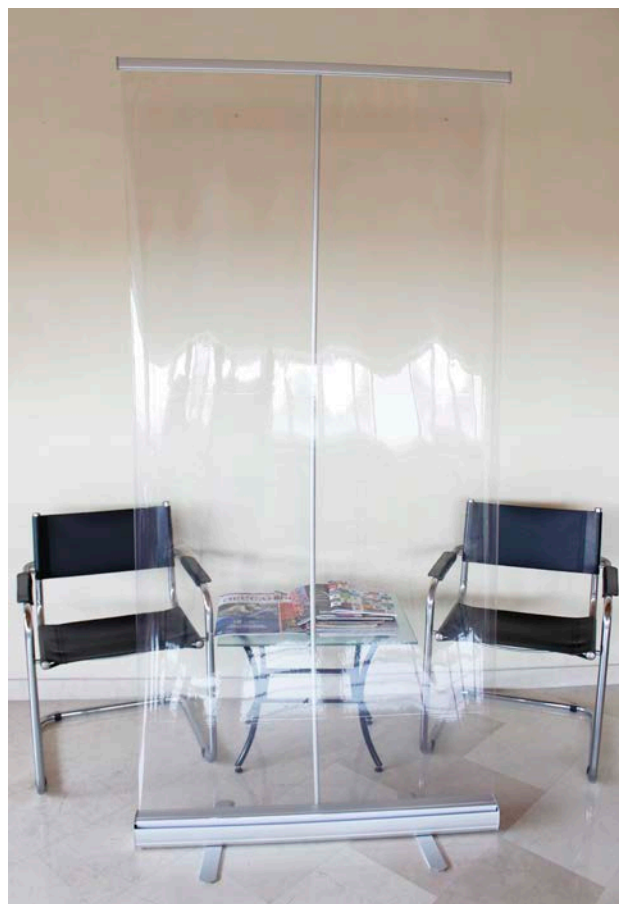



Cod. 04.052.06

€ 75,00

Prezzi netti per quantità  
Net prices for min. q.ty

**TERMOMETRO FRONTALE A PISTOLA (CORPO / SUPERFICI)**

digitale a infrarossi senza contatto

**FRONTAL GUN THERMOMETER (BODY / SURFACE)**

digital, with infrared, contactless

**TERMÓMETRO PISTOLA FRONTAL (CORPORAL / SUPERFICIAL)**

digital, con infrarrojos, sin contacto

- Temperatura di allarme automatica di  $\geq 38^{\circ}\text{C}$
- **Conforme EN 61000-6-1:2007, EN 61000-6-3:2007, A1:2011**
- Display grande, retroilluminato
- Velocità della misurazione: 0,5 secondi
- Distanza di misurazione: 5-15 cm
- Dimensioni del prodotto: 160x100x40mm
- Peso: 100g
- 2 batterie AAA (non incluse)
- Automatic alarm temperature at  $\geq 38^{\circ}\text{C}$
- **Compliant w. EN 61000-6-1:2007, EN 61000-6-3:2007, A1:2011**
- Large backlit display
- Time measurement sensitivity: 0.5 seconds
- Distance measurement: 5-15 cm
- Product dimensions: 160x100x40mm
- Weight: 100g
- 2 x AAA batteries (not included)
- Alarma automática de temperatura a  $\geq 38^{\circ}\text{C}$
- **Conforme con EN 61000-6-1:2007, EN 61000-6-3:2007, A1:2011**
- Pantalla grande retroiluminada
- Sensibilidad medición tiempo: 0.5 segundos
- Medida de distancia: 5-15 cm
- Dimensiones del producto: 160x100x40mm
- Peso: 100g
- 2 x pilas AAA (no incluidas)

temperatura CORPO / SUPERFICI  
BODY / SURFACE temperature  
temperatura CORPORAL / SUPERFICIAL



Cod. 04.013.05

€ 38,40

**TERMOMETRO DIGITALE A RAGGI INFRAROSSI**

con puntatore laser (-50°/+400°)

**DIGITAL INFRARED THERMOMETER**

with laser pointer (-50°/+400°)

**TERMÓMETRO DIGITAL DE RAYOS INFRARROJOS**

con puntador laser (-50°/+400°)

- |   |  |   |
|---|--|---|
| • Misura della temperatura senza contatto     | • Non-contact temperature measurement      | • Medición de la temperatura sin contacto |
| • Spegnimento automatico                      | • Auto Power Off                           | • Apagado automático                      |
| • Grado di emissività regolabile 0,95 (fisso) | • Adjustable emissivity: from 0,95 (fixed) | • Grado de emisión regulable 0,95 (fijo)  |
| • Rapporto distanza-dimensioni: 12:1          | • Distance spot ratio: 12:1                | • Relación distancia-dimensiones: 12:1    |
| • Data hold                                   | • Data hold                                | • Data hold                               |



Cod. 04.052.00

€ 8,50

**TERMOMETRO DIGITALE A PENNA -50°/+150°C**

DIGITAL PEN THERMOMETER -50°/+150°C

TERMÓMETRO TIPO BOLÍGRAFO DIGITAL -50°/+150°C



**ATTREZZATURE PER GOMMISTI  
TYRE SHOP EQUIPMENT  
EQUIPO DE TIENDA DE NEUMÁTICOS**

# TYRE SMART SCANNER



Cod. 04.014.03

€ 1.299,00





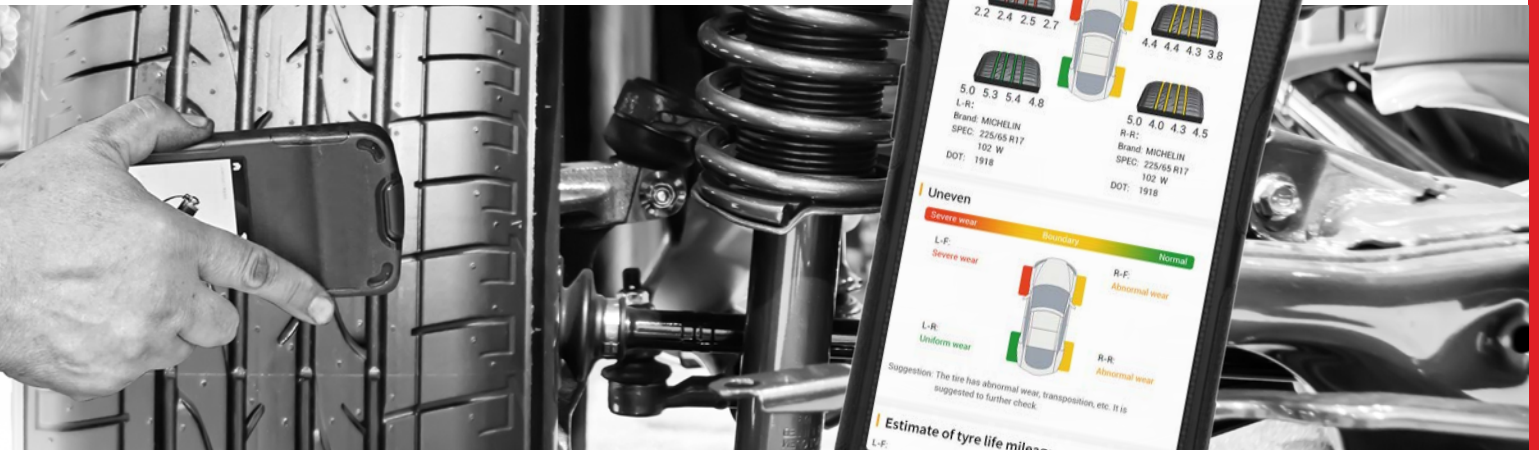

## SCANNER A FASCIO LASER PER PNEUMATICI

### HAND-HELD TYRE SMART SCANNER

for tire lifetime uneven wear analysis



PROMO 2022/2

-  **INTUITIVO**  
touch screen 5.45" e di facile lettura
  -  **COMPATTO ED ERGONOMICO**  
Simile alla dimensione del cellulare da 6"
  -  **RICONOSCIMENTO AUTOMATICO TARGA E NR. TELAIO**  
(Telecamera HD 16 milioni di pixel)
  -  **PROCESSO DI ISPEZIONE VELOCE**  
Ca. 60 sec. per vettura (4 ruote)
  -  **RETE FISSA**  
Supporto 4G, Wifi / Hot Spot
  -  **UN VERO DISPOSITIVO "SMART"**  
Supporto stampa A4, scansione codice QR, condivisione o invio e-mail/SMS
  -  **ANALISI DEI BIG DATA**
- EASY**  
5.45" touch screen and easy read
  - COMPACT AND ERGONOMIC DESIGN**  
Similar to 6" mobile size
  - AUTOMATIC LPR & VIN CODE RECOGNITION**  
16 Million HD camera with automatic license plate and VIN code recognition
  - FAST INSPECTION PROCESS**  
Ca. 60 seconds for 4-wheel passenger vehicle
  - STEADY NETWORK**  
4G, Wifi / Hot Spot Support
  - SMALL VOLUME**  
A4 printing support, QR code scanning, sharing email/SMS
  - BIG DATA ANALYSIS**

# TYRE SMART SCANNER

## COME FUNZIONA / HOW TO USE

Scaricare l'App (Leadshub) dall'App Store o dal Play Store e scansionare il codice QR generato dall'App Leadshub.  
*Download the App (Leadshub) from the App Store or Play Store and scan the QR code generated by Leadshub App.*

Premere il tasto "Scansione", scorrere il dispositivo dal lato interno al lato esterno del pneumatico (4 pneumatici)  
*Press scanning button, slide the device from tire inner to outer side (4 tyres)*

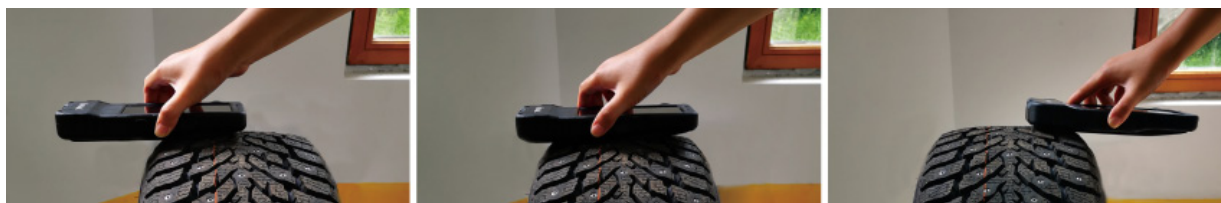

È possibile documentare il difetto del pneumatico rilevato.  
*If the tire defect is detected, it can be documented.*

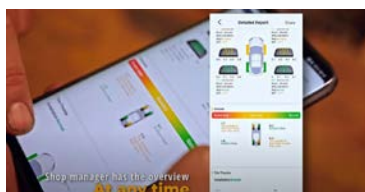

Al termine dell'ispezione, lo schermo del dispositivo passerà automaticamente alla pagina del report  
*After finishing the inspection, device screen will jump to report page automatically*



Scansionare il codice QR per ottenere il report di ispezione digitale. L'utente può consultare i risultati sul PC e stamparli.  
*Scan the QR code in the report to get the digital inspection report. The user can check the report on the PC and print it out.*

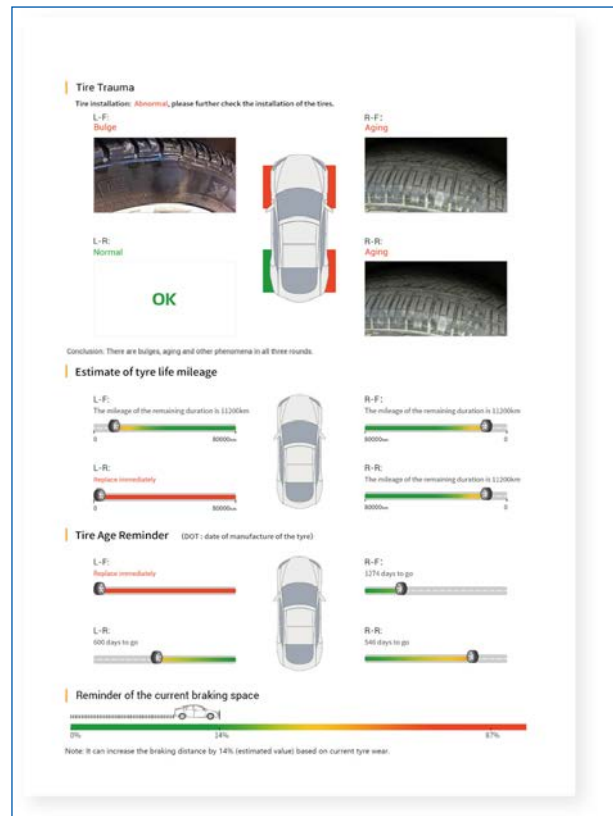
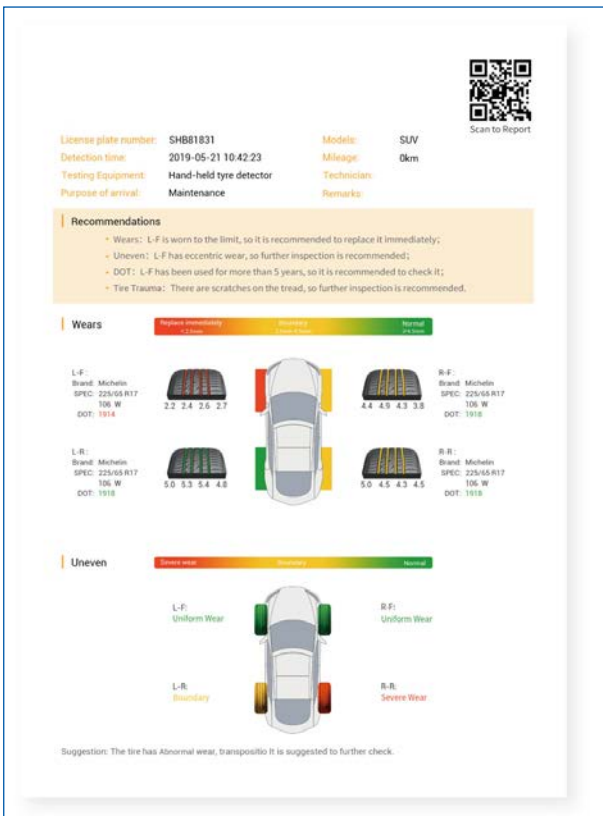

**CARATTERISTICHE TECNICHE:**

- Measurement distance: 0-9.9mm
- Linearity: 0.1mm
- Accuracy: 0.1mm
- Display: 5.45" HD (138mm)
- Optical source: single red laser point
- Battery: 5500mA, Full load=300min
- Material: PC+ABS
- Environment temperature: -10°C~50°C
- Micro-USB, Input: 100-240 V, 50/60Hz; Output: 5V, 1.5A
- Dimensions: 217x82x35mm
- Weight: 415 g

**TECHNICAL FEATURES::**

- Distanza di misurazione: 0-9,9 mm
- Linearità: 0,1 mm
- Precisione: 0,1 mm
- Schermo: 5,45" HD (138 mm)
- Sorgente ottica: singolo punto laser rosso
- Batteria: 5500 mA, carica completa = 300 min
- Materiale: PC+ABS
- Temperatura ambiente: -10°C~50°C
- Micro-USB, Ingresso: 100-240 V, 50/60 Hz;
- Uscita: 5 V, 1,5 A
- Dimensioni: 217x82x35mm
- Peso: 415 grammi



- Misurazione della profondità del battistrada
- Calcolo dell'usura irregolare
- Previsione della distanza di frenata
- Previsione durata rimanente

- 
- Tread Depth Measurement
  - Uneven Wear Calculation
  - Braking Distance Forecast
  - Remaining Lifetime Prediction



Aumenta le vendite di pneumatici e consente ai gommisti di individuare con precisione le opportunità di business  
*Increase sales of tires and empower stores to precisely locate business opportunity*



Migliora il servizio pneumatici e le opportunità di vendita (allineamento e rotazione delle gomme).  
*Increase tire service such as alignment and cross-selling opportunities.*



Migliora la soddisfazione del cliente e crea fiducia tramite un rapporto di ispezione digitale professionale.  
*Enhance customer satisfaction and build trust via professional digital inspection report.*

Cod. 03.001.06

€ 990,00

**NITRO BASIC 3000**



**GENERATORI DI AZOTO PER GONFIAGGIO PNEUMATICI**

di auto e veicoli commerciali (sistema psa)

**NITROGEN GENERATORS**

for car and commercial vehicle tyre inflating (psa system)

**GENERADORES DE NITRÓGENO PARA INFLADO NEUMÁTICO**

de automóviles y vehículos comerciales (sistema psa)

- Pressione max. aria ingresso: 10 bar
- Pressione azoto in uscita: 6-8 bar
- Capacità: 50 lt/min
- Purezza minima: 96%
- Capacità serbatoio: 50lt
- Alimentazione: 220V 50/60Hz
- Max. inlet air pressure: 10 bar
- Outlet nitrogen pressure: 6-8 bar
- Capacity: 50 lt/min
- Min. purity: 96%
- Tank capacity: 50lt
- Power supply: 220V 50/60Hz
- Presión max. de aire en entrada: 10 bar
- Presión de nitrógeno en salida: 6-8 bar
- Capacidad: 50 lt/min
- Pureza mínima: 96%
- Capacidad del tanque: 50lt
- Alimentación: 220V 50/60Hz

**Accessori standard:**

- 2 tubi + pistola per vuoto-gonfiaggio

**Standard accessories:**

- 2 hoses + vacuum-inflating gun

**Accesorios estándar:**

- 2 tubos y generador di vacío

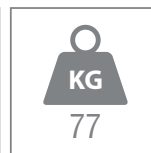
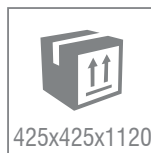

Cod. 03.000.35

€ 10,50

**DISPOSITIVO SMONTAGGIO VALVOLA PNEUMATICI  
CLIP-ON CORE RETRACTING TOOL  
RETRACTOR CLIP-ON**

- Idoneo per portate d'aria fino a 3000lt/min.
- Utilizzabile con gonfiatori analogici o digitali
- Riduce del 50% i tempi di gonfiaggio
- Suitable for an air volume up to 3000lt/min.
- It can be used with digital and analogue inflators
- It reduces by 50% the inflating time
- Suitable for an air volume up to 3000lt/min.
- It can be used with digital and analogue inflators
- It reduces by 50% the inflating time

Cod. 03.000.36

€ 11,40

**COME 03.000.35 CON DISPOSITIVO DI BLOCCAGGIO AUTOMATICO  
AS 03.000.35 WITH AUTOMATIC BLOCKING DEVICE  
COMO 03.000.35 CON UN BLOQUEO AUTOMÁTICO**

FINE SERIE  
SELL OUT



Cod. 03.031.16

€ 109,00

**KIT DI 2 FLANGE Ø 240 MM**

Per sospensioni anteriori di fuoristrada, station wagon

**KIT OF 2 FLANGES Ø 240 MM**

For front-wheel suspensions of all-terrain vehicles and station wagons

**KIT DE 2 BRIDAS Ø 240 MM**

Para suspensiones delanteras de todo terreno y station wagon

- BMW 7ER (E38)
- CHRYSLER
- RENAULT
- GM-X & C
- LANCIA (GAMMA)



Cod. 03.031.01

€ 128,00

**SMONTAMOLLE PER SOSPENSIONI MACPHERSON  
SPRING COMPRESSOR FOR MACPHERSON SUSPENSIONS  
EXTRACTOR DE MUELLES PARA SUSPENSIONES MACPHERSON**



- 1 Ø 110 mm
- 2 Ø 150 mm
- 3 Ø 200 mm

Cod. 03.000.38

€ 337,00



**GONFIATORE ELETTRONICO PER USO INTERNO E ESTERNO ELECTRONIC TYRE INFLATOR FOR INDOOR AND OUTDOOR USE INFLADOR NEUMATICOS DE ALTO FLUJO PARA USO INTERNO Y EXTERNO**

- Pressione max. in entrata **10,5 bar**
- Tubo da 8 mt + valvola di gonfiaggio
- Ideale per: centri servizi rapidi, noleggio auto, concessionari
- Max. inlet pressure **10,5 Bar**
- 8 m hose with clip-on chuck
- Ideal for: Quick Service Centers, Rental Car Facilities and Car Dealers
- Max. presión de entrada **10,5 bar**
- Manguera de 8 m con boquilla con traba
- Ideal para: Centros de servicio rápido, Alquiler de coches

Cod. 03.000.40

€ 425,00



**GONFIATORE ELETTRONICO AD ALTO FLUSSO PER USO INTERNO E ESTERNO HIGH FLOW TYRE INFLATOR FOR INDOOR AND OUTDOOR USE INFLADOR NEUMATICOS DE ALTO FLUJO PARA USO INTERNO Y EXTERNO**

- Pressione max. in entrata **13 Bar**
- Collettore a 4 uscite + 4 tubi da 2 mt con valvole di gonfiaggio di serie
- Può gonfiare fino a 4 pneumatici per volta
- Ideale per: gommisti, autocarri, grandi flotte
- Max. inlet pressure **13 Bar/188 Psi**
- Inflates 1 to 4 tyres simultaneously
- 4 way manifold kit with 4x2m hoses
- Ideal for Tyre Service Centers, Tyre Mounters and Fleet Operations
- Max. presión de entrada **13 bar**
- Infla 1-4 neumáticos simultáneamente
- Kit colector de 4 vías con mangueras de 4x2m
- Ideal para centros de servicio montadores neumáticos y trabajo con las flotas

Cod. 03.000.45

€ 59,00



**PISTOLA DI GONFIAGGIO DIGITALE "HIGH QUALITY" HAND HELD ELECTRONIC INFLATOR "HIGH QUALITY" PISTOLA DE INFLADO DIGITAL "HIGH QUALITY"**

- Corpo in alluminio, copertura in gomma
- Separazione batteria
- Display di ampia dimensione retroilluminato
- Accuratezza  $\pm 0,08$  bar
- Gamma misura 12 bar
- Misura in PSI, BAR, KPA, KGF
- Certificato di taratura incluso
- Aluminum body, gum cover
- Battery separation
- Big backlight display
- Accuracy  $\pm 0,08$  bar
- Measure range 12 bar
- Measure units: PSI, BAR, KPA, KGF
- Calibration certificate included
- Estructura de aluminio, cobertura de goma
- Separación batería
- Amplia pantalla retroiluminada
- Precisión  $\pm 0,08$  bar
- Gama medición 12 bar
- Medición en PSI, BAR, KPA, KGF
- Certificación de calibración incluido



Cod. 05.088.130

€ 176,00



**CARRELLO TRASPORTO GOMME TIPO PESANTE**  
**TRANSPORT TROLLEY FOR HEAVY TYPE TIRES**  
**CARRITO TRANSPORTE DE NEUMÁTICOS PESADOS**

- Facilità d'uso per installare e togliere pneumatici per van e camion
- Rulli rotanti tipo industriale su cuscinetti
- 3 possibilità di regolazione di ampiezza per tipo di pneumatico
- Per pneumatici da 6.5"-22.5"
- Capacità di trasporto: 250 kg
- Dimensioni imballo: 73x33x15 cm, peso: 15 kg

- Easy installation and dismounting of truck wheel assemblies
- Compact design makes one person operation possible
- Three positions for rollers depending on wheel size
- Avoid damage to wheel bolts and expensive modern rims
- For all wheels from 6.5"-22.5"
- Capacity: 250 kg
- Packing dimensions: 73x33x15 cm, weight: 15 kg

- Facilidad de uso para instalar y quitar neumáticos de furgonetas y camiones
- Rodillos giratorios de tipo industrial sobre rodamientos
- 3 posibilidades de ajuste de ancho para cada tipo de neumático
- Para neumáticos de 6.5 "-22.5"
- Capacidad de transporte: 250 kg
- Dimensiones del embalaje: 73x33x15 cm, peso: 15 kg



Cod. 03.000.52

€ 96,00



**TALLONATORE PER PNEUMATICI TUBELESS**  
**BEAD SEATER FOR TUBELESS TYRES**  
**CALZADOR DE TALON PARA NEUMÁTICOS SIN CAMARA**

- Bombola da 19 lt certificata CE
- Valvola di sicurezza CE
- Specifico per uso in tubeless fino a 24.5"
- Manometro Ø 50mm
- Dimensioni imballo: 46x40x31 cm, peso: 14 kg

- CE certified 19 lt tank
- CE certified safety release valve
- Designed for use on tires up to 24.5 "
- Ø 50mm pressure gauge
- Packaging dimensions: 46x40x31 cm, weight: 14 kg

- Cilindro de 19 l con certificado CE
- Válvula de seguridad CE
- Especifico para uso sin cámara de hasta 24,5 "
- Manómetro Ø 50 mm
- Dimensiones del embalaje: 46x40x31 cm, peso: 14 kg

Cod. 05.088.94

€ 56,00

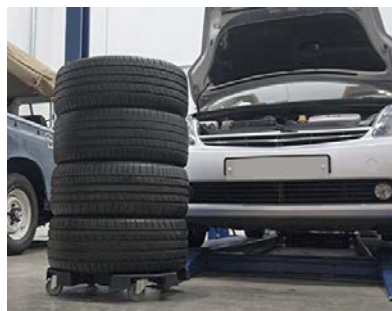

**CARRELLO PORTA GOMME**  
**TYRE TRANSPORT DOLLY**  
**CARRO DE TRANSPORTE PARA NEUMÁTICOS**

- ø max 620 mm
- Portata: 150 kgs
- Ruote sovrapponibili
- con 4 impugnature per trasporto
- 2 ruote con freno
- Miusra imballo: 64x64x17,5cm
- Peso: 4,2 kg

- ø max 620 mm
- Capacity: 150kgs
- Stackable wheels
- With 4 handles for transport
- 2 wheels with brake
- Packaging size: 64x64x17,5cm
- Weight: 4,2 kg

- ø max 620 mm
- Capacidad: 150kgs
- Ruedas apilables
- Con 4 mangos para el transporte
- 2 ruedas con freno
- Tamaño de embalaje: 64x64x17,5cm
- Peso: 4,2 kg

Cod. 03.000.47

€ 9,90

**MISURATORE DIGITALE DI PROFONDITÀ BATTISTRADA**  
**DIGITAL TREAD DEPTH GAUGE**



Campo di misura/range: 0-1 "0-25.4mm/0-11/16"

Cod. 05.088.58

€ 175,00

Ø  
max 800  
mm



**TYRES' TRANSPORT TROLLEY**  
**CARRO DE TRANSPORTE NEUMÁTICOS**  
**CARRELLO TRASPORTO PNEUMATICI**

- Materiale: Acciaio
- Portata: 150 kg
- Dimensioni imballaggio: 930x220x570mm, peso: 21kg
- Ruote: 2x Ø 260mm, 2x Ø 125mm
- Diametro massimo ruota trasportabile: 800mm

- Material Steel
- Capacity: 150 kg
- Packing dimensiones: 930x220x570mm, weight: 21kg
- Wheels: 2x Ø 260mm, 2x Ø 125mm
- Maximum diameter transportable wheel: 800mm

- Material: acero
- Capacidad: 150 kg
- Dimensions embalaje: 930x220x570mm, weight: 21kg
- Ruedas: 2x Ø 260mm, 2x Ø 125mm
- Diámetro máximo rueda transportable: 800mm



Ø  
max 1800  
mm



Cod. 05.084.11L

€ 850,00

**SOLLEVATORE MECCANICO PER**  
**RUOTE DI VEICOLI COMMERCIALI,**  
**INDUSTRIALI, MACCHINE**  
**AGRICOLE**

- Diametro max pneumatico: 1800mm
- Altezza di sollevamento: 0-770mm
- Capacità: 1200kgs
- Dimensioni macchina montata: 1270x990x1340mm
- Peso netto/lordo: 106/121kgs
- Dimensioni imballo: 1398x448x368mm
- Smontabile

**MECHANIC LIFT FOR WHEELS**  
**OF COMMERCIAL, INDUSTRIAL**  
**VEHICLES AND AGRICULTURAL**  
**MACHINERY**

- Max tyre diameter: 1800mm
- Lifting height: 0-770mm
- Capacity: 1200kgs
- Assembled machine size: 1270x990x1340mm
- Net/gross weight: 106/121kgs
- Package dimensions: 1398x448x368mm
- Dismountable

**GATO MECÁNICO PARA RUEDAS**  
**DE VEHÍCULOS COMERCIALES,**  
**INDUSTRIALES Y MÁQUINAS**  
**AGRÍCOLAS**

- Max diámetro neumático: 1800mm
- Altura de elevación: 0-770mm
- Capacidad: 1200kgs
- Tamaño máquina montada: 1270x990x1340mm
- Peso neto/bruto: 106/121kgs
- Dimensiones del embalaje: 1398x448x368mm
- Desmont

**GABBIE DI SICUREZZA PER GONFIAGGIO PNEUMATICI**  
**SAFETY CAGES FOR TIRE INFLATION**  
**JAULAS DE SEGURIDAD PARA INFLAR NEUMÁTICOS**



> Il colore del prodotto in foto è indicativo  
 > The color of the product in the picture is indicative  
 > El color del producto en la imagen es indicativo

**2 MODELLI DISPONIBILI:**

- **BASIC** fino a pneumatici di 22.5"
- **HD** in robusto tubolare di acciaio

- Sono dotate di una rete a maglie strette in grado di fermare frammenti di gomma o di cerchioni in caso di accidenti.
- Costruita in accordo con direttiva EU 2006/WE – si rilascia una dichiarazioni di conformità per ciascun modello.
- Le gabbie di gonfiaggio per veicoli industriali sono previste dalla **normativa C.U.N.A. NC 195-09 e UNI 10558:2005**.
- Il mancato utilizzo di questi dispositivi di sicurezza, in caso di infortunio grave o morte dell'operatore, comporta la responsabilità del datore di lavoro.
- **Il modello BASIC** è destinato soprattutto a imprese di autotrasporto, che svolgono al loro interno la manutenzione dei pneumatici delle trattrici e dei rimorchi.
- **Il modello HD** è destinato per gommisti professionali in conto terzi. Entrambe le gabbie possono essere equipaggiate con i gonfiatori elettronici (mono tubo) cod. 03.000.38 (per modello BASIC) o con pistole di gonfiaggio manuali con tubo di lunghezza adeguata (almeno 2 mt)

**2 MODELS AVAILABLE**

- **BASIC** up to 22.5" tires
- **HD** in sturdy steel tubular

- Equipped with a tightly meshed net capable of stopping rubber fragments or rims in case of accidents.
- Built in accordance with EU directive 2006 / WE - a declaration of conformity is issued for each model.
- The inflation cages for industrial vehicles are laid down in the **C.U.N.A. NC 195-09 and UNI 10558: 2005 regulations**.
- Failure to use these safety devices, in the event of serious injury or death of the operator, entails the responsibility of the employer.
- The **BASIC model** is mainly intended for road haulage companies, which carry out the maintenance of tractor and trailers' tires internally.
- The **HD model** is intended for professional tire specialists on behalf of third parties. Both cages can be equipped with electronic inflators (single tube) cod. 03.000.38 (for BASIC model) or with manual inflation guns with a hose of suitable length (at least 2 meters)

**Cod. 03.000.50**

**€ 2.590,00**

**BASIC**

- Pressione max/max operating pressure: 10 bar
- Tubo interno con valvola di gonfiaggio inclusi
- External dim: 133x75x133 cm
- Internal dim: 119x53x119,5
- Peso/weight: 160 kg

**Cod. 03.000.51**

**€ 2.990,00**

**HD**

- Pressione max/max operating pressure: 10 bar
- Internal hose with inflation valve included
- External dim: 155x85x150 cm
- Internal dim: 138x64x139 cm
- Peso/weight: 210 kg

**2 MODELOS DISPONIBLES**

- **BÁSICO** para neumáticos de 22,5"
- **HD** en tubular de acero robusto

- Están equipados con una red de malla apretada capaz de detener fragmentos de goma o llantas en caso de accidentes.
- Fabricado de acuerdo con la directiva de la UE 2006 / WE: se emite una declaración de conformidad para cada modelo.
- Las jaulas de inflado para vehículos industriales son proporcionadas por la **C.U.N.A. NC 195-09 y UNI 10558: 2005**.
- La falta de uso de estos dispositivos de seguridad, en caso de lesiones graves o muerte del operador, implica la responsabilidad del empleador.
- El **modelo BASIC** está destinado principalmente a empresas de transporte por carretera, que realizan el mantenimiento de los neumáticos de tractores y remolques de forma interna.
- El **modelo HD** está destinado a especialistas profesionales en neumáticos para terceros. Ambas jaulas pueden equiparse con infladores electrónicos (monotubo) cod. 03.000.38 (para modelo BASIC) o con pistolas de inflado manual con manguera de longitud adecuada (al menos 2 mt)

Cod. 05.091.12

€ 399,00



**3/4" AVVITATORE AD IMPULSI**  
in materiale composito a DOPPIO battente

**3/4" IMPACT WRENCH**  
in composite material with DOUBLE hammer

**3/4" LLAVE DE IMPACTO**  
en material compuesto con percutor DOBLE

3/4"

COPPIA DI SERRAGGIO MAX  
MAX. WORKING TORQUE  
TORSIÓN DE APRIETE MAX  
**2.092 Nm**

DOPPIO BATTENTE

TWIN HAMMER

209 MM

3 KG

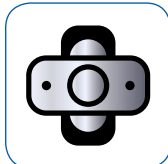

6000 RPM

2.092 MM



**6,2 Bar max**

Cod. 05.091.12.R1

€ 30,00

Kit riparazione  
Repair kit  
Kit de reparación



Cod. 05.091.05DP

€ 171,00



**1/2" AVVITATORE AD IMPULSI**  
in materiale composito a DOPPIO battente

**1/2" IMPACT WRENCH**  
in composite material with DOUBLE hammer

**1/2" LLAVE DE IMPACTO**  
en material compuesto con percutor DOBLE

1/2"

COPPIA DI SERRAGGIO MAX  
MAX. WORKING TORQUE  
TORSIÓN DE APRIETE MAX  
**1.283 Nm**

DOPPIO BATTENTE

TWIN HAMMER

179 MM

1,6 KG

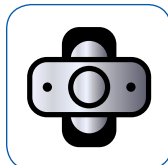

8500 RPM

1.283 NM



**6,2 Bar max**

Cod. 05.091.05DP.R1

€ 30,00

Kit riparazione  
Repair kit  
Kit de reparación



Cod. 05.091.04DP

€ 148,00

NEW!

1/2" AVVITATORE NANO AD IMPULSI  
in materiale composito a DOPPIO battente

1/2" MINI IMPACT WRENCH  
in composite material with DOUBLE hammer

1/2" MINI LLAVE DE IMPACTO  
en material compuesto con percutor DOBLE

1/2"

COPPIA DI SERRAGGIO MAX  
MAX. WORKING TORQUE  
TORSIÓN DE APRIETE MAX  
610 Nm



DOPPIO BATTENTE

TWIN HAMMER

125 MM

1,25 KG

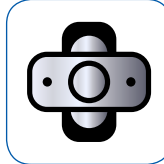

10000 RPM

610 MM



6,2 Bar  
max

Cod. 05.091.04DPR1

€ 30,00

Kit riparazione  
Repair kit  
Kit de reparación



Cod. 05.091.11

€ 135,00

1/2" AVVITATORE ANGOLARE AD IMPULSI

1/2" RIGHT ANGLE IMPACT WRENCH

1/2" LLAVE DE IMPACTO ANGULAR

1/2"

COPPIA DI SERRAGGIO MAX  
MAX. WORKING TORQUE  
TORSIÓN DE APRIETE MAX  
500 Nm



MONOBATTENTE

JUMBO HAMMER

7500 RPM

1,42 KG

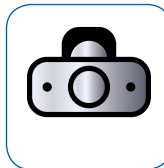

88 MM

248 MM

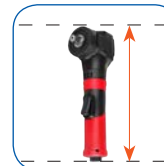

6,2 Bar  
max



AVVITATORI CON SISTEMA DI RAFFREDDAMENTO AD ARIA

Il sistema di raffreddamento ad aria mantiene gli avvitatori sempre a bassa temperatura

IMPACT WRENCH WITH AIR COOLING SYSTEM

Air cooling system keeps tools in low temperature all the time

BUDGET

Cod. 05.091.13

€ 110,00



1/2" AVVITATORE AD IMPULSI

con sistema di raffreddamento ad aria

1/2" IMPACT WRENCH

with air cooling system

1/2" LLAVE DE IMPACTO

con sistema de refrigeración por aire

1/2"

COPIA DI SERRAGGIO MAX  
MAX. WORKING TORQUE  
TORSIÓN DE APRIETE MAX

2.230 Nm



DOPPIO BATTENTE

TWIN HAMMER

185 MM

2,2 KG

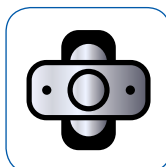

7.500 RPM

2.230 NM



6,2 Bar  
max

Air Flow  
184 lt/1

Cod. 05.091.14

€ 82,00



1/2" AVVITATORE AD IMPULSI

con sistema di raffreddamento ad aria

1/2" IMPACT WRENCH

with air cooling system

1/2" LLAVE DE IMPACTO

con sistema de refrigeración por aire

1/2"

COPIA DI SERRAGGIO MAX  
MAX. WORKING TORQUE  
TORSIÓN DE APRIETE MAX

1.200 Nm



DOPPIO BATTENTE

TWIN HAMMER

120 MM

1,2 KG

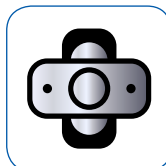

9.000 RPM

1.200 NM



6,2 Bar  
max

Air Flow  
170 lt/1

**ACCESSORI PER AVVITATORI A IMPATTO**  
**ACCESSORIES FOR IMPACT WRENCHES**  
**ACCESORIOS PARA LLAVES DE IMPACTO**

**Cod. 05.090.58 € 30,00**



**5pcs 1/2" Drive Impact Socket Set**  
The 6pt sockets are externally sleeved to prevent damage to alloy wheels.  
Color coding for ease of size selection.  
Size: 15, 17, 19, 21, 22mm

**Bussole smontaggio bulloni 1/2", 5pz**  
Le bussole da 6pt sono dotate di manica per prevenire danni ai cerchi in lega.  
I colori permettono un facile riconoscimento delle misure.  
Misure: 15, 17, 19, 21, 22mm

**Juego de 5pcs de dados de impacto 1/2"**  
Los dados de 6pt tienen una manga externa para evitar daños en las llantas de aleación.  
Codificación de colores para facilitar la selección de las dimensiones:  
15, 17, 19, 21, 22mm

**Cod. 05.090.61 € 34,00**

CR-MO



Set bussole 1/2" 10 pz  
EXTRA CORTE per chiave a impulso 10-24mm  
Prolunga 150mm  
Giunto girevole

1/2" 10pcs kit of impact sockets  
EXTRA SHORT for impact wrench 10-24mm  
Extension bar 150mm  
Universal joint

Juego de 10pcs de dados 1/2" de impacto para llave de impacto 10-24mm  
Barra de extension de 150mm  
Junta universal

**Cod. 05.090.54 € 30,90**

CR-MO



12.5 1/2"

Kit 9pz 1/2" inserti bussole  
9pcs 1/2" Drive Impact Bits Socket  
Juego de 9pcs 1/2" insertos dados  
Taglie/ Sizes/ Tallas:  
4, 5, 6, 8, 9, 10, 12, 14, 16 mm

**Cod. 05.090.56 € 30,90**

CR-MO



12.5 1/2"

Kit 9pz 1/2" inserti bussole  
9pcs 1/2" Impact Sockets Set  
Juego de 9pcs 1/2" insertos dados  
Taglie/ Sizes/ Tallas:  
T20, T25, T30, T40, T45, T50, T55, T60, T70

**Cod. 05.090.88 € 8,00**



Bussola per smontaggio bullone antifurto, con profilo Toyota / Hyundai / Kia  
Socket for removing anti-theft bolt with Toyota / Hyundai / Kia profile  
Junta de extracción perno antirrobo con contorno Toyota / Hyundai / Kia

**Cod. 05.090.66 € 7,00**

MERCEDES



Ø17 L = 80mm

Bussola per smontaggio bullone antifurto, con profilo Mercedes  
Socket for removing anti-theft bolt with Mercedes profile  
Junta de extracción perno antirrobo con contorno Mercedes  
Idonea per i modelli:  
Suitable for the models:  
Compatible con los modelos:

C&GLK	W204
E	W211, W212, W207
SLK	W172
CL	W216
S	W221, W222

**Cod. 05.090.24 € 15,00**



Supporto magnetico per avvitatore ad aria e bussole  
2-magnets holder for air impact wrench and sockets  
Soporte de 2 magnetos para llaves de impacto y brujulas

**Cod. 05.090.55 € 30,90**

CR-MO



12.5 1/2"

Kit 9pz 1/2" inserti bussole  
9pcs 1/2" Drive Impact Bits Socket  
Juego de 9pcs 1/2" insertos dados  
Taglie/ Sizes/ Tallas:  
5, 6, 7, 8, 9, 10, 12, 13, 14 mm

**Cod. 05.090.57 € 30,90**

CR-MO



12.5 1/2"

Kit 8pz 1/2" inserti bussole esagonali  
8pcs 1/2" Drive Impact Hex Bits Socket  
Juego de 8 pcs 1/2" insertos dados hexagonales  
Taglie/ Sizes/ Tallas:  
5, 6, 8, 10, 12, 14, 17, 19mm

SET BUSSOLE RIMOZIONE DADI ANTIFURTO  
SET OF SOCKETS FOR REMOVING ANTI-THEFT BOLTS  
JUNTAS DE EXTRACCIÓN PERNOS ANTIRROBO

SET DI 7 CASSETTE: SCONTO EXTRA 15%  
7 SETS: 15% EXTRA DISCOUNT  
JUEGO DE 7 CASSETES: DESCUENTO ADICIONAL 15%

**ATTENZIONE! NON UTILIZZARE AVVITATORI A PERCUSSIONE con questi kit bussole rimozione dadi antifurto!**

**WARNING! DO NOT USE IMPACT WRENCH for these sets of sockets for removing anti-theft bolts!**

**ATENCIÓN! NO SE PUEDEN UTILIZAR LLAVES DE IMPACTO a percusión con estos juntas de extracción pernos antirrobo!**

Cod. 05.090.67 € **112,00**



Set 20 chiavi a bussola per rimozione dadi antifurto BMW  
20 pcs anti theft wheel nut remover for BMW  
20 llaves de vaso para tornillos antirrobo de ruedas BMW

OEM 36-2-010

Cod. 05.090.68 € **67,00**



Set 20 chiavi a bussola per rimozione dadi antifurto PORSCHE  
20 pcs anti theft wheel nut remover for PORSCHE  
20 llaves de vaso para tornillos antirrobo de ruedas PORSCHE

OEM T10190

Cod. 05.090.78 € **69,00**



Set 23 chiavi a bussola per rimozione dadi antifurto VW  
23 pcs anti theft wheel nut remover for VW  
23 llaves de vaso para tornillos antirrobo de ruedas VW

OEM T-101-01 / T40004

Cod. 05.090.77 € **65,00**



Set 21 chiavi a bussola per rimozione dadi antifurto BMW  
21 pcs anti theft wheel nut remover for BMW  
21 llaves de vaso para tornillos antirrobo de ruedas BMW

OEM 36-1-335

Cod. 05.090.80 € **123,00**



Set 20 chiavi a bussola per rimozione dadi antifurto AUDI  
20 pcs anti theft wheel nut remover for AUDI  
20 llaves de vaso para tornillos antirrobo de ruedas AUDI

OEM T40073

Cod. 05.090.79 € **121,00**



Set 20 chiavi a bussola per rimozione dadi antifurto VW  
20 pcs anti theft wheel nut remover for VW  
20 llaves de vaso para tornillos antirrobo de ruedas VW

OEM T10133

Cod. 05.090.81 € **158,00**



Set 35 chiavi a bussola per rimozione dadi antifurto MERCEDES  
35 pcs anti theft wheel nut remover for MERCEDES  
35 llaves de vaso para tornillos antirrobo de ruedas MERCEDES

OEM 301-332

PROMO 2022/2





Cod. 05.098.01

€ 34,00

**SERIE BUSSOLE SMONTAGGIO TAPPI OLIO MOTORE e pulegge distribuzione**

**1/2" 18 PCS OIL-CHANGE AND DISTRIBUTION pulley socket set**

**JUEGO DE 18 PIEZAS 1/2" DE LLAVES para tapones aceite motor y poleas de distribución**

Nuovo modello con cricco 3/8" e bussole quadre da:  
New model with 3/8" ratchet and  
Nuevo modelo con trinquete 3/8" y llaves de tubo cuadradas

5/16, 3/8, 7, 8, 10, 11,  
12, 13, hasta 14 mm.

Chiavi esagonali da:  
square sockets: 8, 9, 10, 11, 12, hasta 14 mm.  
Llaves hexagonales:

Triangolari:  
Triangular: 10mm  
Triangular:

Quadra incassata:  
Square socket: 10mm  
Llave de tubo:

Cod. 05.062.02

€ 13,20



Pinza per rimozione supporti in gomma per tubazioni di scarico, utilizzabile per una vasta gamma di auto e veicoli commerciali

Pliers for removing rubber supports of exhaust gas systems, suitable for a wide range of cars and commercial vehicles

Alicates para la eliminación de soportes de goma para tuberías de gas de escape, utilizables para una amplia gama de coches y vehículos comerciales

Cod. 02.022.91

€ 15,40



**PINZA DISTACCO RACCORDI RAPIDI per tubi olio-benzina**

**PLIERS FOR DETACHMENT OF QUICK FITTINGS for oil and petrol hoses**

**PINZA PARA SEPARACIÓN DE CONEXIONES RÁPIDAS para mangueras de aceite y gasolina**

Cod. 05.062.00

€ 70,00



**KIT DI 7 PINZE SMONTAGGIO FASCETTE PER TUBI  
KIT OF 7 HOSE CLAMP PLIERS  
KIT DE 7 ALICATES PARA DESMONTAR ABRAZADERAS TUBOS**



Cod. 05.062.00.R1

€ 21,00

360°

nuova testina rotante

A



Cod. 03.036.04

€ 15,00

Tanica scarica olio esausto (15lt)  
Temperatura di lavoro -30°/+80°C  
Comode maniglie anteriore e posteriore  
Sufficiente per tutte le applicazioni

Tank to discharge exhaust oil (15lt)  
Working temperature -30°/+80°C  
Comfortable front and rear handles  
Capacity enough for all the applications

Tanque para la descarga de aceite usado (15lt)  
Temperatura de funcionamiento -30°/+80°C  
Cómodas asas, delantera y posterior  
Suficiente para todas las aplicaciones

SPURGAFRENI ELETTRICO  
ELECTRIC BRAKE BLEEDER

NEW!

Cod. 03.036.35

€ 770,00

BRAKE MATE MK2



MADE IN ITALY

CARATTERISTICHE TECNICHE

- 2 pompe: una per il recupero del liquido usato e una per l'inserimento del liquido nuovo
- Portata pompa: 1 lt/min
- Liquidi compatibili: Pre DOT - DOT2 - DOT3 - DOT4 - DOT5 - DOT5.1 - DOT6 - DOT6.1 - LHM
- Pressione di esercizio: 0 - 4 bar
- Lunghezza tubo mandata: 7.5 m
- Lunghezza tubo aspirazione: 7.5 m
- La carrozzeria è dotata di apposito vano per riporre il corredo (A)
- 5 adattatori di varie dimensioni (B)
- Spazio per la cassetta dei nuovi tappi a richiesta cod. 03.036.28 (C)
- Spazio per taniche fino a 25 lt (D)
- Tanica da 5 lt per fluido nuovo (E)
- Tanica da 5 lt per fluido esausto (F)
- Lunghezza cavo alimentazione: 3 m
- Alimentazione: 230V 50-60 Hz
- Dimensioni: 67x54x90H cm
- Peso: 35 Kg

TECHNICAL FEATURES

- 2 pumps: one for the waste liquid recovery and one for the insertion of the new liquid
- Pump capacity: 1 lt/min
- Compatible liquids: Pre DOT - DOT2 - DOT3 - DOT4 - DOT5 - DOT5.1 - DOT6 - DOT6.1 - LHM
- Operating pressure: 0 - 4 bar
- Delivery hose length: 7.5 m
- Suction hose length: 7.5 m
- The cabinet is equipped with a special compartment for storing the accessories (A)
- 5 adapters of various sizes (B)
- Space for the optional box with new caps, cod. 03.036.28 (C)
- Space for optional tank up to 25 lt (D)
- 5 lt tank for the new fluid (E)
- 5 lt tank for the waste liquid (F)
- Power supply cable length: 3 m
- Power supply: 230V 50-60 Hz
- Dimensions: 67x54x90 cm
- Weight: 35 Kg

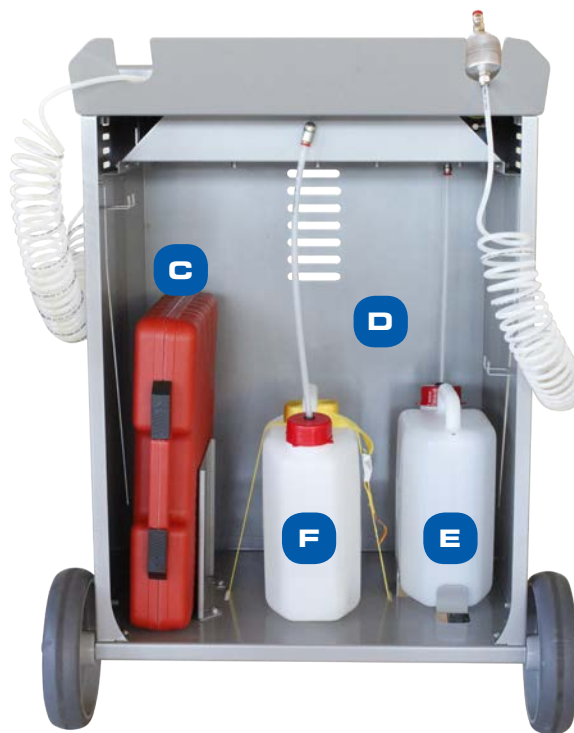

Cod. 05.036.04

€ 249,00

- Alimentazione: 12V DC da batteria
- Range di misurazione: 0-320 °C
- Display a colori TFT
- Software semplice e affidabile per differenti tipi di fluido per i freni (DOT3, DOT4, SUPER DOT4, DOT5, DOT5.1).



**NUOVO TESTER LIQUIDO FRENI CON RISCALDATORE  
NEW BRAKE FLUID BOILING POINT TESTER 12V DC**

- Power supply: 12V DC from battery
- Measuring range: 0-320 °C
- TFT color display
- Simple and reliable software for different types of brake fluid (DOT3, DOT4, SUPER DOT4, DOT5, DOT5).



Cod. 03.036.28

€ 148,00

NEW!

**KIT TAPPI PER SPURGOFRENI  
MASTER CYLINDER ADAPTER KIT  
JUEGO DE TAPONES PARA SANGRADORES DE FRENO**

- adatto per la maggior parte degli spurgo freni a pressione
- adattatore per tappi europei, tappi multiveicolo, tappo americano (GM), BMW/Audi, Nissan, Mazda e Honda
- adattatori universali e tappi di produttori specifici
- gli adattatori son compatibili col 90% dei serbatoi attuali del cilindro maestro
- suitable for most pressure brake bleeders
- European cap adapter, multi vehicle caps, American adapter (gm), BMW/Audi, Nissan, Mazda & Honda
- universal adapters and manufacturer specific caps
- adapters fit 90% of current master cylinder reservoirs
- adecuado para la mayoría de los sangradores de freno de presión
- Adaptador para tapon europeo, tapones multi-vehículo, tapon americano (GM), BMW/Audi, Nissan, Mazda y Honda
- adaptadores universales y tapones específicos del fabricante
- los adaptadores caben el 90% de los depósitos actuales de los cilindros maestros



Cod. 03.036.39

€ 43,00

NEW!

- Kit for Toyota



Cod. 03.036.40

€ 43,00

NEW!

- Kit for Toyota Hino





Cod. 05.019.03

€ 130,00

**PROVA RADIATORI E RIEMPIMENTO RADIATORI SOTTOVUOTO (26PZ)**  
**COOLING SYSTEM ANALYZER AND RADIATORS FILL VACUUM (26PCS)**  
**PROBADOR DE RADIADORES Y LLENADOR DE RADIADORES BAJO VACÍO (26UDS)**

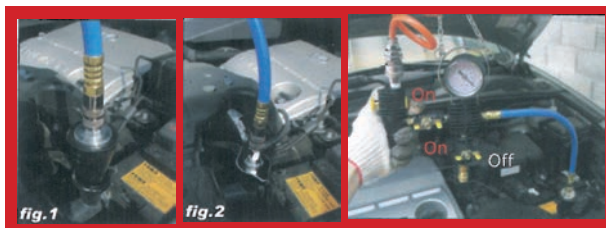

Cod. 05.090.72

€ 119,00

**KIT DI 36 UTENSILI PER ESTRAZIONE E INTRODUZIONE**  
*silent blocks, paraoli e cuscinetti*  
*attrezzatura universale per settore auto e camion*

**KIT OF 36 TOOLS FOR THE EXTRACTION AND INSERTION**  
*of silent-blocks, oil blocks and bearings*  
*universal equipment for the vehicles' and trucks' industry*

**KIT DE 36 HERRAMIENTAS PARA LA EXTRACCIÓN E INSERCIÓN**  
*de silent-blocks, bloques aceite y cojinetes*  
*Equipo universal para el sector de los camiones y vehículos*

Il kit contiene:

4 barre filettate  
(M10, M12, M14, M16) e  
20 boccole per: interni  
Ø (34, 36, 38, 70, 72mm)  
ed esterni  
Ø (44,46, 48, 80, 82mm)

The kit includes:

4 threaded bars  
(M10, M12, M14, M16),  
20 bushings for:  
internal Ø (34, 36, 38, 70,72mm)  
and external  
Ø (44, 46, 48, 80, 82mm)

El kit incluye:

4 barras roscadas  
(M10, M12, M14, M16),  
20 bushings para: diámetros  
internos (34, 36, 38, 70, 72 mm)  
y externos (44, 46, 48, 80, 82 mm)

Cod. 05.056.12

€ 41,00



**CHIAVE REGOLABILE PER**  
**SMONTAGGIO**  
**GHIERE GALLEGGIANTI**  
**RANGE: 89-170MM**

Utilizzabile sia all'interno che  
all'esterno della ghiera

**ADJUSTABLE WRENCH FOR REMOVING FLOATS'**  
**FERRULES RANGE: 89-170 MM**

It can be used both inside and outside the ring

**LLAVE AJUSTABLE PARA QUITAR CABEZAS**  
**DE RANGO: 89-170MM**

Se puede utilizar tanto dentro como fuera de la cabeza

Cod. 05.056.08

€ 9,90



**CHIAVE SMONTAGGIO FILTRO GASOLIO (MOTORI HDI)**

**FUEL FILTER SOCKET (HDI ENGINES)**

Specialist socket required for the removal of diesel fuel filter  
fit for HDI engines

**LLAVE PARA FILTRO DE COMBUSTIBLE (MOTORES HDI)**

Llave para especialistas requerida para la remoción del  
filtro de combustible diesel para motores HDI



• **Modelli / Models / Modelos:**

- C4 2.0 HDi 16v, C4 Picasso 2.0/2.2 HDi, C5, C8 2.0/2.2 HDi 16v, Jumpy 2.0/ 2.2 HDi;
- Fiat Scudo, Ulysse Mk II 2.0 JTD 16v;
- Ford Focus/ Focus C-Max Galaxy/ Kuga S-Max 2.0 TDCi;
- Peugeot 307/ 308/ 407/ 607 807/ Expert 2.0 HDi 16v;
- Volvo C30/ C70/ S40 Mk II, V50 2.0 Diesel (136 HP).



Cod. 05.058.01

€ 86,60

**NUOVO KIT REGISTRO PISTONCINI FRENI**  
con pistone pneumatico

**NEW BRAKE CALIPER TOOL KIT**  
with pneumatic piston

**NUOVO CALIBRADOR NEUMÁTICO DE FRENOS**  
con pistón neumáticos

Il pistone pneumatico mantiene la pressione sul cilindretto che può essere facilmente ruotato verso destra o verso sinistra dalla leva.

The pneumatic piston maintains the pressure on the cylinder that can be easily turned right or left by using a lever.

El pistón neumático presiona el cilindro que se puede girar a la derecha o a la izquierda utilizando la palanca.

Cod. 05.058.07

€ 26,95



**AGGIORNAMENTO AL KIT**  
**UPGRADE FOR KIT**  
**ACTUALIZACIÓN PARA KIT**  
**05.058.01**

APPLICAZIONI / APPLICATIONS / APLICACIONES

B1 Ford	B4 BMW	W Passat VW
B3 BMW	B5 Mini/BMW	B2 Iveco Daily

Cod. 05.058.09

€ 25,20

**SET 3PCS ARRETRATORI PISTONCINI**  
**KIT OF 3 PCS OF SMALL PISTONS' PULLERS**  
**KIT DE 3 PIEZAS DE EXTRACTORES PARA PISTONES PEQUEÑOS**



Aggiornamento al kit - Upgrade for kit - Actualización para kit 05.058.01

Cod. 05.058.08

€ 10,50



**KIT RIMOZIONE**  
**PINZE FRENO, 3PZ**

**BRAKE CALIPERS'**  
**DISMANTLING KIT, 3PCS**

**KIT DE DESMONTAJE**  
**PINZAS DE FRENO, 3 UN.**

Il kit include:  
Chiave pentagonale da 14mm per Opel Zafira, Astra, Smart  
Chiave pentagonale da 19mm per pinze Bendix (Citroen, Peugeot, Renault)  
Chiave pentagonale da 10mm per pinze Girling

The kit includes:  
14mm pentagonal socket wrench for Opel Zafira, Astra, Smart  
19mm pentagonal socket wrench for Bendix calipers (Citroen, Peugeot, Renault)  
10 mm male pentagonal socket wrench for Girling calipers

El kit incluye:  
Llave pentagonal de 14mm para Opel Zafira, Astra, Smart  
Llave pentagonal de 19mm para pinzas Bendix (Citroen, Peugeot, Renault)  
Llave pentagonal de 10mm para pinzas Girling

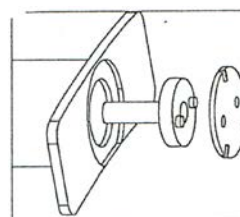

Il kit include/the kit includes/el kit incluye:

- A) VW, Audi A4-5-6-8, VW Passat, Tiguan 2007
- B) BMW, Mini, Smart, VW
- C) Nissan - Opel - Toyota

Cod. 05.056.20

€ 3,90

**CHIAVE UNIVERSALE PER FILTRI OLIO/GASOLIO**  
regolabile 50-100mm diametro

**OIL FILTER STRAP WRENCH**  
adjustable 50-100mm diameter



Cod. 05.056.07

€ 64,<sup>00</sup>

**SET DI CHIAVI SMONTAGGIO FILTRI OLIO PER AUTO E FURGONI**  
**OIL FILTERS CUPS KITS FOR CARS-VANS**  
**SET DE LLAVES PARA FILTROS ACEITE COCHES-CAMIONETAS**



Cod. 05.056.03

€ 19,<sup>00</sup>

**Mercedes, Smart, VW, Opel, BMW**  
 (24/27/32/36/38mm)

FINE SERIE  
 SELL OUT



66mm/6P	Fiat Punto, 1 2) Renault (Clio 1 2 Express, Kangoo Twingo) etc	86mm/16P	Volvo (S40.S60.S70.S80) etc
65mm/14P	Champ. Hastings GnVAc. wix, Napa, Purolator, Daihatsu, Toyota, Nissan etc	86mm/18P	VW Golf (MKIII Tdi, passat Tdi.) Audi A6 Tdi, Renault (Clio Rapid 19D Laguna Safrane Espace 21D) Citroen, Peugeot, Renault, etc
65~67mm/14P	Fits same filters as made in Canada including PH4386 PH4967 PH6017 PH6018 Daihatsu etc.	90mm/15P	Fits Honda Accord Mitsubishi Mopar Isuzu
68mm/14P	Hastings, Mazda, Ford Escor, Capri, Subaru, Fran PH6607 (tram filters made in Korea), Motorcraft FLS16	92mm/10P	Fiat Cinquecento, Coupe, Croma. Fiat. Panda Regata Ritmo Fiat. Seicento Tempra. Tipo. Lancia (Beta Deda Kappa Monte Carlo Prisma Thema Trevi) etc
73mm/14P	Toyota / Lexus, etc	93mm/15P	Casite, Champ. Champion, GM Fram. Hastings Opel, Mazda, Volvo, Mitsubishi Purolator. Wix, Nissan, VW, Porsche. Renault Ford, Honda, Audi etc
74mm/15P	MF. Audi, #056-115-561g, GM. Rover. Chrysler, etc.	93mm/36P	Fits Motorcraft only-FL1A, FLA1B. FL300. FL820. Ford, etc
74~76mm/15P	Fits Fram, Ac. Saturnm. etc	93mm/45P	VW-Audi (Tdi2 4.2 6,2 8L) etc
75~77mm/15P	VW, Audi Casite, GM/AC, Hastings, Wix. NAPA, Ford, Isuzu, Mercedes, Opel, etc.	95mm/15P	Toyota #15600-41010 Alfa. GM, Ford. ALFA, Chrysler, etc
76mm/12P	Fiat (Ducato. Scuro. Ulysee), Renault. (Megane Laguna Espace III) etc	96mm/18P	Audi (A4A6Tdi). VW (Passat 97Tdi) Renault (Laguna 2.2d Safrane 2.2D.) Espace 2.2DR19. RAPID. MEGANE. 19/21D TDi) etc
76mm/14P	Champion, Champ Lee, Purolator, Mopar. VW, Porsche, Mercedes Benz, BMW, Audi. (I. B. A3TD) Opel etc.	100mm/15P	Fits fram, Motorcraft. wix, Isuzu and Mitsubishi, etc
76mm/30P	Fits Motorcraft only-FL400A. Ford etc	106mm/15P	Fiat (Ducato 2 5D Td) etc
76mm/8P	Fiat (Marea), Lancia (Delta) etc.	108mm/15P	Volvo (C70.S70.V70. Tdi TD) (Turbo. Diesel 850 Tdi Diesel) etc
78mm/15P	Nissan #15208H8991. Ford, Toyota, Accord etc	108mm/18P	Renault (Espace, Laguna. Master, Safrane, Traffic 2.4, 2.5, 2.8D, TD) etc
80mm/15P	Hastings Fram, Purolator, Nissan, Honda. Motorcraft, Mazda, Isuzu, Subaru. Opel. Toyota, etc	A2089	
80~82mm/15P	Wix filters branded for Mazda, Subaru, Toyota, Honda, Acura Nissan, NAPA etc.	Adapter	

Cod. 05.056.09

€ 48,<sup>00</sup>

**SET 6 CHIAVI PER FILTRI OLIO (COLORATE)**  
**KIT OF 6 WRENCHES FOR OIL FILTERS (COLOURED)**  
**JUEGO DE 6 LLAVES PARA FILTROS ACEITE (COLORADAS)**



**IL KIT INCLUDE: THE KIT INCLUDES: EL KIT INCLUYE:**

	COLORE COLOUR COLOR	APPLICAZIONI USES USOS	Ømm/lati sides lados
A	Rosso - Red - Rojo	Mercedes Benz Jeep - Chrysler	Ø84 - 14
B	Verde - Green - Verde	BMW - Volvo	Ø86 - 16
C	Blu - Blue - Azul	Kia Hyundai	Ø89 - 15
D	Giallo - Yellow - Amarillo	Alfa Romeo - Fiat Opel - Suzuki	Ø75 - 16
E	Azzurro - Light Blue Azul claro	Hyundai	Ø77 - 15
F	Celeste - Pale blue Azul palido	Alfa Romeo, Fiat, Lancia	Ø90 - 10



Cod. 05.062.05

€ 11,<sup>90</sup>

Pinza per filtri olio Ø46mm (VW, Audi, Skoda, Seat)

Pliers for oil filters Ø46mm (VW, Audi, Skoda, Seat)

Alicates para filtros de aceite Ø46mm (VW, Audi, Skoda, Seat)

Cod.02.022.113

€ 166,00



**POMPA MANUALE PER L'INSERIMENTO DI OLIO NEI CAMBI MANUALI, AUTOMATICI E NEI DIFFERENZIALI**

- Il kit include 12 adattatori per la connessione diretta
- Valvola di non ritorno per un'efficace azione di inserimento dell'olio senza perdite
- Portata: 70cc a pompata
- Capacità serbatoio: 7 lt
- Massima viscosità olio utilizzabile: SAE 140

**MANUAL PUMP FOR THE INSERTION OF OIL IN MANUAL, AUTOMATIC AND DIFFERENTIAL TRANSMISSIONS**

- The kit includes 12 adapters for direct connection
- Non-return valve for an effective oil insertion action without leaks
- Flow: 70cc per stroke
- Tank capacity: 7 lt
- Maximum viscosity of usable oil: SAE 140

**BOMBA MANUAL PARA LA INSERCIÓN DE ACEITE EN TRANSMISIONES MANUALES, AUTOMÁTICAS Y DIFERENCIALES**

- El kit incluye 12 adaptadores para conexión directa
- Válvula de retención para una acción efectiva de inserción de aceite sin fugas
- Flujo: 70cc por carrera
- Capacidad del tanque: 7 lt
- Viscosidad máxima del aceite utilizable: SAE 140

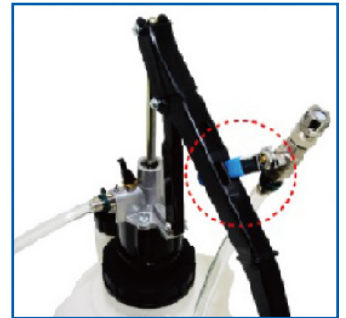

FORD 1/8 NPT	AT-101
UNIVERSAL (BMW, Honda, Nissan etc.)	AT-102
VW-AUDI	AT-103
VW-AUDI-PORSCHE	AT-104
VW-AUDI-MINI COOPER 10X1.0	AT-105
MERCEDES 722.9 12X1.5	AT-106
DSG 24X1.5	AT-107
VW-AUDI CVT 22X1.5	AT-108
VOLVO 5/16X24	AT-109
TOYOTA-LEXUS 18X1.5	AT-110
SKODA 30X1.5	AT-111
VW PASSAT/TIGUAN <2007	AT-112

Cod. 05.056.16

€ 27,93

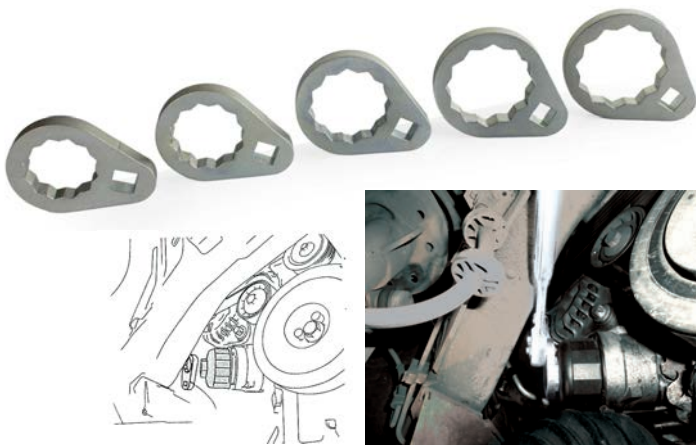

Set 5 chiavi esagonali per smontaggio filtri olio in zone di difficile accesso - Ø3/8"

Set of 5 hexagonal wrenches for oil filters removal in difficult-to-access areas - Ø3/8"

Juego de 5 llaves hexagonales para la extracción de filtros de aceite en zonas de acceso difícil - Ø3/8"

Misure: Measures: Medidas: 24/27/32/36/38mm



Cod. 05.067.01

€ 39,00

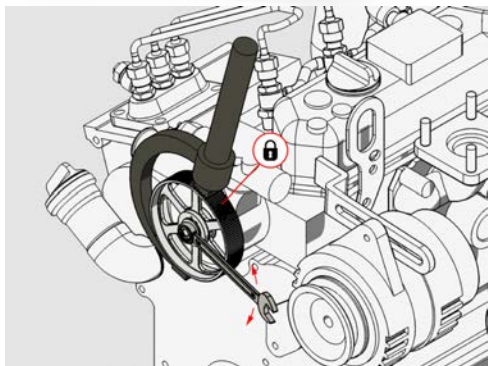

**UTENSILE UNIVERSALE A MEZZALUNE BLOCCAPULEGGIE PER SMONTAGGIO PULEGGIE DI DISTRIBUZIONE**

Regolabile tramite manico girevole, blocca la puleggia dell'esterno evitando eventuali danni a sensori circostanti

**UNIVERSAL CRESCENT-SHAPED TOOL FOR HOLDING PULLEYS IN POSITION AND DISMANTLING DISTRIBUTION PULLEY**

Adjustable via turning handle, it locks the pulley from outside avoiding damage to surrounding sensors

**HERRAMIENTA UNIVERSAL EN FORMA DE MEDIALUNA PARA SUJETAR POLEAS EN POSICIÓN Y DESMONTAR LA POLEA DE DISTRIBUCIÓN**

Ajustable mediante mango giratorio, bloquea la polea para evitar daños a los sensores circundantes

Cod. 05.090.75

€ 9,00



Chiave smontaggio tappi olio in plastica (Gruppo VW-Audi)

Wrench for dismantling oil caps in plastic (VW-Audi Group)

Llave para desmontar las tapas de aceite en plástico (Grupo VW-Audi)

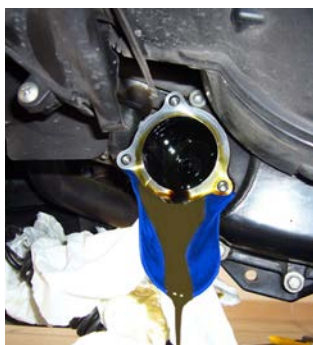

Cod.03.036.25

€ 21,00

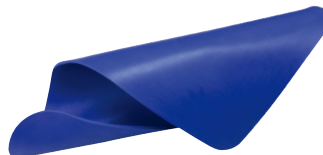

Convogliatore olio in alluminio rivestito in gomma  
Aluminum oil conveyor coated in plastic  
Embudo transportador aceite recubierto en plástico

Cod. 05.062.01

€ 33,50



Pinza per serraggio e taglio fascette in acciaio inox  
Pliers for tightening and cutting stainless steel clamps  
Pinza para apretar y cortar abrazaderas de acero inoxidable

Cod. 05.090.76

€ 34,00

**ESTRATTORE PER GIUNTI OMOCINETICI  
PULLER FOR HOMOKINETIC JOINTS  
EXTRACTOR DE JUNTAS HOMOCINÉTICAS**

Permette l'estrazione dei giunti omocinetici incastrati e difficilmente rimovibili. Particolarmente indicato per vetture gruppo VAG, Ford, Fiat, CSA, BMW, Mercedes Benz, Suzuki, Volvo, Opel

**LAVORA DIRETTAMENTE SUL VEICOLO**

It allows the extraction of stuck and difficult to remove homokinetic joints. Especially designed for VAG, Ford, Fiat, CSA, BMW, Mercedes Benz, Suzuki, Volvo, Opel group cars

**IT WORKS DIRECTLY ON THE VEHICLE**

Permite la extracción de juntas homocinéticas pegadas y difíciles de quitar. Especialmente diseñado para los coches del grupo VAG, Ford, Fiat, CSA, BMW, Mercedes Benz, Suzuki, Volvo, Opel. Trabaja directamente sobre el vehículo

**TRABAJA DIRECTAMENTE SOBRE EL VEHÍCULO**

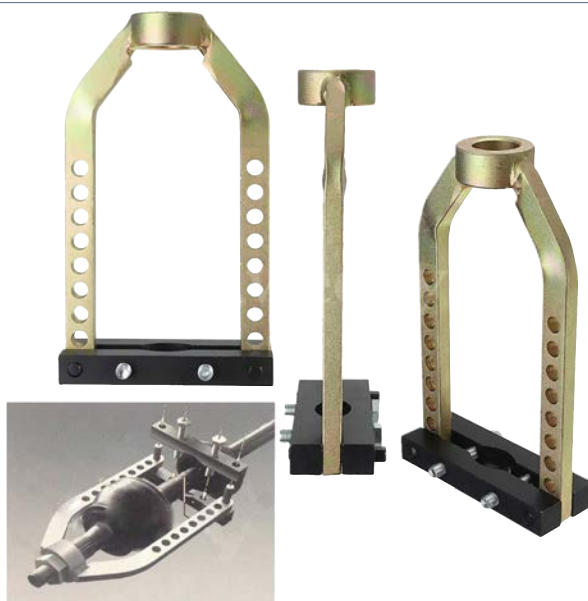





Cod. 02.016.04

€ 79,00

**NUOVO KIT MASTER PER CONTROLLO PORTATA DI RITORNO**

*impianto common rail*

**NEW KIT MASTER FOR THE BLACK FLOW CONTROL**  
*of common rail systems*

**NUEVO KIT MASTER PARA EL CONTROL DE LA CAPACIDAD DE RETORNO**  
*de las instalaciones common rail*

Permette un rapido controllo delle portate di iniettori Bosch, Siemens, Delphi dei principali sistemi common rail (auto e veicoli commerciali) identificando eventuali anomalie.

It enables you to perform a quick control of the back flow of the main common rail systems (cars and commercial vehicles) detecting possible anomalies.

Permite un control rápido de las capacidades de retorno de los inyectores Bosch, Siemens, Delphi de las principales instalaciones common rail (coches y vehículos comerciales) detectando posibles anomalías.

**Il kit include:**

1. Rampa con 8 burette graduate, 8 tubi e raccordi dritti per collegamento alle uscite degli iniettori
2. 8 raccordi per iniettori Delphi
3. 24 raccordi a 90° per iniettori Bosch, Siemens, Delphi
4. 8 burette da 10cc per collegamento diretto a iniettori common rail Mercedes.

**The kit includes:**

1. Manifold with 8 graduated burettes, 8 straight hoses and couplings for the connection to the injector outlet.
2. 8 couplings for Delphi injectors
3. 24 90° couplings for injectors iniettori Bosch, Siemens, Delphi
4. 8 10 cc burettes for direct connection to Mercedes common rail injectors

**El kit incluye:**

1. Rampa con 8 buretas graduadas, 8 tubos y empalmes rectos para la conexión a las salidas de los inyectores
2. 8 empalmes para inyectores Delphi
3. 24 empalmes de 90° para inyectores Bosch, Siemens, Delphi
4. 8 buretas de 10cc para la conexión directa a inyectores common rail Mercedes

Cod. 05.090.70

58,00

**KIT 17PCS FRESE PER SEDI GUARNIZIONI PARAFIAMMA/INIETTORI DIESEL**

**17PCS SET OF FIREPROOF SEALS/DIESEL INJECTORS SEAT CUTTERS**

**JUEGO DE 17 PCS DE CORTADORES DE ASIENTO PARA GUARNICIONES IGNIFUGAS/ INYECTORES DIESEL 1PZ**

- 1pc 15.5mm x 15.5mm
- 1pc 17mm x 17mm
- 1pc 17mm x 21mm
- 1pc 14mm x 14mm
- 1pc 15mm x 15mm
- 1pc 15mm x 19mm
- 1pc 17mm x 17mm
- 1pc 17mm x 17.5mm
- 1pc 17mm x 19mm
- 1pc 17mm x 19.5mm
- 1pc 17mm x 20mm
- 1pc 17.5mm x 20.5mm
- 1pc 19mm x 21.5mm
- 1pc
- 1pc
- 1pc 15.5mm x 225mm
- 1pc 2.5mm

- fresa angolare/angled reamer/fresadora angular
- fresa angolare/angled reamer/fresadora angular
- fresa angolare /angled reamer/fresadora angular
- fresa piana/flat reamer/fresadora regular
- fresa piana/flat reamer/fresadora regular
- fresa piana/flat reamer/fresadora regular
- fresa piana/flat reamer/fresadora regular
- fresa piana/flat reamer/fresadora regular
- fresa piana/flat reamer/fresadora regular
- fresa piana/flat reamer/fresadora regular
- fresa piana/flat reamer/fresadora regular
- fresa piana/flat reamer/fresadora regular
- fresa piana/flat reamer/fresadora regular
- manico a "T"/T-handle/mango en T
- Pilo Post
- fresa/cutter/cortador
- chiave esagonale/hex key/llave hexagonal

Cod. 02.020.05

€ 290,00

**POMPA MANUALE PER PROVA INIETTORI DIESEL**

*fino a 600 bar*

**MANUAL PUMP FOR DIESEL INJECTOR TESTER**

*up to 600 bars*

**BOMBA MANUAL PARA PROBA INYECTORES DIESEL**

*hasta 600 bar*



PROMO 2022/2



Cod. 05.090.47

€ 130,00

M8-M9-M10

**KIT RIMOZIONE CANDELETTE  
GLOW PLUG DRILLING SET  
KIT DE EXTRACCION DE BUJIAS DE PRECALENTAMIENTO**

Semplice estrazione di candele  
danneggiate o ingrippate su molti  
moderni motori diesel  
Non necessaria la rimozione della  
testa del cilindro che potrebbe  
danneggiare lo stampo  
Adatto a motori diesel Mercedes  
Benz CDI

Easy extraction of the damaged/  
seized glow plugs on many  
modern diesel engines  
No cylinder head extraction  
needed which may cause damages  
to cylinder head castings  
Suitable for Mercedes Benz CDI  
diesel engines

Extracción fácil de las bujias  
dañadas / gripadas en muchos  
motores diesel modernos  
No extracción de la culata  
necesaria que puede causar daños  
a la fundición de la culata  
Adecuado para motores diesel  
Mercedes Benz CDI

Cod. 05.090.07

€ 48,00



**SERIE DI 6 BUSSOLE SNODATE  
PER CANDELETTE (LUNGHE)**

**KIT 6 JOINTED SOCKETS  
FOR PLUGS (LONG)**

**KIT DE 6 CASQUILLOS  
PARA BUJIAS (LARGOS)**

8 mm L=155mm;  
9 mm L=155mm;  
10 mm L=155mm;  
11 mm L=155mm;  
12 mm L=155mm;  
14 mm L=155mm;  
16 mm L=155mm;



Per uno smontaggio sicuro delle candele  
anche in posizioni difficili da raggiungere.  
Includono anello in gomma  
per mantenimento candele.

To dismount safely the plugs also those positioned in  
difficult positions to be reached. It includes a rubber ring to  
hold the plug.

Para desmontar en seguridad las bujias que están colocadas  
en zonas difíciles de llegar. Incluye un anillo de goma  
para la bujía.

Cod. 02.024.02

€ 175,00

**POMPA VUOTO E PRESSIONE "MYTIVAC"  
VACUUM AND PRESSURE PUMP "MYTIVAC"  
BOMBA DE VACÍO Y PRESIÓN "MYTIVAC"**

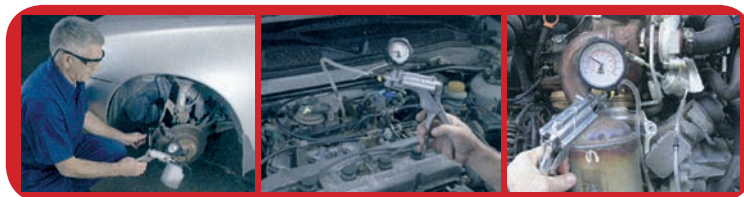

Maggiori prestazioni  
(-1/+4 bar)  
Manometro con protezione in  
gomma rotante a 360° A  
Selezione vuoto-pressione con  
una sola mano  
Impugnatura ergonomica C  
Contenitore olio freni esau-  
stato collegato direttamente alla  
pompa B

Better performance  
(-1/+4 bar)  
Gauge with rubber protection  
rotating 360° A  
Selection vacuum-pressure with  
only one hand  
Ergonomical handle C  
Exhausted brake oil recipient  
connected directly to the pump B

Mayores prestaciones  
(-1/+4 bar)  
Manómetro con protección de  
caucho giratorio de 360° A  
Selección vacío-presión con  
una sola mano  
Empuñadura ergonómica C  
Recipiente de aceite frenos  
usado conectado directa-mente  
a la bomba B



Cod. 04.024.01

€ 119,00

**POMPA A VUOTO E PRESSIONE (-1/3 BAR)  
Completa di accessori in valigetta ABS  
VACUUM-PRESSURE PUMP (-1/3 BAR)  
Supplied with accessories in ABS case  
BOMBA MANUAL PRESIÓN-DEPRESIÓN (-1/3 BAR)  
Con accesorios en maletín de ABS incluidos**

Cod. 04.053.08

€ 145,00



**KIT TEST POMPA INIEZIONE BENZINA**  
**FUEL INJECTION TEST SET**  
**JUEGO DE HERRAMIENTAS PARA LA PRUEBA**  
**DE SISTEMAS DE INYECCIÓN GASOLINA**

**IL KIT INCLUDE:**

- Gli adattatori più comuni per tutti i tipi di sistemi iniezione benzina
- Ampio manometro con doppia lettura Kpa, Psi da 0 a 1000Kpa (10bar)
- Un manometro di bassa pressione per misurazione accurata da 0 a 100Kpa (1bar)
- Sistema di connessione rapida

**THE KIT INCLUDES:**

- The most popular adaptors for all types of fuel injection systems(Petrol)
- A large gauge with dual readings Kpa, Psi from 0 to 1000Kpa (10bar)
- A low pressure gauge for accurate reading from 0 to 100Kpa (1bar)
- Quick coupling system

**EL JUEGO INCLUYE:**

- Los adaptadores más populares para todos los tipos de sistemas de inyección de combustible
- Un gran manómetro con lecturas dobles Kpa, Psi de 0 a 1000 kPa (10 bares)
- Un indicador de presión baja para una lectura precisa de 0 a 100 kPa (1 bar)
- Sistema de acoplamiento rápido

Cod. 04.053.09

€ 35,00

Adattatore per cod. 04.053.08 (per FIAT PANDA / PUNTO)  
Adapter for cod. 04.053.08 (for FIAT PANDA / PUNTO)  
Adaptador para cod. 04.053.08 (para FIAT PANDA / PUNTO)

Art. 060



It detects certainly cracks and water leaks on cylinder heads, seals and engine blocks. The test detector will colour immediately, if there are leaks.

Detecta con precisión grietas y pérdidas en las culatas de los cilindros, en las juntas y en el motor. El líquido de prueba se colora automáticamente en caso de no estanqueidad.

Rivela in modo sicuro incrinature e perdite sulle testate cilindri, sulle guarnizioni e sul blocco motore. Il liquido di prova si colora automaticamente nel caso di mancata ermeticità.

Cod. 04.043.00

€ 70,00

**KIT CONTROLLO TENUTA DI GUARNIZIONI**  
**TESTATE MOTORI BENZINA E DIESE**

**KIT CONTROL SEALS PETROL AND DIESEL ENGINES**  
**CONPROBADOR DE FUGAS DE CULATAS**  
**MOTORES DIESEL Y GASOLINA**

Cod. 04.043.01

€ 24,00



**LIQUIDO DI RICAMBIO**  
**TEST LIQUID**  
**LIQUIDO DE RECAMBIO**

Cod. 05.098.02

€ 49,00

**KIT 114PCS TAPPI COPPA OLIO E DIFFERENZIALI**  
**KIT OF 114PCS OIL PAN AND DIFFERENTIALS CAPS**  
**KIT 114PCS DE TAPAS PARA CÁRTER DE ACEITE Y DIFERENCIALES**



Misure / Sizes / Tallas:

- M13 x 1
- 25-M13 x 1
- 5-M15 x 1
- 5-M17 x 1
- 5-M20 x 1
- 5-M22x1,5mm

Cod. 04.029.01

€ 38,00

**TESTER PROVA PRESSIONE OLIO MOTORE**  
**ENGINE OIL PRESSURE TEST TESTER**  
**TESTER PRUEBA PRESIONES ACEITE MOTOR**



- Manometro doppia scala di facile lettura fino a 10 bar
- Attacchi rapidi con valvole per operare in sicurezza e velocità
- Double-range gauge easily reading up to 10 bar
- Rapid couplings with valves to work safely and quickly
- Manómetro con doble escala, lectura fácil, hasta 10 bar
- empalmes rápidos con válvulas para trabajar en seguridad y rápidamente

Cod. 05.090.08

€ 48,00



**ESTRATTORI PER INIETTORI COMMON RAIL  
COMMON RAIL INJECTORS EXTRACTOR SET  
EXTRACTORES INYECTORES COMMON RAIL**

**THE KIT INCLUDES:**

- Slide Hammer (Kg 1,75)
- adaptor M17x1.0
- adapter M27x1 fro Bosch injector head
- Adapter with M12x1,75

**IL KIT INCLUDE:**

- Martello a battente (Kg 1,75)
- adattatore M17x1.0
- Adattatore M27x1.0 per iniettore CR Bosch
- adattatore M12x1,75

**EL JUEGO INCLUYE:**

- Martillo de oscilacion (Kg 1,75)
- Adaptador M17x1.0
- Adaptador M27x1 para la cabeza del inyector Bosch
- Adaptador con M12x1,75

Cod. 04.053.05

€ 350,00



038K9M/3000

**PROVA COMPRESIONE DIESEL  
(ANCHE COMMON RAIL)**

**COMPRESSION TESTER FOR DIESEL  
(ALSO COMMON RAIL)**

**TESTER PRUEBA COMPRESIÓN DIESEL  
(TAMBIÉN COMMON RAIL)**

Applicazioni / Applications / Aplicaciones:

Alfa Romeo, BMW, Chrysler, Daewoo, Fiat, Ford, Hyundai, ISU24, Landrover, LDV, Mazda, Mercedes, Mitsubishi, Nissan, Opel, PSA, Renault, SAAB, Suzuki, Toyota, VAG, Vauxhall, Volvo  
Injectors: M20, M22, M24 e Ford Stanadyne TDI Injct

Foto indicativa/indicative image

Cod. 04.053.01

€ 72,00



**TESTER PROVA COMPRESIONE MOTORI DIESEL  
(auto e commerciali) con manometro 0-70 (psi)**

**COMPRESSION TESTER DIESEL ENGINES (cars and deliveries vans) with gauge 0-70 (psi)**

**TESTER PRUEBA COMPRESIÓN MOTORES DIESEL  
(coches y vehículos comerciales) con manómetro 0-70 (psi)**

Cod. 04.053.00

€ 49,80



**Tester prova compressione motori benzina con manometro 0-20bar (psi)**

**Il kit include:**

- attacco M10x1,0 (moto)
- attacco M12x1,25 (moto)
- attacco M14x1,25 (2 pezzi)
- attacco M18x1,5
- maschio per filetti M10/M12
- maschio per filetti M14/M18

**Compression tester for petrol engines with manometer 0-20bar**

**The kit includes:**

- M10x1,0 coupling (motorcycles), M12x1,25 coupling (motorcycles)
- M14x1,25 coupling (2 pieces)
- M18x1,5 coupling
- male for threads M10/M12
- male for threads M14/M18

**Tester prueba compresión motores de gasolina con manómetro 0-20bar (psi)**

**El kit incluye:**

- empalme M10x1,0 (moto)
- empalme M12x1,25 (moto)
- empalme M14x1,25 (2 unidades)
- empalme M18x1,5
- macho para filetes M10/M12
- macho para filetes M14/M18

Cod. 04.053.07

€ 39,00

**COPPIA BARRE DI ESTENSIONE PER PROVA COMPRESIONE 12/14MM  
COMPRESSION TEST ADAPTORS (2PCS) 12/14MM  
ADAPTADORES DE PRUEBA DE COMPRESION (2PCS) 12/14MM**



Questo adattatore extra lungo per prova compressione è progettato per adattarsi a candele di 12/14mm  
Questo utensile è essenziale su BMW E90 335i con motori N54 >2006, BMW MINI, MERCEDES M156, FORD DURATECH 16V  
Utilizzabile anche su motori Peugeot 207/307 e Renault 1.2 16 valvole  
Design speciale per estendere la filettatura delle candele in sede profonda per facilitare i test

This extra-long compression test adaptor is designed to fit 12 and 14mm spark plugs  
This tool is now essential on BMW E90 335i with N54 engine 2006, BMW MINI, MERCEDES M156, FORD DURATECH 16V  
Also used on Peugeot 207/307 and Renault 1.2 16 valve engines  
Special design to extend the spark plug thread in the deep hole for easier testing

Este adaptador de prueba de compresión extra largo está diseñado para adaptarse a bujías de 12 y hasta 14 mm. Este instrumento es ahora esencial sobre BMW E90 335i con motor N54 2006, BMW MINI, MERCEDES M156, FORD DURATECH 16V. También se utiliza en Peugeot 207/307 y Renault 1.2 motores de 16 válvulas. Diseño especial para extender el hilo de la bujía en el agujero profundo para pruebas más fáciles.

Cod. 05.090.84

€ 64,00



**SET DI 6 FUSTELLE PER FORATURE PARAFANGHI  
PER MONTAGGIO SENSORI DI PARCHEGGIO**

17/18.2/19/20/21/22mm

per VW, Audi, Skoda, Seat, BMW

**HOLE CUTTING TOOL SET FOR PDC  
(PARK DISTANCE CONTROL)**

17/18.2/19/20/21/22mm

for fenders on VW, Audi, Skoda, Seat, BMW

**JUEGO DE HERRAMIENTAS DE CORTE DE AGUJEROS  
PARA CONTROL DE DISTANCIA DEL PARQUE**

17/18.2/19/20/21/22mm

para guardabarros en VW, Audi, Skoda, Seat, BMW

Cod. 05.090.83

€ 96,00



**INSERITORE A PERCUSSIONE  
PER CUSCINETTI/PARAOLI**

da Ø 18÷90mm, regolabile

Peso: 15,3kg

**PERCUSSION INSERTER  
FOR BEARINGS/OIL SEALS**

from Ø 18÷90mm, adjustable

Weight: 15,3kg

**DISPOSITIVO COLOCADOR DE PERCUSIÓN  
PARA COJINETES/RETENES PARA ACEITE**

de Ø 18÷90 mm, ajustable

Peso: 15,3kg

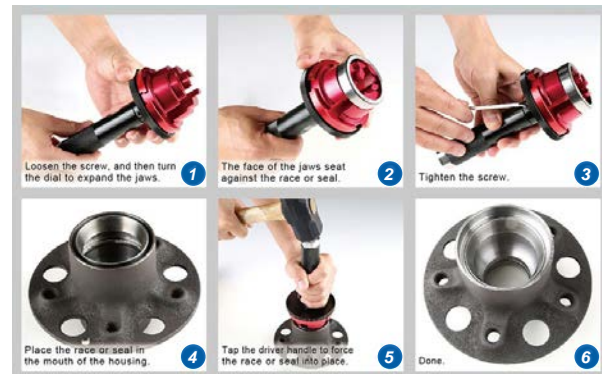

Cod. 05.062.06

€ 15,00

**SET DI 3 PINZE PER MANICHETTA FLESSIBILE**

3 PCS HOSE CLIP PLIERS

JUEGO DE TRES PINZAS PARA MANGUERAS FLEXIBLES

1/2" - 5/8" - 2/4"



Cod. 05.078.07

€ 69,00

**LEVA DI TRAZIONE UNIVERS  
WISHBONE LEVER TOOL  
EXTRACTOR BRAZO DE SUSPENSION**

- Lunghezza: 120cm
- Diametro tubo: 3.5cm
- Distanza fissaggio: 50, 45, 40, 35, 30cm
- Length: 120cm
- Diameter tube: 3.5cm
- Brace distance: 50, 45, 40, 35, 30cm



A blue motorcycle lift is shown in a workshop setting. A dirt bike, primarily orange and black with the number '95' on the side, is mounted on the lift. The lift has a blue metal frame and a blue platform with a perforated surface. The background shows a typical workshop environment with shelves and tools.

**ATTREZZATURE PER MOTOFFICINE  
MOTOR BIKES EQUIPMENT  
EQUIPOS PARA MOTOS**

Cod. 05.085.17

€ 1.360,00

SOLLEVATORE PER MOTO ELETTROIDRAULICO  
ELECTROHYDRAULIC MOTO LIFTER  
ELEVADOR ELECTROHIDRÁULICO PARA MOTOS



- Capacità di sollevamento / Lifting capacity / Capacidad de levantamiento: **600 kgs**
- Dimensioni piattaforma / Platform dimensions / Dimensiones plataforma: **1800 x 600 mm**
- Lunghezza totale / Total length / Longitud total: **2600 mm**
- Telecomando per salita/discesa / Remote control for raise/descent / Mando a distancia para levantar/bajar: **standard**

- Altezza di sollevamento / Lifting height / Altura levantamiento: **260 – 880 mm**
- Apertura morsa / Vise opening / Anchura prensa: **40 – 200 mm**
- Motore / Motor: **230V 50Hz 550W**
- Peso / Weight: **210 kgs**

Cod. 05.085.18

€ 1.680,00

SOLLEVATORE PER MOTO E QUAD ELETTROIDRAULICO  
ELECTROHYDRAULIC MOTO & QUAD LIFTER  
ELEVADOR ELECTROHIDRÁULICO PARA MOTOS Y QUAD



- Capacità di sollevamento / Lifting capacity / Capacidad de levantamiento: **600 kgs**
- Dimensioni piattaforma / Platform dimensions / Dimensiones plataforma: **1800 x 1200 mm**
- Lunghezza totale / Total length / Longitud total: **2600 mm**
- Telecomando per salita/discesa / Remote control for raise/descent / Mando a distancia para levantar/bajar: **standard**

- Altezza di sollevamento / Lifting height / Altura levantamiento: **260 – 880 mm**
- Apertura morsa / Vise opening / Anchura prensa: **40 – 200 mm**
- Motore / Motor: **230V 50Hz 550W**
- Peso / Weight: **280 kgs**

Cod. 05.085.04L

€ 550,00

**PONTE SOLLEVATORE PER MOTO/SCOOTER**  
con pompa idraulica a pedale

**LIFT FOR MOTORCYCLES/SCOOTERS**  
equipped with foot hydraulic pump

**LEVANTADOR HIDRÁULICO DE PESO**  
accionado por pie para motos /scooters

- Capacità: 450 Kg
- Altezza min: 18,5 cm
- Altezza max: 85 cm
- Misura piano con rampa laterale: 266x65 cm
- Misura piano: 220x65 cm
- Misura rampa laterale: 60x65 cm
- Dimensione imballi: 224x70x21 cm
- Imballo in legno
- Peso lordo: 167,8kg
- Peso netto: 145,5kg
- Colore: Blu Ral 5015

- Capacity: 450 Kg
- Min.Height: 18,5 cm
- Max.Height: 85 cm
- Table size with side ramp: 266x65cm
- Table size: 220x65cm
- Side ramp size: 60x65cm
- Package size: 224x70x21 cm
- Plywood Cases
- G.W.: 167,8kg
- N.W.: 145,5kg
- Color: Blue Ral 5015

- Capacidad: 450 Kg
- Altura Min.: 18,5 cm
- Altura Max.: 85 cm
- Tamaño de la superficie de apoyo con placa lateral: 266x65cm
- Tamaño de la superficie de apoyo: 220x65cm
- Placa lateral: 60x65 cm
- Tamaño del embalaje: 224x70x21 cm
- Embalaje Plywood
- Peso bruto: 167,8kg
- Peso neto: 145,5kg
- Color: Azul Ral 5015



Cod. 05.085.04C

€ 430,00

**PONTE SOLLEVATORE PER MOTO/SCOOTER**  
con pompa idraulica a pedale

**LIFT FOR MOTORCYCLES/SCOOTERS**  
equipped with foot hydraulic pump

**LEVANTADOR HIDRÁULICO DE PESO**  
accionado por pie para motos /scooters

- Capacità: 360Kg
- Altezza min: 20 cm
- Altezza max: 85 cm
- Misura piano con rampa laterale: 220x49 cm
- Misura piano: 135x49 cm
- Misura rampa laterale: 85x49cm
- Dimensione imballi: 150x80x40 cm
- Imballo in legno
- Peso lordo: 120 kg
- Peso netto: 107 kg
- Colore: Blu Ral 5015

- Capacity: 360 Kg
- Min.Height: 20 cm
- Max.Height: 85 cm
- Table size with side ramp: 220x49 cm
- Table size: 135x49 cm
- Side ramp size: 85x49cm
- Package size: 150x80x40 cm
- Plywood Cases
- G.W.: 120 kg
- N.W.: 107 kg
- Color: Blue Ral 5015

- Capacidad: 360 Kg
- Altura Min.: 20 cm
- Altura Max.: 85 cm
- Tamaño de la superficie de apoyo con placa lateral: 220x49 cm
- Tamaño de la superficie de apoyo: 135x49 cm
- Placa lateral: 85x49cm
- Embalaje Plywood
- Tamaño del embalaje: 150x80x40 cm
- Peso bruto: 120 kg
- Peso neto: 107 kg
- Color: Azul Ral 5015



**RAMPA IN ALLUMINIO RICHIUDIBILE E TRASPORTABILE**  
**ALUMINUM CLOSABLE AND PORTABLE RAMP**  
**RAMPA DE ALUMINIO RECERRABLE Y PORTÁTIL**



FINE SERIE  
SELL OUT

Cod. 05.087.04

€ 130,00

- Portata/ Capacity/ Capacidad: 270 kg
- Dimensioni/dimensions: 123x38x8cm
- Peso/ Weight: 9,5kg /11,5 kg

270  
Kg

Cod. 05.087.16

€ 210,00

- Portata/ Capacity/ Capacidad: 300 kg
- Dimensioni/dimensions: 185x38x8cm
- Peso/ Weight: 18kg /20,5 kg

300  
Kg



Cod. 05.085.05

€ 148,00

**SOLLEVATORE IDRAULICO A PEDALE**

per scooter e moto da cross

**FOOT HYDRAULIC WEIGHT LIFTER**

for scooters and enduros

**LEVANTADOR HIDRÁULICO DE PESO ACCIONADO POR PIE**

para motos y enduros

- |                          |                         |                         |
|--------------------------|-------------------------|-------------------------|
| • Capacità: 135kgs       | • Load range: 135kgs    | • Capacidad: 135kgs     |
| • Altezza minima: 340mm  | • Minimum height: 340mm | • Altura mínima: 340 mm |
| • Altezza massima: 890mm | • Maximum height: 890mm | • Altura máxima: 890mm  |
| • Peso: 28,5kgs          | • Weight: 28,5kgs       | • Peso: 28,5kgs         |



Cod. 05.085.14

€ 62,80

**CAVALLETTI DI SOLLEVAMENTO MOTO SU PONTE**

MOTO LIFTING EASEL FOR MOTO LIFTER

GATO DE ELEVACIÓN MOTOS PARA LEVANTADORES DE MOTOCICLETAS



- |                               |                            |                               |
|-------------------------------|----------------------------|-------------------------------|
| • Capacità max: 500g          | • Max.Capacity: 500g       | • Capacidad max: 500g         |
| • Altezza max.: 420mm         | • Max.Height:420mm         | • Altura max.: 420mm          |
| • Altezza min.: 90mm          | • Min Height:90mm          | • Altura min.: 90mm           |
| • Dim. piattaforma: 450x150mm | • Platform size:450x150mm  | • Dim. plataforma: 450x150mm  |
| • Peso netto: 15KG            | • Net weight:15KG          | • Peso: 15KG                  |
| • Dim. imballo: 495x310x90mm  | • Carton size:495x310x90mm | • Dim. embalaje: 495x310x90mm |

Cod. 05.085.10

€ 119,00

**CAVALLETTI SPOSTA MOTO IN ACCIAIO VERNICIATO**

MOVABLE MOTORCYCLE STAND IN PAINTED STEEL

SOPORTE MÓVIL PARA MOTOCICLETAS EN ACERO PINTADO



Permette di posteggiare e spostare in spazi ristretti (officine/show room) scooter e moto di grossa cilindrata dotate di cavalletto laterale

- Portata: 570kgs
- Materiale: acciaio verniciato
- Max lunghezza: 200cm
- Max larghezza: 20cm
- 5 ruote da 2" doppie piroettanti
- Dim. Max attrezzo montato: 211x80x9cm
- Dim. Imballo: 198x31x9cm
- Peso netto/lordo: 30/31.5kgs

It allows to park and move in confined spaces (workshops/showrooms) scooters and big bikes equipped with side stands

- Capacity: 570kgs
- Material: painted steel
- Max length: 200cm
- Max width: 20cm
- 5 x 2" double castor wheels
- Max dim. assembled device: 211x80x9cm
- Packaging Dim.: 198x31x9cm
- Net/gross weight: 30/31.5kgs

Permite aparcar y mover en espacios confinados (talleres/salas de exposición) scooters y motocicletas equipadas con soportes laterales

- Capacidad: 570kgs
- Material: acero pintado
- Longitud máxima: 200cm
- Ancho máximo: 20 cm
- 5 x 2" ruedas pivotantes dobles
- Dim. Maxima dispositivo montado: 211x80x9cm
- Embalaje Dim.: 198x31x9cm
- Peso bruto/neto: 30/31.5kgs

PROMO 2022/2

Cod. 05.090.62

€ 30,00

**SET 11 CHIAVI COMBinate**  
KIT OF 11 COMBINED WRENCHES  
JUEGO DE 11 LLAVES COMBINADAS

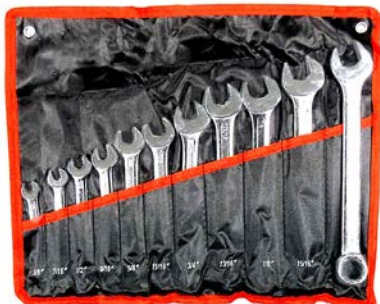

- 3/8"
- 7/16"
- 1/2"
- 9/16"
- 5/8"
- 11/16"
- 3/4"
- 13/16"
- 7/8"
- 5/16"
- 1"

Cod. 05.090.63

€ 28,50

**SET PER LA SEPARAZIONE E RIVETTATURA DI CATENE MOTOCICLI**  
idoneo per catene da 35 a 630  
3 punti di separazione (2,2mm, 2,9mm 3,8mm)

**SET FOR THE SEPARATION AND RIVETING OF MOTORCYCLES CHAINS**  
suitable for chains from 35 to 630  
3 points of separation (2.2mm, 3.8mm 2.9mm)

**CONJUNTO PARA LA SEPARACIÓN Y EL REMACHADO DE LAS CADENAS DE MOTOCICLETAS**

apto para cadenas de 35 a 630  
3 puntos de separación (2,2mm, 3,8mm 2,9mm)



Cod. 05.090.64

€ 69,00

**SET 10 ESTRATTORI ROTORE**  
KIT OF 10 ROTOR'S EXTRACTORS  
KIT DE 10 EXTRACTORES ROTOR

(Honda, Suzuki, Yamaha, Bosch, Ducati, Kawasaki)



Cod. 05.090.65

€ 69,00

**DISTANZIATORE PER PINZE FRENI**  
SPACER FOR BRAKE CLAMPS  
ESPACIADOR PARA PINZAS FRENO



Cod. 05.085.07

€ 62,00

**CAVALLETTO FERMA MOTO**  
MOTORCYCLE STAND  
SOPORTE PARA MOTOCICLETAS

- Portata/capacity/capacidad: 200 kgs
- Dimensioni imballo/packaging dim/dim. del embalaje: 640x540x160mm
- Peso/weight/peso: 11,5kgs



Cod. 05.088.128

€ 112,00

**SET DI 3 CONTENITORI PORTA TUTTO IN TELAIO DI ALLUMINIO**  
per lavoro - tempo libero - sport

**SET OF 3 STORAGE BOXES IN ALUMINUM FRAME**  
for work - leisure - sport

**JUEGO DE 3 CAJAS DE ALMACENAMIENTO CON ESTRUCTURA DE ALUMINIO**  
para el trabajo - tiempo libre - deporte



CHROME  
VANADIUM



Cod. 05.090.49

€ 136,00

CHIAVI A BUSSOLA 219 PZ  
(1/2" - 3/8" - 1/4")  
+ CHIAVI COMBinate

E19PCS 1/2" - 3/8" - 1/4"  
DR. SOCKET WRENCH SET  
+ COMBINATION SPANNER



CHROME  
VANADIUM



Cod. 05.090.17

€ 29,90

CASSETTA BUSSOLE 1/4" (46PZ)  
46- PCS SOCKET SET, 1/4"

- Bussole "super lock" da 4 a 13mm
- Inserti piani, croce, esagonali e torx
- Cricchetto reversibile a 45 denti
- Realizzato in conformità con le norme DIN
- T-Star kit bussole di diverse misure
- Materiale: cromo vanadio
- Super lock sockets from 4 to 13mm
- Comes with plain slot, cross slot, hexagon and 45 tooth reversible ratchet with quick release button
- Made according to DIN standards
- T-Star prese bit di diverse dimensioni
- Matt chrome vanadium

CHROME  
VANADIUM



Cod. 05.090.16

€ 86,00

SET BUSSOLE INSERTI DA 1/4" E 1/2" (108 PZ)  
108-PCS SOCKET SET, 1/4" AND 1/2"

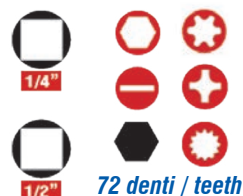

- 6.3 (1/4) drive:  
Ratchet, short extension, long extension, universal joint, sliding T-handle  
Super lock sockets in the following sizes: 4-4,5-5-5,5-6-7-8-9-10-11-12-13 and 14mm  
Super lock deep sockets in following sizes: 6-7-8-9-10-11-12-13mm  
T Star bit sockets: T8-T10-T15-T20-T25-T27-T30  
4x cross bit sockets and 3x slot bit sockets  
Hex bit sockets: 3-4-5-6mm  
E-type sockets: E4-E5-E6-E7-E8

- 12.5 (1/2) drive:  
Rauche, short extension, long extension, universal joint, sliding T-handle  
Super lock sockets in the following sizes: 10-11-12-13-14-15-16-17-18-19-20-21-22-24-27-30-32mm  
Super lock deep sockets in sizes: 14-15-17-19-22mm  
1x bit holder  
T Star bits: T40-T45-T50-T55-T60  
6 x cross bits and 3 slotted bits  
Hex bits: 7-8-9-10-12-14mm  
E-type sockets:  
E10-E11-E12-E14-E16-E18-E20-E24  
Spark plug sockets: 16 and 21mm

**CASSETTE BASE PER OGNI OFFICINA MECCANICA**  
**BUSSOLE IN ACCIAIO AL CROMO-VANADIO TRATTATO E CROMATO FORNITE IN CASSETTA IN MATERIALE PLASTICO COMPOSITO**

**BASIC SETS FOR EVERY MECHANICAL WORKSHOP**

**SOCKETS IN TREATED AND CHROMIUM-PLATED VANADIUM CHROMIUM IN A CASE OF COMPOSITE PLATIC MATERIALS**

Cod. 05.089.00

€ 58,70



Set 30 pz chiavi bussola con esagono maschio attacco **1/2"**  
 Set of 30 pcs exagonal male coupling wrenches

**Contenuto - It contains:** L 55 mm 5-6-7-8-10-12-14-17-19  
 L 100 mm 5-6-7-8-10-11-12-13  
 L 140 mm 5-6-8-10-12-14  
 L 200 mm 5-6-7-8-10-12

Cod. 05.090.00

€ 55,00



Set 26 bussole con inserto ZNX **1/2"**  
 Set sockets with ZNX insert (26 pieces)

**Contenuto - It contains:** L 55 mm 5-6-7-8-9-10-12-14-16  
 L 100 mm 5-6-8-9-10-12-14  
 L 140 mm 5-6-8-9-10-12-14  
 L 200 mm 8-10-12-14

Cod. 05.090.01

€ 59,50



Set 32pz bussole con inserto TX **1/2"**  
 Set sockets with TX (32 pieces)

**Contenuto It contains:** L 55 mm T20-25-27-30-40-45-50-55-60-70  
 L 100 mm T20-25-27-30-40-45-50-55-60-70  
 L 140 mm T40-45-50-55-60-70  
 L 200 mm T40-45-50-55-60-70

Cod. 05.090.02

€ 64,00

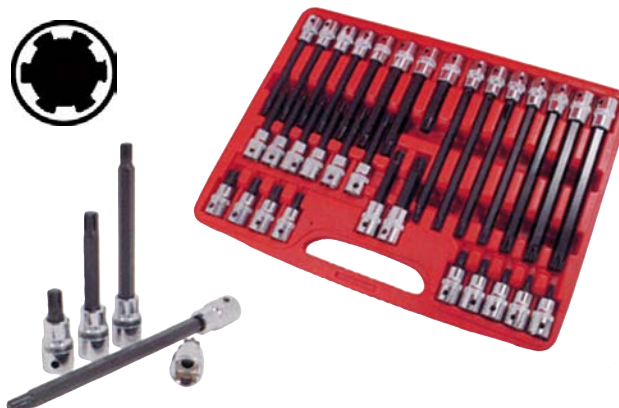

Set 32pz bussole con inserto RIBE **1/2"**  
 Set sockets with RIBE (32 pieces)

**Contenuto It contains:** L 55 mm 5-6-7-8-9-10-12-13-14  
 L 100 mm 5-6-7-8-9-10-12-13-14  
 L 140 mm 8-9-10-12-13-14

Cod. 05.090.05

€ 89,00

Set di 15 bussole per lo smontaggio Set of 15 sockets for the dismantling  
 Set de 15 boussole pour le démontage

10-11-12-13-14-15-17-19-21-24-27mm

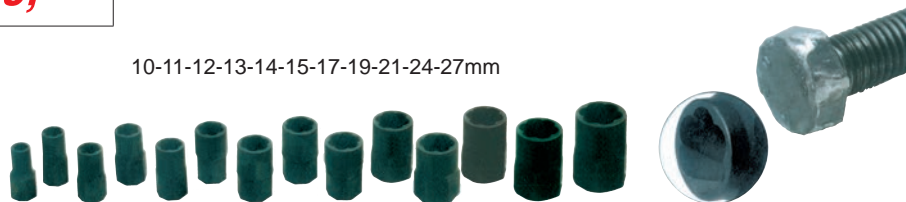

PROMO 2022/2

Cod. 05.078.04

€ 47,00



**SET CHIAVI COMBinate PER ALTERNATORI (22 PZ)**  
**KIT OF COMBINED WRENCHES FOR ALTERNATORS (22PCS)**

**APPLICAZIONI / APPLICATION:**  
ALTERNATORI - ALTERNATORS: BOSCH - DENSO

**MARCHI/ BRANDS:**  
VW - AUDI - MERCEDES BENZ - RENAULT - PEUGEOT CITROEN - BMW - OPEL - FORD - FIAT - HONDA - PORSCHE



Cod.05.090.23

€ 16,50

**ALLARGAFORI A GRADINI 3 PZ**  
**STEPPED HOLE ENLARGER 3 PCS**  
**ENLARGADORA DE AGUJEROS ESCALONADA**

- Ideale per forare lamine di metallo sottili senza deformarle
- Per tutti i tipi di metallo e plastica industriale e lamine fino a 3 mm di spessore
- Contenuto: 1x4-12mm, 1x4-20mm, 1x4-32mm
- Valigetta in legno
- Ideal for drilling thin metal sheets without distorting
- For all types of metal, industrial plastic and sheet metal up to 3 mm thick
- Content: 1x4-12mm, 1x4-20mm, 1x4-32mm
- Wooden cas
- Ideal para la perforación de chapas sin deformarlas
- Para todo tipo de metal, plástico industrial y chapas de hasta 3 mm de espesor
- Contenido: 1x4-12mm, 1x4-20mm, 1x4-32mm
- Caja de maderae

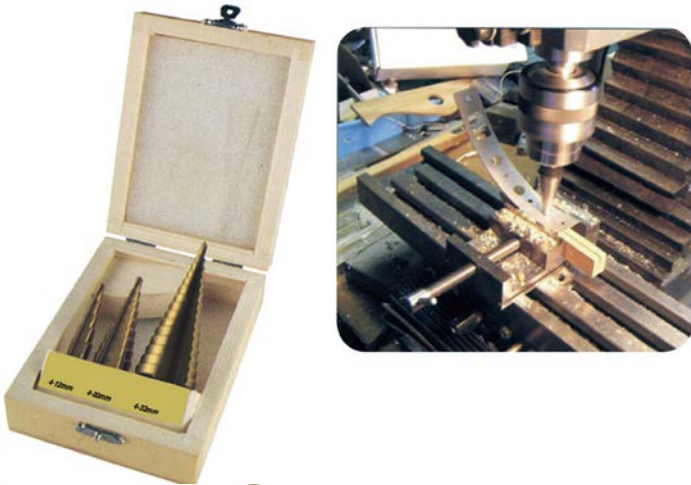

CHROME  
VANADIUM

Cod. 05.090.52

€ 98,00

**SET 13 CHIAVI COMBinate A CRICCHETTO 8 ÷ 32 MM**  
**13 COMBINATION SPANNER RATCHETS SET 8 ÷ 32 MM**  
**JUEGO DE 13 LLAVES COMBINADAS 8 ÷ 32 MM**



Cod. 05.090.26

€ 43,00

**KIT 14 CHIAVI A PIPA**  
14 DOUBLE ENDED OFFSET HEXAGON WRENCHES KIT JUEGO DE  
14 LLAVES EXTENSIBLES HEXAGONALES



Cod. 05.090.29B

€ 69,00

**IT 7 CHIAVI A "T" SNODATE**  
7 T-BENDED WRENCHES KIT  
JUEGO DE LLAVES DE CUBO A "T"



- Con termoformato
- With thermoformed base
- Con base termoformada
- 7, 8, 10, 11, 13, 15, 17 mm

Cod. 05.090.48

€ 34,00

**CRICCHETTO 1/2" ESTENSIBILE**  
1/2" EXTENDIBLE RATCHET



Cod. 05.090.15

€ 57,00

**SET DI 25 CHIAVI COMBinate 6-32MM**  
25-PCS COMBINATION SPANNER SET, 6-32MM

CHROME  
VANADIUM



**Set di 25 chiavi combinate 6-32mm**

In acciaio al cromo-vanadio  
6-7-8-9-10-11-12-13  
14-15-16-17-18-19-20-21  
22-23-24-25-26-27-28-30-32mm  
Custodia in tetron  
conforme a norma din 3113 A

**25-piece Combination Spanner Set, 6-32mm**

All parts manufactured from chrom vanadium-steel;  
Hardened, chrome plated  
6-7-8-9-10-11-12-13  
14-15-16-17-18-19-20-21  
22-23-24-25-26-27-28-30-32mm  
Packed in a tetron wallet  
According to DIN 3113 A

Cod. 05.090.14

€ 27,00

**SET 12 CACCIAVITI CON ESAGONO ESTERNO**  
per una maggior coppia, usando una chiave a bussola

**SCREWDRIVER KIT, 12PCS, END-TO-END HEX BLADE**  
with outer hexagon for extra torque using a spanner or socket

**JUEGO DE 12 DESTORNILLADORES CON HEXÁGONO EXTERNO**  
para más torque, usando una llave de tubo



Cod. 05.086.00

€ 159,00

EASY STEP INDUSTRIAL



**SCALA PER LA MANUTENZIONE INDUSTRIALE**

*l'assistenza tecnica in genere*

**LADDER FOR INDUSTRIAL MAINTENANCE**

*and general technical assistance*

**ESCALERA PARA EL MANTENIMIENTO**

*industrial y la asistencia técnica general*

Altezza massima: / Maximum height:	3,80 mt
Altezza máxima: /	
Altezza mínima: / Minimum height:	95 cm
Alteza mínima: /	
Portata: / Capacity: / Capacidad:	150 kg
Peso: / Weight: / Poids:	11 kg



EN131

IN COMPLIANCE WITH EN CONFORMIDAD CON EN CONFORMITÉ AVEC ATTREZZATURE A NORMA



Cod. 05.086.05

€ 109,00

EASY STEP HOME



**SCALA PER USO PRIVATO O PROFESSIONALE**

*LADDER FOR PRIVATE AND PROFESSIONAL USE*

*ESCALERA PARA USO PRIVADO Y PROFESIONAL*

Altezza massima: / Maximum height:	2,60 mt
Altezza máxima: /	
Altezza mínima: / Minimum height:	83 cm
Alteza mínima: /	
Portata: / Capacity: / Capacidad:	150 kg
Peso: / Weight: / Poids:	6 kg

EN131

IN COMPLIANCE WITH EN CONFORMIDAD CON EN CONFORMITÉ AVEC ATTREZZATURE A NORMA

- Compatta
- Si chiude e si apre in un minuto
- con dispositivo "salvadita"
- Compact
- Open and close in 1 minute
- With "finger-saving" device
- Compacto
- Se abre y se cierra en 1 minuto
- Con dispositivo de "ahorro de dedos"

Cod. 05.086.11

€ 26,00

3 gradini/steps/escalones

quantità limitata

Cod. 05.086.12

€ 45,00

6 gradini/steps/escalones

quantità limitata

**SCALA IN ALLUMINIO, TIPO DOMESTICO**  
**ALUMINUM LADDER, HOUSEHOLD TYPE**  
**ESCALERA DE ALUMINIO, TIPO DOMÉSTICO**

	Cod. 05.086.11 3 gradini/steps	Cod. 05.086.12 6 gradini/steps
Dimensioni/dimensions	40,5x61x111 cm	45x85x17,4 cm
Dimensioni imballo/package dim.	118x33x24 cm	181x36,5x24 cm



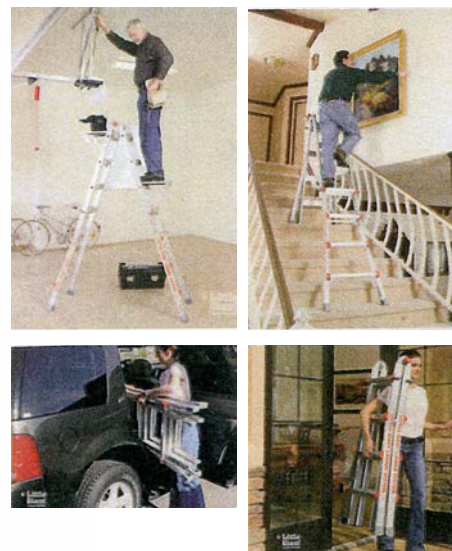

**EN131** IN COMPLIANCE WITH EN CONFORMIDAD CON EN CONFORMITÉ AVEC ATTREZZATURE A NORMA

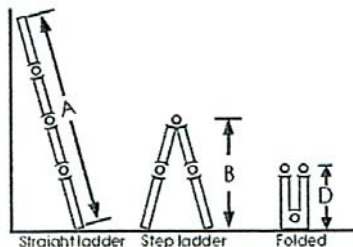

	Cod. 05.086.14	Cod. 05.086.15	Cod. 05.086.16
<b>Gradini/steps</b>	3+3	4+4	5+5
<b>A size</b>	2900	3840	5100
<b>B size</b>	1420	1940	2460
<b>D Size</b>	940	1220	1500
<b>Prezzo promo / Promo price</b>	<b>€ 102,00</b>	<b>€ 122,00</b>	<b>€ 152,00</b>

PROMO 2022/2

Cod. 05.087.13

**€ 96,00**

**EN131** IN COMPLIANCE WITH EN CONFORMIDAD CON EN CONFORMITÉ AVEC ATTREZZATURE A NORMA

**PEDANA IN ALLUMINIO**  
**ALUMINIUM PLATFORM**  
**PLATAFORMA DE ALUMINIO**

- per carrozzerie, officine meccaniche, artigiani, edilizia, manutentori
- for body parts workshops, mechanic workshops, maintenance technicians
- para chapistas, talleres mecanicos, tecnicos de mantenimiento

Portata:	Load range:	Rango de carga:	200kgs
Dimensioni:	Dimensions:	Dimensiones:	1016x410x585mm
Peso:	Weight:	Peso:	8,5 kgs





**ATTREZZATURE PER CARROZZERIE  
CAR BODY SHOPS EQUIPMENT  
EQUIPO PARA CHAPA Y PINTURA**

**PROMO 2022/2**

Cod. 05.085.20

Prezzo a richiesta  
Price on request**PONTE A FORBICE ELETTROIDRAULICO DA 2,7 TON**  
per carrozzerie**2,7 TONS LOW-RISE ELECTRO-HYDRAULIC SCISSOR LIFT**  
for body shops**ELEVADOR DE TIJERA ELECTROHIDRÁULICO DE 2,7 TONELADAS**  
para talleres de carrocería**CARATTERISTICHE TECNICHE:**

- Sollevatore elettroidraulico mobile
- Portata: 2700 kg
- Potenza motore: 2,2 kw, 230V 1ph
- Altezza di sollevamento: 180 ÷ 1400 mm
- Tempo di risalita/discesa: 50/30 sec
- Centralina elettro-idraulica con serbatoio olio di 10 lt
- Tipo di olio idraulico: 46
- Dimensioni piano appoggio con bracci: 1000-1476 mm
- Spessore solaio in cemento armato: 300 mm (A RICHIESTA)
- Tipo di cemento: B25
- Peso netto/lordo: 478/500 kg

• Questo ponte elettroidraulico a forbice è idoneo per vetture e veicoli commerciali leggeri con peso totale non superiore a **2700 kg**

• Il sollevatore è dotato di un **blocco meccanico di sicurezza**

• Durante tutto il tempo di attesa il sollevatore si trova in posizione di sicurezza e si sblocca solo al momento della discesa da parte dell'operatore. Questa soluzione evita errori di disattivazione del sistema di sicurezza e **riduce a zero la possibilità di lasciare il veicolo incontrollato**

• Il sollevatore è dotato di **bracci regolabili** co ampia gamma di lavoro

**TECHNICAL FEATURES:**

- Movable electro-hydraulic lift
- Capacity: 2700 kg
- Motor power: 2.2 kw, 230V 1ph
- Lifting height: 180 ÷ 1400 mm
- Ascent / descent time: 50/30 sec
- Electro-hydraulic unit with 10 lt oil tank
- Type of hydraulic oil: 46
- Support surface with arms dimensions: 1000-1476 mm
- Thickness of reinforced concrete floor: 300 mm (OPTIONAL)
- Type of cement: B25
- Net / gross weight: 478/500 kg

• This electro-hydraulic scissor lift is suitable for cars and light commercial vehicles with a total weight not exceeding **2700 kg**

• The lift is equipped with a **mechanic safety lock** designed for the operator's safety

• During the entire lifetime of the lift, it is in the secured position and is released only for the time of lowering by the operator. This solution prevents deactivation by mistake of the security system and **reduces the possibility of uncontrolled leaving of the vehicle to zero**

• This lift is equipped with adjustable **load-bearing arms** with a wide range of work

2,7t



Cod. 05.087.07

€ 305,00

**CAVALLETTO MONTAGGIO/SMONTAGGIO PORTIERE****UNIVERSAL STAND FOR ASSEMBLING AND DISASSEMBLING CAR DOORS****SOPORTE UNIVERSAL PARA MONTAJE Y DESMONTAJE DE PUERTAS DE COCHE**

- Lunghezza: 580 mm
- Profondità: 540 mm
- Altezza porta min: 1000 mm
- Altezza porta max: 1650 mm
- Corsa di sollevamento: 200 ÷ 600 mm
- Peso: 23 kg

- Length: 580 mm
- Depth: 540 mm
- Min door height: 1000 mm
- Max door height: 1650 mm
- Lifting stroke: 200 ÷ 600 mm
- Weight: 23 kg

- Longitud: 580 mm
- Profundidad: 540 mm
- Altura de la puerta min: 1000 mm
- Altura máxima de la puerta: 1650 mm
- Carrera de elevación: 200 ÷ 600 mm
- Peso: 23 kilos



Cod. 05.088.148

€ 320,00

**CAVALLETTO UNIVERSALE PER VERNICIATURA CERCHIONI****UNIVERSAL SUPPORT FOR WHEEL RIM PAINTING****SOPORTE UNIVERSAL PARA PINTAR LLANTAS**

- Lunghezza: 1690 mm
- Profondità: 1160 mm
- Altezza min: 865 mm
- Peso: 44 kg

- Length: 1690 mm
- Depth: 1160 mm
- Min height: 865 mm
- Weight: 44 kg

- Longitud: 1690 mm
- Profundidad: 1160 mm
- Altura de la puerta min: 865 mm
- Peso: 44 kg

**3 SET EVA PER STRUMENTI ISOLATI PER I LAVORI SU VETTURE IBRIDE (CONFORME IEC 60900)**  
**3 EVA SETS FOR INSULATED TOOLS FOR SERVICE ON HYBRID CARS (ACCORDING TO IEC 60900)**  
**3 JUEGOS DE HERRAMIENTAS AISLADAS PARA EL MANTENIMIENTO EN COCHES HÍBRIDOS (SEGÚN IEC 60900)**

**HYBRID  
CARS**

Cod. 05.090.99

€ **480,00**

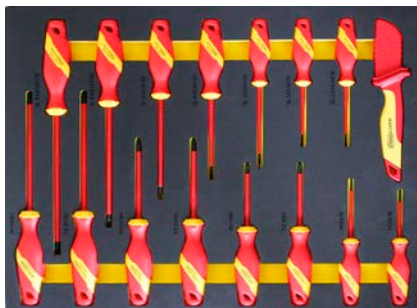
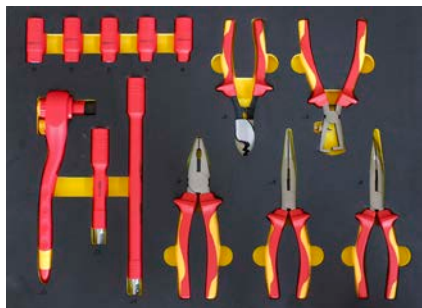

PROMO 2022/2

1	Insulated Combination Pliers, 200mm	
2	Insulated Wire Stripping Pliers, 160mm	
3	Insulated Flat Nose Pliers, 200mm	
4	Insulated High Leverage Long Snipe Nose Pliers, 200mm	
5	Insulated Cable Cutting Pliers, 160mm	
6	Insulated Slotted Screwdriver, 2.5*0.4*75mm	
7	Insulated Slotted Screwdriver 3*0.5*75mm	
8	Insulated Slotted Screwdriver 3*0.5*100mm	
9	Insulated Slotted Screwdriver 4*0.8*100mm	
10	Insulated Slotted Screwdriver 5.5*1*125mm	
11	Insulated Slotted Screwdriver 6.5*1.2*150mm	
12	Insulated Slotted Screwdriver 8.0*1.6*175mm	
13	Insulated Phillips Screwdriver PH0*75mm	
14	Insulated Phillips Screwdriver PH1*80mm	
15	Insulated Phillips Screwdriver PH2*100mm	
16	Insulated Phillips Screwdriver PH3*150mm	
17	Insulated Pozidriv Screwdriver PZ0*60mm	
18	Insulated Pozidriv Screwdriver PZ1*80mm	
19	Insulated Pozidriv Screwdriver PZ2*100mm	
20	Insulated Pozidriv Screwdriver PZ3*150mm	
21	VDE Insulated Cable Knife 190mm/208mm (52mm blade)	

22	1/2" Insulated Sockets 10mm	
23	1/2" Insulated Sockets 11mm	
24	1/2" Insulated Sockets 12mm	
25	1/2" Insulated Sockets 13mm	
26	1/2" Insulated Sockets 14mm	
27	1/2" Insulated Ratchet Wrench 250mm	
28	1/2" Insulated Extension Bar 125mm	
29	1/2" Insulated Extension Bar 250mm	
30	Insulated Ring Wrench 6mm	
31	Insulated Ring Wrench 7mm	
32	Insulated Ring Wrench 8mm	
33	Insulated Ring Wrench 9mm	
34	Insulated Ring Wrench 10mm	
35	Insulated Ring Wrench 11mm	
36	Insulated Ring Wrench 12mm	
37	Insulated Ring Wrench 13mm	
38	Insulated Ring Wrench 14mm	
39	Insulated Ring Wrench 15mm	
40	Insulated Ring Wrench 16mm	
41	Insulated Ring Wrench 17mm	
42	Insulated Ring Wrench 18mm	
43	Insulated Ring Wrench 19mm	

Cod. 05.088.141 € 306,00

VUOTO / EMPTY / VACIO



Cod. 05.090.99 € 480,00



3 EVA SET



+

=

€ 786,00

Cod. 03.036.01 € 1.141,00

**RECUPERATORE CARBURANTI (BENZINA/GASOLIO) 90 LT  
90 LT FUEL (PETROL/DIESEL) RECOVERY DEVICE  
RECUPERADOR DE COMBUSTIBLES (GASOLINA/GASÓLEO), 90 LT**

- Capacità: 90lt
- Serbatoio carrellato in acciaio inox
- Funzionamento con sistema Venturi (A)
- Aspira e scarica il carburante in pochi minuti
- Dispositivo per recupero vapori (B)
- Dimensioni: 530x530x1100mm
- Peso 28.3 kg
- Capacity: 90lt
- 90lt Stainlesssteel tank with trolley
- Functioning with Venturi system (A)
- It drains and discharges the fuel in a few minutes
- Device to recover vapours (B)
- Dimensions: 530x530x1100mm
- Weight: 28.3 kg
- Capacidad: 90lt
- Depósito de acero inoxidable 90lt con carro
- Funcionamiento con sistema Venturi (A)
- Drena y descarga el combustible en pocos minutos.
- Dispositivo para recuperar vapores (B)
- Dimensiones: 530x530x1100 mm
- Peso: 28,3 kg



Cod. 04.013.05 € 38,40

**TERMOMETRO DIGITALE A RAGGI INFRAROSSI  
con puntatore laser (-50°/+400°)**

**DIGITAL INFRARED THERMOMETER  
with laser pointer (-50°/+400°)**

**TERMÓMETRO DIGITAL DE RAYOS INFRARROJOS  
con puntador laser (-50°/+400°)**

- Misura della temperatura senza contatto
- Spegnimento automatico
- Grado di emissività regolabile 0,95 (fisso)
- Rapporto distanza-dimensioni: 12:1
- Data hold
- Non-contact temperature measurement
- Auto Power Off
- Adjustable emissivity: from 0,95 (fixed)
- Distance spot ratio: 12:1
- Data hold
- Medición de la temperatura sin contacto
- Apagado automático
- Grado de emisión regulable 0,95 (fijo)
- Relación distancia-dimensiones: 12:1
- Data hold



PROMO 2022/2



Cod. 05.092.01

€ 16,80



**SET 11 UTENSILI SMONTA-ACCESSORI**  
**KIT OF 11 TOOLS FOR DISASSEMBLING REMOVABLE ACCESSORIES**  
**KIT DE 11 HERRAMIENTAS PARA DESMONTAR LOS ACCESORIOS REMOVIBLES**

- SET SMONTATUTTO  
11 utensili in plastica molto resistente, consentono di togliere tutti gli accessori smontabili dal veicolo senza graffiare le parti relative e la vernice.
- UNIVERSAL DEMOUNTING SET  
11 high-resistant plastic devices that enable you to remove all the demountable accessories from the vehicle without scratching the parts and the paint.
- JUEGO DE HERRAMIENTAS DE DESMONTAJE  
11 dispositivos de plastico de alta resistencia que le permiten eliminar todos los accesorios desmontables desde el vehiculo sin rayar las partes y la pintura.

Cod. 05.087.10

€ 38,50



**CAVALLETTO APOGGIA CRISTALLI**

**SAW-HORSE FOR WINDOWS**

**CABALLETE PARA APODA CRISTALES**

Cod. 05.087.13

€ 96,00

**PEDANA IN ALLUMINIO**  
**ALUMINIUM PLATFORM**  
**PLATAFORMA DE ALUMINIO**

- per carrozzerie, officine meccaniche, artigiani, edilizia, manutentori
- for body parts workshops, mechanic workshops, maintenance technicians
- para chapistas, talleres mecanicos, tecnicos de mantenimiento



Portata:	Load range:	Rango de carga:	200kgs
Dimensioni:	Dimensions:	Dimensiones:	1016x410x585mm
Peso:	Weight:	Peso:	8,5 kgs

Cod. 05.087.02

€ 159,00

**CAVALLETTO ESTENSIBILE MULTIUSO**  
**EXTENSIBLE MULTI-PURPOSE SAWHORSE**  
**CABALLETE EXTENSIBLE MULTIUSO**



- Piani di lavoro rivestiti in gomma antiscivolo
- Regolazione in altezza (fino a 132cm), 2 ruote con freno
- Regolabile in apertura (da 22,5 cm chiuso a 138cm completamente aperto)
- Portata 100kg
- Ideale come supporto di appoggio per officine, carrozzerie, laboratori di assemblaggio in genere
- Nei momenti di non uso occupa uno spazio di 0,2m<sup>2</sup>
- Working surface covered with non slip rubber
- Adjustable height (up to 132cm), 2 wheels with brake
- Adjustable opening (from 22,5 cm closed to 138cm completely open)
- Capacity 100kg
- Ideal as a support for workshops, car body repairers' and assembling laboratories
- When closed it takes 0,2m<sup>2</sup>
- Tablero de trabajo con cobertura de caucho antideslizante
- Altura ajustable (hasta 132cm), 2 ruedas con freno
- Abertura ajustable (desde 22,5 cm cerrado hasta 138cm completamente abierto)
- Capacidad 100kg
- Ideal como soporte para talleres, chapistas, laboratorios de ensamblaje
- Cuando no se utiliza ocupa un espacio de 0,2m<sup>2</sup>

Cod. 05.008.01

€ 6,50



**VASSOIO MAGNETICO DOPPIO**  
**DOUBLE MAGNETIC PART DISH**  
**BANDEJA MAGNÉTICA DOBLE**

• 240x140 mm

Cod. 05.064.00

€ 84,00

**KIT SMONTAGGIO/MONTAGGIO PARABREZZA**

Il kit include: 2 coppie di ventose oscillanti, 2 coppie di maniglie tirafilo, 1 attrezzo inseritore filo, 1 cinghia a cricchetto, 1 matassa di filo a sezione quadra.

**KIT FOR MOUNTING AND DISMOUNTING WINDSCREENS**

The kit includes: 2 couples of swivelling vacuum cups, 2 couples of wire gripping handles, wire feeder tool, 1 ratchet, steel square wire.

**KIT PARA MONTAR Y DESMONTAR PARABRISAS**

El kit incluye: 2 pares de ventosas oscilantes, 2 pares de asas tirahilos, 1 herramienta para introducir el hilo, 1 correa con carraca, 1 madeja de hilo de sección cuadrada.



Cod. 05.013.03

€ 5,95



**COPERTURA PARAFANGO MAGNETICA**

Protegge la carrozzeria da graffi e urti accidentali. In panno e neoprene. Dimensioni: 110x40cm

**WORKSHOP WING COVER WITH MAGNETS**

It protects the car wing from scratches and accidental damage. Cloth and neoprene. Dimensions: 110x40cm

**CUBIERTA GUARDABARROS MAGNÉTICA**

Protege el guardabarros de arañazos y daños accidentales. Paño y neopreno. Dimensiones: 110x40cm

Cod. 05.090.22

€ 11,00

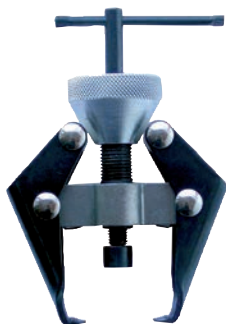

**ESTRATTORE PER TERMINALI BATTERIA**  
**E BRACCI TERGICRISTALLI**

**TWO LEG PULLER FOR BATTERY TERMINALS**  
**AND WIDESCREEEN WIPE ARMS**

**TIRADOR A DOS PIERNAS PARA TERMINALES**  
**DE LA BATERÍA Y DEL LIMPIAPARABRISA**

12V

Cod. 04.042.00

€ 20,30

24V

Cod. 04.042.01

€ 20,30



**SOPPRESSORE DI IMPULSI**  
**IMPULSE SUPPRESSOR**  
**SUPRESOR DE IMPULSOS**

Protegge gli impianti di iniezione e accensione elettronica da picchi di tensione durante i lavori di saldatura in carrozzeria: si monta tra + e - della batteria.

It protects electronic injection and ignition from voltage peaks during welding operations in workshops. It has to be installed between the + and - of the battery.

Protege la ignición y la inyección electrónica de picos de tensión durante las operaciones de soldadura en talleres. Tiene que ser instalado entre el + y - de la batería.

Cod. 05.062.04

€ 14,00

**SET DI 4PCS DI PINZE PER MICRO SALDATURA**

**SET OF 4PCS MICRO WELDING CLAMPS**

**JUEGO DE 4PCS ABRAZADERAS PARA MICRO-SOLDADURA**



Cod. 05.062.03

€ 13,90

**PINZA CON TESTA ORIENTABILE PER ESTRAZIONE TAPPI IN PLASTICA**  
**CLAMP WITH ADJUSTABLE HEAD FOR EXTRACTING PLASTIC CAPS**  
**ABRAZADERA CON CABEZA AJUSTABLE PARA LA EXTRACCIÓN**  
**DE TAPONES DE PLÁSTICO**





Cod. 05.090.85

€ 18,00

**SPESIMETRI PER CARROZZERIA**  
a 10 lame con ventosa di fissaggio (2 pz)  
per posizionamento cristalli

**10-BLADE BODY THICKNESS GAUGES**  
with fixing suction cup (2 pcs) for windows positioning

**MEDIDORES DE ESPESOR DE CARROCERIA**  
de 10 cuchillas con ventosa de fijación (2 piezas)  
para el posicionamiento de cristales



Cod. 05.091.02

€ 92,00

**SEGHETTO PNEUMATICO**  
**AIR CAR BODY SAW**  
**SIERRA DE AIRE**

- Velocità: 9.000 rpm/min
- Lunghezza: 235 mm
- Peso: 770 g
- Consumo aria: 120 L/min
- Pressione aria: 6,3 bar
- Livello rumore: 72,0 dB (a)
- Accelerazione: 26,0 m/ s<sup>2</sup>
- Max. capacità taglio: 1,2 mm
- Free speed: 9.000 rpm/min
- Length: 235 mm
- Weight: 770 g
- Air consumption: 120 L/minute
- Air pressure: 6,3 bar
- Noise level: 72,0 dB (a)
- Acceleration: 26,0 m/ s<sup>2</sup>
- Max. cutting capacity: 1,2 mm
- Velocidad libre: 9.000 rpm/min
- Longitud: 235 mm
- Peso: 770 g
- Consumo de aire: 120 l/min
- Presión del aire: 6,3 bar
- Nivel de ruido: 72,0 dB (a)
- Aceleración: 26,0 m / s<sup>2</sup>
- Max. capacidad de corte: 1,2 mm



Cod. 05.074.05

€ 120,00

**MISURATORE SPESSORE VERNICI**  
**DIGITAL PAINT THICKNESS INDICATOR**  
**INDICADOR DIGITAL ESPESOR DE PINTURA**

- Utilizzabile su superfici in acciaio e alluminio
- Campo di misura: 0-5000 µm
- Precisione: +/- 10 mm
- Riconoscimento automatico del supporto
- Sonda esterna con tastatore adatta anche a superfici irregolari
- 2 kit di calibrazione
- Fabbricato in UE
- It can be used on aluminum and steel surfaces
- Measuring range: 0-5000 µm
- Precision: +/- 10mm
- Automatic detection of the material
- External probe, it can be used on irregular surfaces
- 2 calibration kits
- Made in EU
- Se puede utilizar sobre superficies de aluminio y acero
- Intervalo de medida: 0-5000 µm
- Precisión: +/- 10 mm
- Detección automática del material
- Sonda externa, se puede utilizar en superficies irregulares
- 2 kit de calibración
- Fabricado en la UE

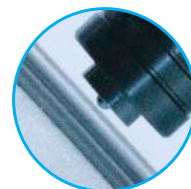

Cod. 05.090.25

€ 31,50

**KIT SMONTAGGIO AIRBAG (12 PZ.)**  
**12 PCS. AIR BAG REMOVAL TOOL SET AIRBAGS**  
**KIT PARA DESMONTAR EL AIRBAG (12 PZAS.)**



Cod. 05.066.02

€ 56,00

2000W



**SET SVERNICIATORE**  
**PAINT REMOVER SET**  
**SET PARA ELIMINACION DE PINTURA**

- 2 velocità / 2 speeds / 2 velocidades de: 300 ° C - 600 ° C
- Flusso d'aria / Air flow / Flujo de aire: 500l/min - 650l/min
- Potenza / Power / Alimentación: 2 kW 230V 50Hz
- Imballo / Packaging / Embalaje: 10 Kg



# EXTRACTOR 2000

Cod. 03.032.01

€ 770,00

**ASPIRATORE GAS CARRELLATO PER AUTO, FURGONI, CAMION**  
**WHEELED GAS ASPIRATOR FOR CARS, VANS, TRUCKS**

## CARATTERISTICHE TECNICHE

- Capacità di aspirazione: 2000 mc/h
- Potenza del motore: 1,1 kw
- Altezza massima (dal centro della bocchetta): 650 mm
- Altezza minima (dal centro della bocchetta): 350 mm
- Ø Bocchetta: 235 mm
- Ø Tubo gas: 152 mm
- Lunghezza del tubo flessibile: 10 mt
- Temperatura max. del tubo flessibile: 150°

## TECHNICAL FEATURES

- Aspiration capacity: 2000 mc/h
- Engine Power: 1,1 kw
- Maximum Height (from the center of the nozzle): 650 mm
- Minimum Height (from the center of the nozzle): 350 mm
- Ø Nozzle: 235 mm
- Ø Expulsion gas hose: 152 mm
- Length of Expulsion gas hose: 10 mt
- Max t° of expulsion gas hose: 150°



**Bocchetta per auto/furgoni/camion**  
Cars/ vans / trucks nozzle



**Tubazione di uscita 10 m/Ø 152mm**  
10 m / Ø 152mm Outlet hose

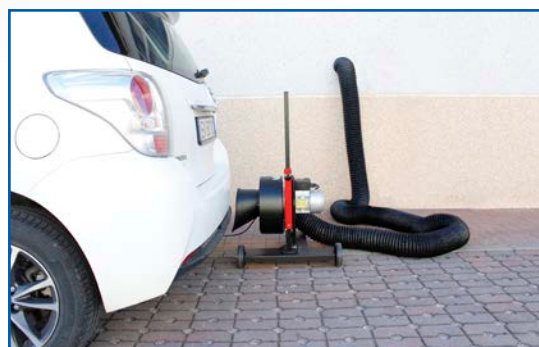

Cod. 05.066.06PRO

€ 449,00

# INDUCTOR BASIC 1 KW

IN VALIGETTA DI TRASPORTO IN ALLUMINIO • CON 5 SPIRALI INCLUSI  
IN ALUMINUM CASE • WITH 5 HEATING COILS INCLUDED

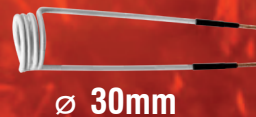

LO SAPEVI CHE È PROIBITO IL RISCALDAMENTO CON FIAMME LIBERE?

DID YOU KNOW THAT HEATING WITH OPEN FLAMES IS PROHIBITED?



Riscaldamento ad induzione è un metodo senza contatto che può essere usato per riscaldare i metalli. Il riscaldatore ad induzione crea un campo magnetico alternato che genera correnti indotte all'interno del materiale. Sono queste correnti indotte che generano calore.

L'assenza di fiamme libere rende il lavoro più sicuro assicurando allo stesso tempo sicurezza e risparmio economico. Permette di lavorare anche vicino a parti sensibili al calore.





Induction heating is a contactless method that can be used to heat metals. The induction heater creates an alternating magnetic field that generates currents induced within the material. They are these induced currents that generate heat.

The absence of open flames makes the work safer while ensuring economic safety and savings. Allows you to work even close to parts sensitive to heat.



INDUCTION

INDUTTORI DI CALORE  
HEATING INDUCTORS

 <b>MADE IN ITALY</b>  <b>DATI TECNICI</b> <b>TECHNICAL FEATURES</b>				
	<b>Hi 3.7</b>	<b>Hi 5.5</b>	<b>Hi 13</b>	<b>Hi 18</b>
Modello / Model	<b>Cod. 05.066.11</b>	<b>Cod. 05.066.13</b>	<b>Cod. 05.066.27</b>	<b>Cod. 05.066.28</b>
Codice / Code	<b>3.7 Kw 16A</b>	<b>5 Kw 16A</b>	<b>13 Kw 16A</b>	<b>18 Kw 32A</b>
Max potenza / Max. power	230V single phase	400V 3ph	400V 3ph	400V 3ph
Alimentazione / Power supply	15 ÷ 30 kHz	15 ÷ 30 kHz	15 ÷ 30 kHz	15 ÷ 30 kHz
Frequenza regolabile (kHz) Frequency range (kHz)	15'	30'	45'	60'
Duty cycle	4 mt	4 mt	4 mt	4 mt
Cavo induttore Inductor cable length	9 mt	9 mt	9 mt	9 mt
Cavo alimentazione Power supply cable length	20 lt	20 lt	20 lt	20 lt
Capacità serbatoio Tank capacity	√	√	√	√
Raffreddamento a liquido Cooling system	√	√	√	√
Tastiera / Keyboard	IEC 60309	IEC 60309	IEC 60309	IEC 60309
Connessione elettrica Electrical connection	80 x 80 x 115	80 x 80 x 118	80 x 83 x 135	80 x 83 x 135
Dimensioni / Dimensions, cm	50 kg	67 kg	120 kg	130 kg
Peso / Weight, kg	<b>APPLICAZIONE / APPLICATION</b>			
Carrozzerie / Car Body Shops	x	—	—	—
Gommisti / Tyre Shops	xxx	—	—	—
Meccanica auto / Car Mechanics	xxx	xx	—	—
Agri	xx	xxx	xxx	x
Autocarri/movimento terra Trucks/earth moving vehicles	—	x	xxx	xxx
Manutenzione/Industria/Nautica Trucks/earth moving vehicles	—	—	xxx	xxx
Prezzo promo / Promo price	a richiesta / on request	a richiesta / on request	a richiesta / on request	a richiesta / on request

ACCESSORI A RICHIESTA / OPTIONAL ACCESSORIES

<b>Hi 3.7 / Hi 5.5</b>		<b>Hi 13</b>		<b>Hi 18</b>
 <b>Cod. 05.066.14</b> Puntale laterale Lateral operating tool		 <b>Cod. 05.066.19</b> Puntale laterale Lateral operating tool		<b>Cod. 05.066.28.R1</b>
 <b>Cod. 05.066.15</b> Puntale verticale Vertical operating tool		 <b>Cod. 05.066.20</b> Puntale verticale Vertical operating tool		<b>Cod. 05.066.28.R2</b>
 <b>Cod. 05.066.16</b> Ferrite per puntale laterale Ferrite for lateral operating tool		 <b>Cod. 05.066.21</b> Ferrite per puntale laterale Ferrite for lateral operating tool		<b>Cod. 05.066.28.R3</b>
 <b>Cod. 05.066.17</b> Ferrite per puntale verticale Ferrite for vertical operating tool		 <b>Cod. 05.066.22</b> Ferrite per puntale verticale Ferrite for vertical operating tool		<b>Cod. 05.066.28.R4</b>



**CARATTERISTICHE TECNICHE:**

- Le normative rispettate dal prodotto: IEC61672, ISO-9001, CE, IEC1010
- Misuratore del livello sonoro di classe 1
- Diametro esterno microfono standard 0.5" Costanti di tempo Slow e Fast
- Funzionamento facile ed innovativo,
- per la configurazione del software non è necessario il computer, il fonometro è dotato di serie di una memory card SD per il registro dei dati
- (anno /mese /giorno /ora /minuti /secondi) che si introduce nel lettore del computer per la lettura in formato Excel, l'utente può effettuare le ulteriori analisi grafici.

**TECHNICAL FEATURES:**

- Frequency and time weighting Class 1
- weighting networks comply with standards IEC61672, ISO-9001, CE, IEC1010

0.5" standard microphone head  
Memory function to store the Max. & Min. value  
Hold and Peak Hold functions

Innovation and easy operation, computer is not need to setup extra software, after execute data logger, just take away the SD card from the meter and plug in the SD card into the computer, it can download all the measured values with the time information (year/month/date/hour/minute/second) to the Excel directly, then user can make the further data or graphic analysis by themselves

Measurement range: 30 - 130 dB  
Resolution: 0.1 dB  
Function: dB (A & C frequency weighting Time weighting (Fast,Slow), Peak hold, Data hold, Record (Max., Min.)  
Calibration VR: Build in external calibration VR, easy to calibrate on 94 dB level by screw driver. Calibrated via external SOUND CALIBRATOR (optional)  
Weight: 489 g/1,08 LB  
Dimension: 245 x 68 x 45 mm  
Accessories Included: instruction manual, hard carrying case, CA-06  
Optional accessories: Sound wind shield ball sound calibrator (94 dB)  
SD Card (2GB)  
USB cable, USB-01  
Data acquisition software, SW-U801-WIN.

Cod. 04.019.02

€ 576,<sup>00</sup>

**FONOMETRO DIGITALE CLASSE 1**

con SD card e uscita USB

**DIGITAL SOUND LEVEL METER**

with SD Card real time data logger

**SONÓMETRO DIGITAL**

tarjeta SD registradora de datos en tiempo real

Campo di misura: 30 - 130 dB  
Risoluzione: 0.1 dB  
Funzioni: dB (ponderazione A e C, costanti di tempo Fast e Slow, Hold Peak, Data Hold, Record (max, min)  
Taratura VR: taratura VR esterna integrata, facile da calibrare a 94 dB con il cacciavite. Taratura tramite calibratore acustico esterno (a richiesta)  
Peso: 489 g / 1,08 LB  
Dimensioni: 245 x 68 x 45 mm  
Accessori inclusi: manuale d'uso, valigetta rigida di trasporto, CA-06  
Accessori opzionali: Calibratore del livello sonoro (94 dB)  
Cuffia antivento  
SD card (2 GB)  
Cavo USB, USB-01  
Software di acquisizione dati, SW-U801-WIN

**CARACTERÍSTICAS TÉCNICAS:**

Frecuencia y ponderación temporal Clase 1  
Las redes son compatibles con las normas IEC61672, ISO-9001, CE, IEC1010  
Cabeza 0.5" de micrófono  
Función de memoria para memorizar el valor Max y Min.  
Funcion de "Pico" y "Mantenimiento Pico"  
Innovación y operatividad fácil, el ordenador no necesita de un software adicional, después de ejecutar el registro de datos, simplemente quite la tarjeta SD del medidor y la conecte al ordenador, se pueden descargar directamente todos los valores de medición con la información del tiempo (Año /mes /dia /hora /minuto /segundo) en Excel, entonces el usuario puede procesar en datos o hacer un análisis gráfico por sí mismo

Rango de medición: 30 - 130 dB  
Resolución: 0,1 dB  
Función: dB (A & C ponderación de frecuencia y tiempo (rápido, lento) Retención de pico, Retención de datos, Registro (Máx., Min.)  
Calibración VR: calibración externa en VR ya incluida, fácil calibración del nivel en 94 dB por destornillador. Calibrado mediante calibrador de sonido externo (opcional)  
Peso: 489 g / 1,08 LB  
Dimensiones: 245 x 68 x 45 mm  
Accesorios incluidos: Manual de instrucciones estuche rígido CA-06  
Accesorios opcionales: Bola quitavientos de sonido Calibrador acústico (94 dB)  
Tarjeta SD (2GB)  
Cable USB, USB-01  
Software de adquisición de datos, SW-U801-WIN



Cod. 04.018.05

€ 321,<sup>00</sup>

**FONOMETRO CLASSE 2 CON RS232 SOUND**

LEVEL METER CLASS 2 WITH RS232

FONÓMETRO CLASE 2 CON RS232

Cod. 04.018.06

€ 65,<sup>00</sup>

**CAVETTO UPCB-2 PER FONOMETRO SL 4012, INCL. SOFTWARE  
UPCB-2 CABLE FOR THE SOUND LEVEL METER SL 4012, INCL. SOFTWARE  
CABLE UPCB-2 PARA FONÓMETRO SL 4012 CON SOFTWARE INCLUIDO**

Cod. 04.014.02

€ 349,00

**TERMO CAMERA A RAGGI INFRAROSSI**  
**INFRARED THERMAL IMAGING CAMERA**  
**CÁMARA DE IMÁGENES TÉRMICAS INFRARROJOS**



Foto indicativa  
Indicative picture

- Display: 2.4"
- Risoluzione di immagine: 0.3 mega pixel
- Sensibilità termica: 0.5°C
- Range di temperatura: -20°/+400°C
- Memorizzazione immagini: scheda SD (4G)
- Tipo di batteria: 4\*1.5 V AA (non incluse)
- Tempo di spegnimento automatico: 12 min.
- Dimensioni: 212x90x62mm
- Peso: 231 gr
- Dimensioni confezione: 270x190x110mm

- Display: 2.4"
- Image resolution: 0.3 mega pixels
- Thermal sensitivity: 0.5°C
- Temperature range: -20°/+400°C
- Image storage: SD card (4G)
- Battery type: 4\*1.5V AA (not included)
- Automatic switch-off time: 12 minutes
- Dimensions: 212x90x62mm
- Weight: 231 gr
- Package size: 270x190x110mm

- Pantalla: 2.4"
- Resolución de la imagen: 0.3 megapíxeles
- Sensibilidad térmica: 0.5°C
- Rango de temperatura: -20°/+400°C
- Almacenamiento de imágenes: tarjeta SD (4G)
- Tipo de batería: 4\*1.5V AA (no incluidas)
- Tiempo de apagado automático: 12 minutos
- Dimensiones: 212x90x62 mm
- Peso: 231 gr
- Tamaño del paquete: 270x190x110mm

**Campi di utilizzo • Fields of use • Campos de uso**



Car engine maintenance

Manutenzione del motore dell'automobile  
Car engine maintenance  
Mantenimiento del motor del coche



Air conditioning maintenance

Manutenzione dell'impianto aria condizionata  
Air conditioning maintenance  
Mantenimiento del sistema de aire acondicionado



Transformer line maintenance

Manutenzione della linea del trasformatore  
Transformer line maintenance  
Mantenimiento de la línea del transformador

Cod. 04.052.05

€ 42,00

FINE SERIE  
SELL OUT

**TERMOMETRO DIGITALE DIFFERENZIALE**  
(per refrigerazione e condizionamento)

**DIGITAL DIFFERENTIAL THERMOMETER**  
(for refrigeration and air conditioning)

**TERMÓMETRO DIGITAL DIFERENCIAL**  
(para refrigeración y aire acondicionado)

- Antiurto
- Compatibile con sonde a termocoppia di tipo K
- Range: -50°/+1350 °C
- Completo di custodia, batteria, 2 sonde a filo
- A richiesta sonda per:
  - aria 04.052.02
  - contatto 04.052.03
- Shock-resistant
- Compatible with K-type thermocouple probe
- Range: -50°/+1350 °C
- With case, battery and 2 wire-type probes included
- On request probe for:
  - air 04.052.02
  - contact 04.052.03

- Antichoque
- Compatible con sonda termopar de tipo K
- Intervalo: -50°/+1350 °C
- Completo con estuche, batería, 2 sondas de hilo
- Bajo pedido sonda para:
  - aire 04.052.02
  - contacto 04.052.03

Cod. 04.052.02

€ 17,50



Cod. 04.052.03

€ 21,00



Cod. 04.052.04

€ 23,10



Pinza per tubi con termocoppia per misurazione temperatura  
Pipe wrench with thermocouple for temperature measurement  
Llave para tubos con termopar para mediciones de temperatura  
-50/+200°C

Cod. 04.052.07

€ 36,<sup>00</sup>**RILEVATORE DIGITALE**

cercametalli e rilevatore di cavi elettrici AC

**DIGITAL FINDER**

for metal, ac wiring, wood

**DETECTOR DIGITAL**

de metales y detector de cables electricos AC

**CARATTERISTICHE TECNICHE:**

- Display LCD con indicatore acustico
- Individua rivestimenti di legno fino a 38mm
- Individua tubi in metallo fino a 76mm
- Individua cavi elettrici (AC) fino a 76mm
- Autocalibrazione
- Alimentazione: 1 batteria 9V (non fornita)
- Confezione in blister

**TECHNICAL FEATURES::**

- LCD display and audio indicator
- Wood detection up to 38mm
- Metal pipes detection up to 76mm
- AC live wires detection up to 76mm
- Auto calibration
- Power supply: 6F 22 9V battery (not supplied)
- Blister packaging

Cod. 01.000.258

€ 156,<sup>00</sup>**CERCAFUGHE PER GAS COMBUSTIBILI**  
**LEAK DETECTOR FOR FLAMMABLE GASES****IL CERCAFUGHE GAS COMBUSTIBILE**

è progettato come un rilevatore di gas combustibile ad alte prestazioni. L'unità è costruita con sensori e microprocessori a gas semiconduttori di nuova concezione per fornire un'affidabile elaborazione del segnale digitale. Il livello di sensibilità della perdita regolabile e 7 indicatori visivi a LED offrono agli utenti anche la facilità e la convenienza delle operazioni.

**CARATTERISTICHE TECNICHE:**

- Controllo a microprocessore con elaborazione avanzata del segnale digitale
- Display a colori
- Selettore di sensibilità perdite alto/basso
- Indicazione di batteria scarica
- Sensore di gas a semiconduttore
- Rilevazione di benzina, propano, gas naturale, olio combustibile, ecc
- Sonda inossidabile flessibile da 39 cm
- Fonte di perdite di riferimento inclusa
- Ripristino della concentrazione ambientale

**Specifiche:**

- Gas misurabili: benzina, propano, gas naturale, olio combustibile, ecc
- Sensibilità: variabile, a partire da 5ppm (benzina)
- Metodo di allarme: allarme acustico, indicatore a LED
- Lunghezza del tubo di rilevamento: 390mm
- Tempo di riscaldamento: 90 sec
- Batteria: 1,5 V AA x 4
- Dimensioni: 173 x 66 x 56 mm
- Peso: 400gr

The **COMBUSTIBLE GAS LEAK DETECTOR** is designed as a high performance flammable gas detector. The unit is built with newly developed semiconductor gases sensors and microprocessors to provide reliable digital signal processing. The adjustable level of leak sensitivity and 7 LED visual indicators also provide for easy and convenient operations for the users.

**TECHNICAL FEATURES:**

- Control por microprocesador con procesamiento avanzado de señal digital.
- Pantalla a color
- Selector de sensibilidad de fuga alta/baja
- Indicación de batería baja
- Sensor de gas semiconductor
- Detección de gasolina, propano, gas natural, fuel oil, etc.
- Sonda flexible de acero inoxidable de 39cm
- Referencia sobre la fuente de fuga incluida
- Restauración de la concentración ambiental

**Specifications:**

- Gases detectables: gasolina, propano, gas natural, fuel oil, etc.
- Sensibilidad: variable, a partir de 5ppm (gasolina)
- Método de alarma: alarma acústica, indicador LED
- Longitud del tubo de detección: 390mm
- Tiempo de calentamiento: 90 seg.
- Batería: 1.5V AA x 4
- Dimensiones: 173x66x56 mm.
- Peso: 400gr



Cod. 04.051.00

€ 46,00

**REFRATTOMETRO MULTIFUNZIONI  
MULTIFUNCTION REFRACTOMETER  
RÉFRACTOMÈTRE MULTIFONCTIONS**

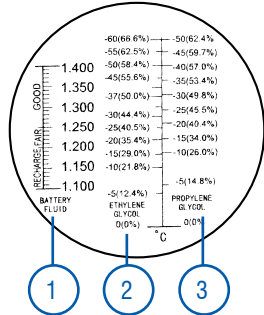

Uno strumento professionale per il controllo di:

- densità dell'acido della batteria
- punto di congelamento del liquido refrigerante del motore
- punto di congelamento del liquido lavavetri

A professional instrument to test:

- Density of acid batteries
- Freezing point of windsceen liquid
- Freezing point of refrigerant liquid of motor

Un instrumento profesional para controlar:

- densidad del ácido de la batería
- punto de congelación del líquido refrigerante del motor
- punto de congelación del líquido lavaparbrisas

1

- Acido Batteria
- Battery acid
- Ácido de las baterías

2

- Liquido Antigelo
- Antifreezing liquid
- Líquido anticongelante

3

- Liquido Lavavetri
- Freezing point of windscreen liquid
- Líquido lavaparbrisas

Cod. 04.051.01

€ 52,00

**REFRATTOMETRO PER UREA  
REFRACTOMETER FOR UREA  
REFRACTOMETRE POUR UREE**

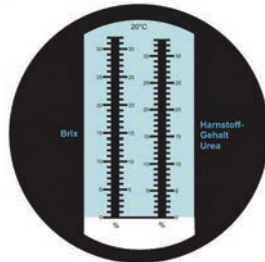

Permette di rilevare la concentrazione dell'urea nei serbatoi di autocarri dotati di dispositivo antinquinamento (AD BLUE)

- 2 scale 0-32%
- Brix graduation 0,2%,
- 0-33% urea 0,2%
- Compensazione automatica della temperatura

It enables to assess the urea concentration in the tanks of the trucks equipped with an anti-pollution device (AD BLUE).

- 2 scales 0-32%
- Brix graduation 0,2%,
- 0-33% urea 0,2%
- Automatic compensation of the temperature

Permite detectar la concentración de urea en los tanques de los camiones equipado con un dispositivo anticontaminación (AD BLUE).

- 2 escalas 0-32%
- Brix graduation 0,2%,
- 0-33% urea 0,2%
- Compensación automática de la temperatura



Cod. 04.051.02NEW

€ 239,00

**REFRATTOMETRO DIGITALE PER AD BLUE (UREA)  
DIGITAL REFRACTOMETER FOR AD BLUE (UREA)  
REFRACTOMETRE DIGITAL POUR AD BLUE (UREA)**

- misura gradi brix
- misura temperatura (°C/F)
- zero setting
- auto power off
- measure of brix gradutaion
- temperature measure (°C/F)
- zero setting
- auto power off
- medición grados brix
- medición temperatura
- ajuste cero)
- autoapagaminento

PROMO 2022/2

Cod. 01.000.260

€ 548,00

**GENERATORE DI FUMO PER INDIVIDUAZIONE PERDITE**  
**SMOKE LEAK DETECTOR**  
**DETECTOR DE FUGAS POR HUMO**

**CARATTERISTICHE TECNICHE:**

- Risparmio di tempo e maggiore efficienza per trovare le perdite in qualunque tipo di circuito clima (ad esempio impianti di refrigerazione), circuito aria, turbo, marmitte catalizzatori, filtri antiparticolato, testate motore
- Ampia dotazione di adattatori (tappi fissi e universali con pompa)
- Alimentazione: 12V da batteria con pinze
- Flusso d'aria: 6l/min
- Alimentazione d'aria incorporata
- 2 flaconi di prodotto

**Specifiche:**

1. Gancio per una facile movimentazione
2. Misuratore di tenuta visiva per il rilevamento rapido di perdite
3. Manometro incorporato nel circuito chiuso
4. Regolatore di flusso di uscita fumi
5. Interruttore di comando laterale, consente di tagliare la fornitura riempita a metà
6. Sistema multi-adattatore per adattarsi a tutti i tipi di fori
7. Dimensioni: 275 x 220 x 235 mm
8. Peso: 5 kg

**TECHNICAL FEATURES:**

- Time saving and greater efficiency to find leaks in any type of air-conditioning circuit (e.g. refrigeration systems), air circuit, turbo, catalysts, particle filters, engine heads
- Wide range of adapters (fixed and universal plugs with pump)
- Power supply: 12V from battery with clamps
- Air flow: 6l/min
- Built-in air supply
- 2 bottles of product

**Specifications:**

1. Hook for easy handling
2. Visual seal gauge for rapid leak detection
3. Pressure gauge built into the closed circuit
4. Smoke outlet flow regulator
5. Multi-adapter system to adapt to all types of holes
6. Side control switch, allows you to cut the half-filled supply
7. Dimensions: 275 x 220 x 235 mm
8. Weight: 5kgs

**CARACTERÍSTICAS TÉCNICAS:**

- Ahorro de tiempo y mayor eficiencia para encontrar fugas en cualquier tipo de circuito de aire acondicionado (p. ej., sistemas de refrigeración), circuito de aire, turbo, catalizadores, filtros de partículas, cabezas de motores
- Amplia gama de adaptadores (enchufes fijos y universales con bomba)
- Alimentación: 12V de batería con pinzas
- Flujo de aire: 6lt/min
- Suministro de aire incorporado
- 2 botellas de producto

**Especificaciones:**

1. Colgador de sujeción para un fácil manejo
2. Medidor de estanqueidad visual para detección rápida de pérdida
3. Medidor de presión en el circuito cerrado incorporado
4. Regulador de flujo de salida de humo
5. Sistema multi-adaptador para encajar en todo tipo de orificios
6. Interruptor de funcionamiento lateral, permite cortar el suministro a medio relleno
7. Dimensiones: 275 x 220 x 235 mm.
8. Peso: 5 kg

Cod. 01.000.261

€ 10,00

**PRODOTTO FUMIGANTE (500ML)**  
**MACHINE OIL (500ML)**  
**BOTELLA DE ACEITE (500ML)**







## ACCESSORI AUTO/CASA CAR/HOME ACCESSORIES

Cod. 05.073.29

€ 21,00

**LAMPADA FRONTALE** con batterie ricaricabili a ioni di litio  
**FRONT LAMP** with rechargeable lithium ion batteries



**DATI TECNICI:**

- 5W di potenza lampada frontale
- 3W di potenza luce posteriore
- 4 modalità di regolazione: lampada frontale (100%, 50%, 25%, OFF)
- Autonomia: 100% 2,5-3h; 50% 5-7h; 25% > 10h

**Principali applicazioni**

- Settore "bike"
- Settore trekking e climbing
- Cantieristica in genere
- Protezione civile
- Antinfortunistica

**TECHNICAL FEATURES:**

- 5W of power - front lamp
- 3W of power - rear light
- 4 adjustment modes: front lamp (100%, 50%, 25%, OFF)
- Autonomy: 100% 2.5-3h; 50% 5-7h; 25% > 10h

**Principali applicazioni**

- Bike sector
- Trekking and climbing sector
- Building industry in general
- Civil protection
- Accident prevention

Cod. 05.073.28

€ 17,90

**LAMPADA A LUCE SOLARE DA PARETE**, con sensore di movimento  
**SUNLIGHT LAMP WALL MOUNTED** with motion sensor



**DATI TECNICI:**

- Pannello solare da 5,5V/0,6W/ Efficienza 17%
- Batteria al litio 3,7V/1800mAh
- Rileva presenza di persone da 3 a 6mt
- Luminosità: 450 lumen
- Potenza: COB LED 10W
- Grado di isolamento: IP65
- Dimensioni: 153x105x49mm
- Peso: 237gr

**TECHNICAL FEATURES:**

- Solar panel 5.5V / 0.6W / 17% efficiency
- 3.7V / 1800mAh lithium battery
- It detects the presence of people from 3 to 6mt
- Brightness: 450 lumens
- Power: COB LED 10W
- Degree of insulation: IP65
- Dimensions: 153x105x49mm
- Weight: 237gr

Cod. 05.073.46

€ 12,50

**SFERA DI LUCE CON MAGNETE**  
**MAGNETIC LIGHT SPHERE**

250  
LUMEN



3 x AAA 1,5V  
minibatterie incl.



**DATI TECNICI:**

- Sfera magnetica orientabile a 360°
- 3 posizioni:  
luce centrale, luce totale, spenta
- Luminosità: 250 lumen
- Alimentazione: 3 x batterie 1,5V stilo (non incluse)

**TECHNICAL FEATURES:**

- 360° adjustable magnetic sphere
- 3 positions:  
central light, total light, off
- Brightness: 250 lumen
- Power supply: 3 x 1,5V stylus batteries (not included)

ARREDO PER OFFICINA • WORKSHOP FURNITURE • MUEBLES DE TALLER

**NEW!**

Cod. 05.088.142

€ 1.369,00

SET DI 107 UTENSILI INCLUSO  
SET OF 107 TOOLS INCLUDED

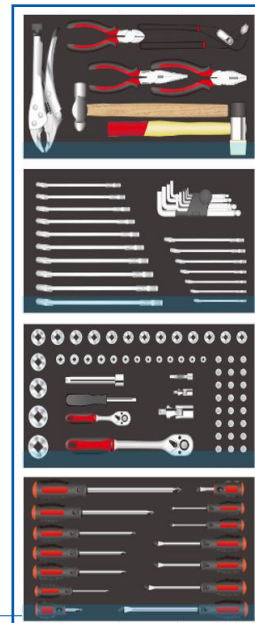

Disponibile solo in colore rosso-nero  
in black-red color available only

- |  |   |
|--|---|
| <ol style="list-style-type: none"> <li>1. Armadio a due porte, 3 ripiani, con 4 piedini regolabili</li> <li>2. Carrello estraibile con 4 cassetti, completo di 4 eva tools con 107 utensili (pagina 2)</li> <li>3. Carrello estraibile con 1 cassetto e 2 sportelli</li> <li>4. Piano in legno multistrato, tavolo con 4 piedini regolabili</li> <li>5. 6 pannelli forati portautensili</li> <li>6. 2 sportelli con anta apribile</li> <li>7. 2 ripiani porta oggetti</li> </ol> | <ol style="list-style-type: none"> <li>1. Two-door cabinet , 3 shelves, 4 feet adjustable in height</li> <li>2. 4 drawers trolley with 107 tools on 4 eva supports included (page 2)</li> <li>3. 2 doors trolley with 1 drawer</li> <li>4. Plywood workbench, 4 feet adjustable in height</li> <li>5. 6 perforated tool panels</li> <li>6. 2 wall cabinets with door</li> <li>7. 2 shelves</li> </ol> |
|--|---|

**Dimensioni / dimensions:**

1. 760x495x1960 (2056,5 with foot) mm
2. 616,5x330,3x800,4 mm
3. 616,5x330,3x800,4 mm
4. 1600x500x826,5 (863 with foot) mm
5. 398x19,5x600 mm
6. 400x198x600 mm
7. 798x20x178 mm

**1 PALLET**

525 x 790 x 2090mm  
Net/gross: 124/141 kg

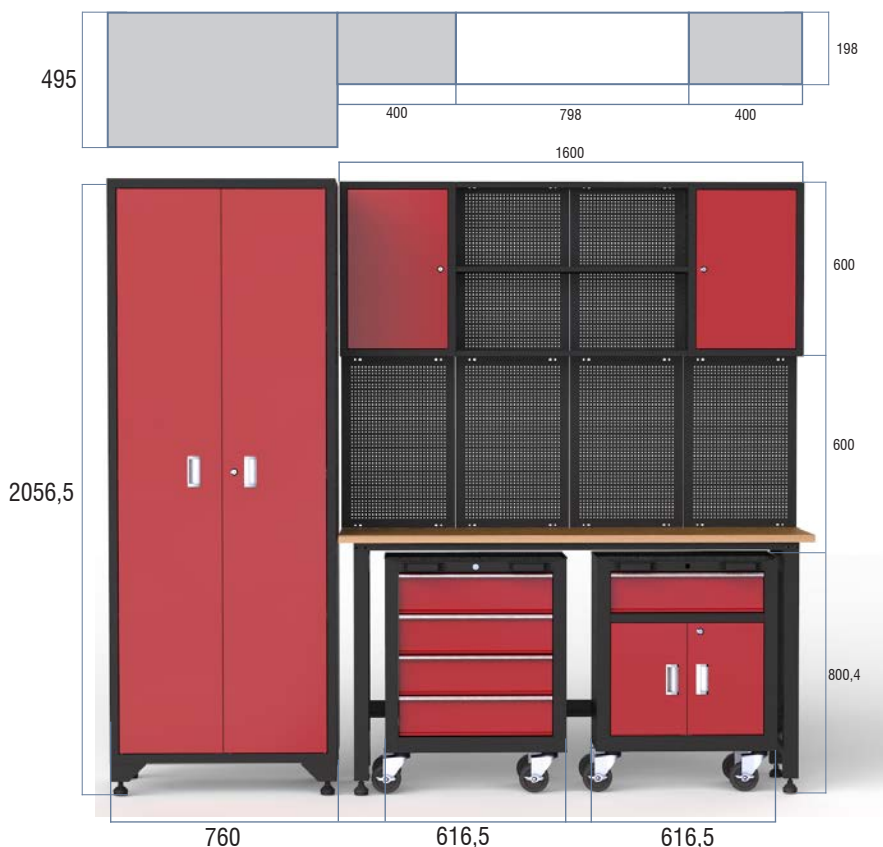

PROMO 2022/2

SET DI 107 UTENISLI CON SUPPORTI IN GOMMA INCLUSI NEL KIT 05.088.142  
 SET OF 107 TOOLS WITH RUBBER SUPPORTS INCLUDED IN KIT 05.088.142

NEW!

Cod. 05.088.142

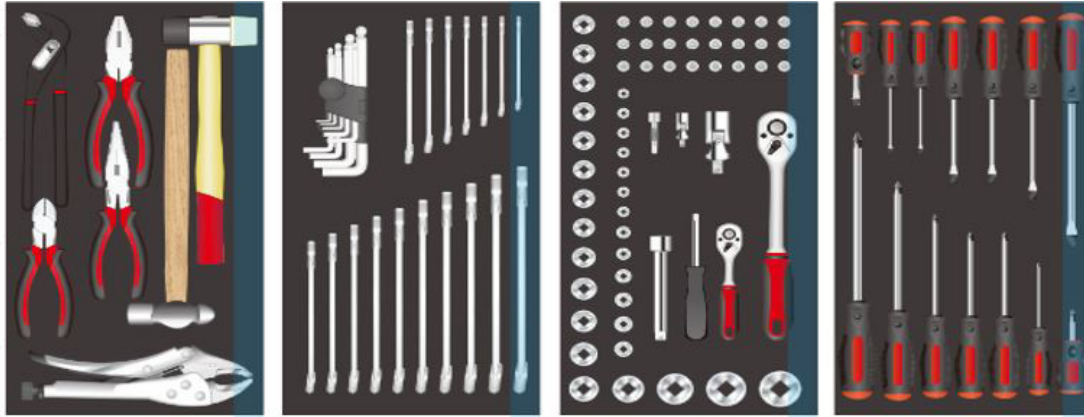

1° cassetto 1st Tray	14 pz/pcs	7pcs	SL Screwdriver	SL 6*38MM-8*175MM-3*75-6*150MM-5*75-4*100MM-5*100MM
		7Pcs	PH Screwdriver	PH0*75-PH1*100MM-PH2*100-PH2*125-PH3*150--PH2*38-PH4*200
		17Pcs	1/2" Socket	10-11-12-13-14-15-16-17-18-19-21-22-23-24-27-30-32MM
		1Pcs	1/2"	1/2"universal joint
		1Pcs	1/2"	1/2" extension Bar-125MM
2° cassetto 2nd Tray	60 pz/pcs	1Pcs	1/2"	1/2" ratchet Handle -72T
		13Pcs	1/4" Socket	4-4.5-5-5.5-6-7-8-9-10-11-12-13-14MM
		1Pcs	1/4"	1/4"universal joint
		1Pcs	1/4"	1/4" extension bar:50mm
		1Pcs	1/4"	1/4"ratchet Handle -72T
		1Pcs	1/4"	1/4"Socket Holder/Spinder handle
		23pcs	1/4"Socket Bit	T8-10-15-20-25-27-30-40-PH1-2-3,PZ1-2-3,SL4-4.5-7,H3-4-5-6-7-8
3° cassetto 3rd Tray	26 pz/pcs	17pcs	6-22mm Combination Wrench	6-7-8-9-10-11-12-13-14-15-16-17-18-19-20-21-22mm
		9Pcs	Ball Point Hex Key sets	1.5-2-2.5-3-4-5-6-8-10MM
4° cassetto 4th Tray	7 pz/pcs	1Pcs	40mm	40mm Rubber Mallet
		1Pcs	500g	500g Machinist Hammer
		1Pcs	8"	Combination Pliers
		1Pcs	8"	Long nose Plies
		1Pcs	7"	Diagonal Pliers
		1Pcs	10"	Locking Pliers
		1Pcs	10"	D4 Groove joint Pliers



## ACCESSORI PER BICI E MOUNTAIN BIKE ACCESSORIES FOR BIKES AND MOUNTAIN BIKES

Cod. 05.088.126

€ 26,00

### RASTRELLIERA PER 2 CICLI 2 BIKE FLOOR STAND APARCAMIENTO PARA 2 BICILETAS

- Costruzione in tubolari in acciaio
- Dimensioni (montata): 600x540x570mm
- Per ruote fino a 63 mm di larghezza
- Adatto per bici con freno a disco
- Peso netto: 4 kg



- Tubular steel construction
- Opened size: 600x540x570mm
- Holds tires up to 63 mm thick
- Suitable for bikes with disc brake
- Net weight: 4 kgs

- Construcción de acero tubular
- Dimensión (montato): 600x540x570mm
- Para ruedas de hasta 63 mm de ancho
- Apto para bicicletas con freno de disco
- Peso neto: 4 kgs

Cod. 05.088.134

€ 37,50

### PORTABICI POSTERIORE PER AUTO/FURGONI REAR BIKE RACK FOR CARS / VANS PORTABICILETAS TRASERO PARA COCHES / FURGONETAS

- Dim. tubo tondo in acciaio 25x1,5 mm;
- Dimensioni: 65X60X50 cm,
- Finitura verniciata a polvere
- 6 cinghie fissano il portapacchi al veicolo
- Può contenere tre pezzi di biciclette
- Capacità massima: 60 kg



- Steel round tube size 25x1.5mm
- Size: 65X60X50cm
- Powder coated finish
- 6 straps to secure the bike carrier
- It can carry up to three bicycles
- Max Capacity: 60kg



- Tamaño de tubo de acero redondo 25x1,5 mm
- Dimensiones: 65X60X50 cm
- Acabado con recubrimiento en polvo
- 6 correas para asegurar el portabicicletas al vehículo
- Puede transportar hasta tres bicicletas.
- Capacidad máxima: 60 kg

Cod. 05.088.125

€ 27,95

### SUPPORTO TELESCOPICO PER BICI, IN ALLUMINIO TELESCOPIC BIKE STAND, IN ALUMINUM SOPORTE DE BICICLETA TELESCÓPICO, DE ALUMINIO



Cod. 05.090.97

€ 45,70



### SET DI 44 UTENSILI PER RIPARAZIONE CICLI E M.BIKE

44 PCS BICYCLE TOOL SET

CAJA DE 44 HERRAMIENTAS  
PARA REPARACIÓN DE BICICLETAS

Cod. 05.073.22

€ 4,98

FINE SERIE  
SELL OUT

COB LED LAMP



160 LUMEN



Min. ordine 12 pz  
Min. order 12 pcs  
Pedido mínimo 12 uds.



Espositore incluso  
Display included  
Exhibidor incluido



Cod. 05.073.21

€ 4,50

FINE SERIE  
SELL OUT

COB PEN LIGHT



80 LUMEN



Espositore incluso  
Display included  
Exhibidor incluido



3 x AAA 1.5V  
minisito incl.



EVERSMART

Cod. 05.060.00

€ 29,90

CAVO DI SOCCORSO ELETTRONICO

protetto contro inversioni e corti circuiti (brevettato)  
conforme normativa CE e SAE

INTELLIGENT BOOSTER CABLE

against inversions and short circuits (patented)  
In conformity with CE and SAE standards

CABLE DE SOCORRO ELECTRÓNICO

protegido contra las inversiones de polaridad y los  
cortocircuitos (con patente) de conformidad  
con las normativas CE y SAE

Cod. 03.000.42

€ 79,00

COMPRESSORE D'ARIA  
AIR COMPRESSOR  
COMPRESOR DE AIRE

MAX  
10.3 BAR

12V 30A



Cod. 05.096.04

€ 4,50

Prezzi netti per quantità  
Net prices for min. q.ty



INPUT 12V - 24V DC  
DUAL OUTPUT:  
5 V DC = 2,1 A  
5 V DC = 1 A

Cod. 05.096.03

€ 10,90

VOLTIMETRO DIGITALE DA AUTO  
DIGITAL VOLTMETER FOR VEHICLES  
VOLTÍMETRO DIGITAL PARA VEHÍCULOS



Permette un controllo costante dello stato della batteria  
attraverso la presa accendisigari. Confezione in blister

It allows to check constantly on the battery status  
through the cigar lighter socket. Supplied in blister  
package

Permette un controllo costante dello stato della batteria  
atráido la presa accendisigari. Confezione en blister

Cod. 03.024.34

€ 34,90

**NUOVO CARICABATTERIE INTELLIGENTE  
NEW SMART BATTERY CHARGER  
NUEVO CARGADOR DE BATERIA INTELIGENTE**

**CBA 400 PRO**



- Corrente di carica: 6V: 2A; 12V: Lenta 2A / Veloce 4A
- Voltaggio della batteria: 6V/12V, Max. Potenza: 70W
- Tensione AC: 220VAC-240VAC, 50Hz
- Tipi di batterie: tutti i tipi di batterie al piombo-acido (WET, MF, Ca/Ca, AGM e GEL)
- Tipo di caricabatterie: 7 fasi, ciclo di ricarica completamente automatico
- Classe di isolamento: IP65
- Cavo: 1,5mt
- Caratteristiche intelligenti di ricarica a 7 fasi
- Funzione DIAGNOSI e RESCUE
- Diverse funzioni di protezione: inversione di polarità / surriscaldamento / cortocircuito / bassa tensione / sovraccarico
- Morsetti a coccodrillo di alta qualità
- Modalità Freddo: per consentire la carica e mantenere le batterie a basse temperature

- Charging current: 6V: 2A; 12V: Slow 2A / Fast 4A
- Battery voltage : 6V/12V, Max. Power: 70W
- Voltage AC: 220VAC-240VAC, 50Hz
- Battery Types: All type of lead-acid batteries WET, MF, Ca/Ca, AGM and GEL)
- Charger type: 7-Step, Fully automatic charging cycle
- Insulation class: IP65
- Cable: 1.5M
- 7-step intelligent charging characteristics
- DIAGNOSIS and RESCUE function
- Various Protection Functions: Reverse polarity / Over heat / Short Circuit / Low voltage / Over charge
- High-quality crocodile clamps
- Cold Mode: to allow charge and maintain batteries at low temperatures

Cod. 05.088.67

€ 27,90

**CARRELLO PORTA GOMME DA NEVE (CON CERCHIONI)  
TIRE STORAGE RACK  
SOPORTE PARA NEUMÁTICOS CON RUEDAS**



- Capacità: 4 pneumatici da 225;
- Capacità: 125 kg
- Struttura in acciaio verniciato
- 5 ruote, 2 con freno
- Confezione standard: 4 carrelli
- Peso unitario: 3,5 kg
- Capacity: 4 tires;
- Load capacity: 125kgs
- Steel tubing with power-coated steel base for strength and durability
- 5 wheels (2 with brake);
- Net weight of one unit: 3.5 Kgs
- Capacidad: 4 neumáticos
- Capacidad de carga: 125kgs
- Tubos de acero con base de acero revestido para la resistencia y la durabilidad
- 5 ruedas (2 con freno)
- Peso neto una unidad: 3,5kgs



Cod. 05.088.60

€ 88,00

**PORTA PNEUMATICI DA PARETE  
WALL TIRE HOLDER  
SOPORTE NEUMATICOS DE PARED**



- Dimensions: 72x74x167cm
- Weight: 15kgs (assembled)
- Dimensiones: 72x74x167cm
- Peso: 15kgs (montado)
- Dimensioni: 72x74x167cm
- Peso: 15kgs (montato)

Cod. 05.088.68

€ 28,70

**SUPPORTO PER PNEUMATICI  
TYRES HOLDER  
SOPORTE NEUMÁTICOS**



- Dimensioni di apertura: 120x44x101cm
- L'altezza è regolabile da 0 a 100cm, asta centrale regolabile
- Il supporto può contenere 8 pneumatici 215/55
- Carico massimo: 150kgs
- Imballo: 121x7x8cm
- Opening dimensions: 120x44x101cm
- adjustable height from 0 to 100 cm, adjustable central bar
- The stand can hold 8 pcs of 215/55 tires
- Maximum load: 150kgs
- Packaging: 121x7x8cm

Cod. 03.036.04

€ 15,00

**TANICA SCARICA OLIO ESAUSTO (15LT)**  
**TANK TO DISCHARGE EXHAUST OIL (15LT)**  
**TANQUE PARA LA DESCARGA DE ACEITE USADO (15LT)**



- Temperatura di lavoro -30°/+80°C
- Comode maniglie anteriore e posteriore
- Sufficiente per tutte le applicazioni
- Working temperature -30°/+80°C
- Comfortable front and rear handles
- Capacity enough for all the applications
- Temperatura de funcionamiento -30°/+80°C
- Cómodas asas, delantera y posterior
- Suficiente para todas las aplicaciones

Cod. 05.008.01

€ 6,50

**VASSOIO MAGNETICO DOPPIO**  
**DOUBLE MAGNETIC PART DISH**  
**BANDEJA MAGNÉTICA DOBLE**

- 240x140 mm



Cod. 05.088.70

€ 20,90

- 450x80x320 mm

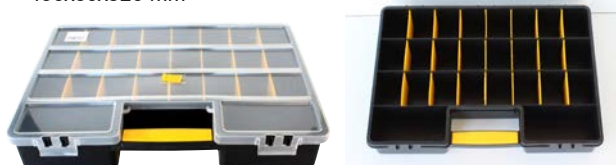

Cod. 05.088.69

€ 16,34

- 360x65x280 mm

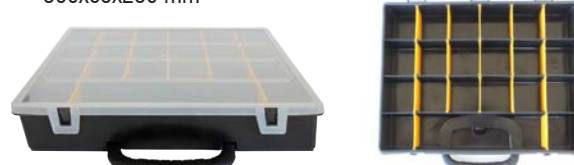

Cod. 05.056.20

€ 3,90

MIN. ORDINE 5 PZ. / MIN. ORDER 5 PCS

**CHIAVE UNIVERSALE PER FILTRI OLIO/GASOLIO**  
regolabile 50-100mm diametro

**OIL FILTER STRAP WRENCH**  
adjustable 50-100mm diameter

**LLAVE UNIVERSAL PARA FILTROS DE ACEITE / DIESEL**  
50-100 mm de diámetro ajustable



Cod. 05.090.98

€ 22,00

**SET DI 36 CHIAVI ESAGONALI CON IMPUGNATURA**  
**36 PCS HEX & TORX KEY SET WITH T-HANDLE**

- 13 Pcs Inch (3/64" - 3/8")
- 13 Pcs Metric (1.27-10mm)
- 9 Pcs Star (T10 -T50)



Cod. 05.088.129

€ 17,50

**COPPIA FINE CORSA IN PLASTICA PER PARCHEGGI**  
52.8x25x5.2 cm; 0.62 kg

**COUPLE OF GARAGE PARKING FLOOR MATS**  
52.8x25x5.2 cm; 0.62 kg

**PAR DE TAPETES DE PLÁSTICO PARA ESTACIONAMIENTO EN GARAJE**  
52.8x25x5.2 cm; 0.62 kg





Cod. 05.088.109W € 136,00

CARRELLO 3 PIANI TIPO PESANTE / 3-LEVEL HEAVY DUTY TROLLEY

- carrello in acciaio verniciato (uso industriale)
- 2 ruote fisse, 2 piroettanti Ø125 mm con freno
- tappeti in gomma antiolio
- portata 300 kg
- Fornito con il kit di montaggio
- trolley in painted steel (industrial use)
- 2 Fixed wheels, 2 pivoting 125 mm diameter with brake
- Anti-oil rubber mats
- capacity 300 kgs
- In mounting kit



Cod. 05.083.03 € 43,70

SGABELLO REGOLABILE CON PORTAUTENSILI  
ADJUSTABLE STOOL WITH TOOL-HOLDER  
TABURETE AJUSTABLE CON PORTAHERRAMIENTAS

- Portata / Capacity / Capacidad: 130Kg
- Altezza max / Max. height / Longitud max: 540mm
- Altezza min / min. height / Longitud min.: 420mm



Cod. 05.083.02 € 26,40

SGABELLO FISSO CON QUATTRO RUOTE E PORTA UTENSILI  
STOOL WITH FOUR WHEELS AND TOOLS-HOLDER  
TABURETE CON CUATRO RUEDAS Y PORTA-HERRAMIENTAS

- Weight / Peso: 3,8kgs
- Dim:360x365x365mm



Cod. 05.088.02 € 62,00

CARRELLO 3 PIANI / 3-LEVEL TROLLEY

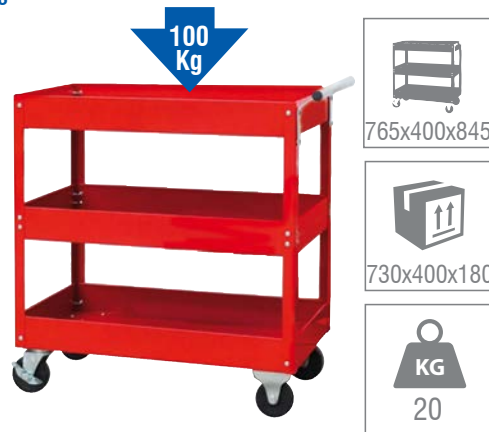

Cod. 05.083.04 € 26,00

CARRELLO PORTA ATTREZZI DA PAVIMENTO SU RUOTE, CON PIANO MAGNETICO  
FLOOR TOOL-HOLDER ON WHEELS, WITH MAGNETIC TOP  
PORTAHERRAMIENTAS DE SUELO SOBRE RUEDAS, CON SUPERFICIE MAGNÉTICA

- Dimensioni: 468mm
- Altezza: 110mm
- Capacità: 100kg
- Peso: 1,4 kg
- Imballo: 47x47x6mm

- Dimensions: 468 mm
- Height: 110 mm
- Capacity: 100kg
- Weight: 1.4 kg
- Imballo: 47x47x6mm

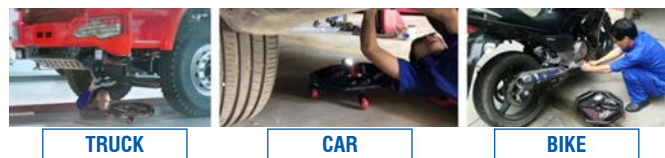

TRUCK

CAR

BIKE

Cod. 05.090.14 € 27,00

SET 12 CACCIAVITI CON ESAGONO ESTERNO  
per una maggior coppia, usando una chiave a bussola

SCREWDRIVER KIT, 12PCS, END-TO-END HEX BLADE  
with outer hexagon for extra torque using a spanner or socket

JUEGO DE 12 DESTORNILLADORES CON HEXÁGONO EXTERNO  
para más torque, usando una llave de tubo





FINE SERIE  
SELL OUT

Cod. 03.000.49

€ 29,00



**PISTOLA DI SOFFIAGGIO CON 6 UGELLI LATERALI**

per pulizia condotti, filtri aria veicoli commerciali, fuoristrada, macchine agricole. Lunghezza utile: 16" (407mm)

**BLOW GUN WITH 6 LATERAL NOZZLES**

for the cleaning of ducts and air filters on commercial vehicles, off-road vehicles, agricultural machinery. Working Length: 16" (407mm)

**PISTOLA DE SOPLADO CON 6 BOQUILLAS LATERALES**

para la limpieza de conductos y filtros de aire en los vehículos comerciales, vehículos todo terreno, maquinaria agrícola. Longitud de trabajo: 16" (407mm)

Cod. 05.084.21

€ 59,00



**KIT CRICCO IDRAULICO 2 TON PER PRONTO INTERVENTO**

con ferma ruote e tappetino, guanti e valigia di trasporto

**2 TON HYDRAULIC JACK FOR EMERGENCY USE**

with wheel stops and mat, gloves and transport case

**GATO HIDRÁULICO DE 2 TONELADAS PARA USO DE EMERGENCIA**

con bloques de ruedas y alfombrilla, guantes y maletín de transporte



- **Idoneo per USO PRIVATO**
- Peso netto/lordo: 9,55/10,96kg
- Dimensioni imballo: 50 x 23 x 16 cm
- **Suitable for PERSONAL USE**
- Peso neto/bruto: 9,55/10,96kg
- Dimensiones del embalaje: 50 x 23 x 16 cm

- **Adecuado para USO PRIVADO**
- Net/gross weight: 9,55/10,96kg
- Package dimensions: 50 x 23 x 16 cm

Cod. 04.052.07

€ 36,00



**RILEVATORE DIGITALE**

cercametalli e rilevatore di cavi elettrici ac

**DIGITAL FINDER**

for metal, ac wiring, wood

**DETECTOR DIGITAL**

de metales y detector de cables electricos ac

**CARATTERISTICHE TECNICHE:**

- Display LCD con indicatore acustico
- Individua rivestimenti in legno fino a 38mm
- Individua tubi in metallo fino a 76mm
- Individua cavi elettrici (AC) fino a 76mm
- Autocalibrazione
- Alimentazione: 1 batteria 9V (non fornita)
- Confezione in blister

**TECHNICAL FEATURES::**

- LCD display and audio indicator
- Wood detection up to 38mm
- Metal pipes detection up to 76mm
- AC live wires detection up to 76mm
- Auto calibration
- Power supply: 6F 22 9V battery (not supplied)
- Blister packaging

NOTE

**PROMO 2022/2**





**MARCO**  
**TOOLS**  
BY SPIN

**PROMO**  
**2022/2**

VALIDITÀ • VALIDITY • VALIDEZ  
01/10/2022 - 31/03/2023

**SPIN s.r.l.**

Via Casalecchio 35/G  
47924 Rimini (RN) Italy  
Tel. +39 0541.730777  
Fax +39 0541.731315  
e-mail: info@spinsrl.it  
www.spinsrl.it

**COMPANY WITH  
QUALITY SYSTEM  
CERTIFIED BY DNV GL  
= ISO 9001 =**

**2022/2**

> Tutte le immagini dei prodotti pubblicate in questo catalogo sono puramente  
indicative e possono essere cambiate senza preavviso.

> All product images published in this catalogue have explanatory purposes  
and can be changed with no warning.

Rivenditore  
Distributor  
Distributeur  
Einzelhändler  
Distribuidor  
Фирма-продавец